



**MATU BROTHERS  
SURGICAL**

# **SURGICAL INSTRUMENT C A T A L O G U E**

**Manufacturer and Exporter  
of Dental Instruments**



**[www.matubrothers.com](http://www.matubrothers.com)**



**01-101**  
TROEMNER  
Size: 245 mm



**01-102**  
DEJERINE  
Size: 200 mm



**01-103**  
DEJERINE  
With Needle  
Size: 210 mm



**01-104**  
TAYLOR  
Size: 195 mm



**01-105**  
BERLINER  
Size: 200 mm

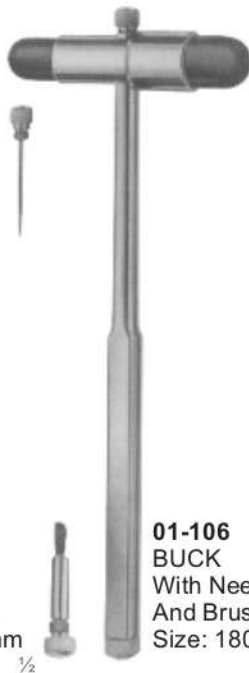

**01-106**  
BUCK  
With Needle  
And Brush  
Size: 180 mm



**01-107**  
RABINER  
With Needle  
And Brush  
Size: 255 mm



**01-108**  
ALY  
Size: 190 mm



**01-109**  
WARTENBERG  
Pinwheel For  
Neurological  
Examination  
Size: 185 mm

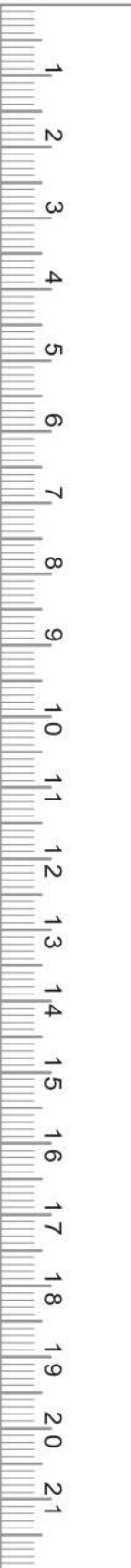

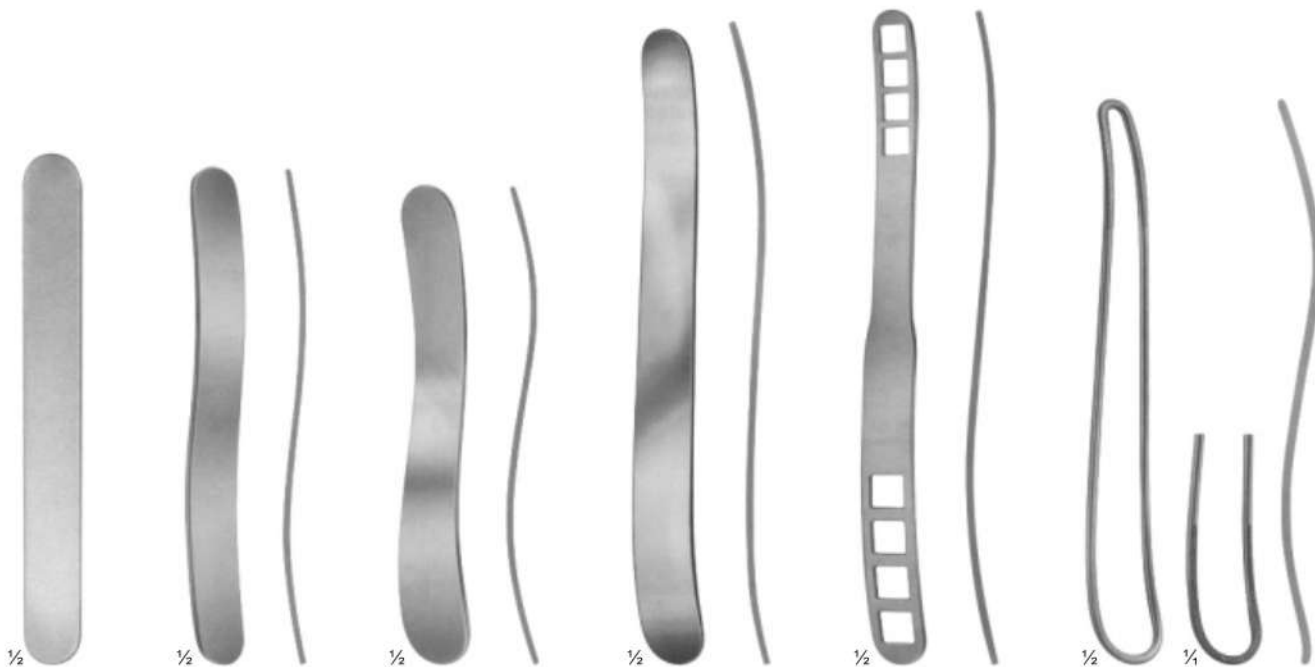

**01-110**  
Size: 150 mm

**01-111**  
Size: 145 mm

**01-112**  
Size: 140 mm

**01-113**  
BUCHWALD  
Size: 180 mm

**01-114**  
BRUENINGS  
Size: 190 mm

**01-115**  
FRENZEL  
Size: 165 mm

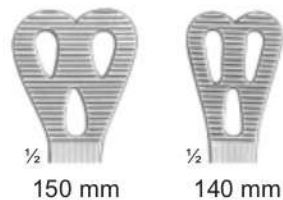

$\frac{1}{2}$   
150 mm

$\frac{1}{2}$   
140 mm



**01-116**  
SIMPLEX  
Size: 110 mm



**01-117**  
STEMBERG  
Size: 120 mm,  
140 mm, 160 mm



**01-118**  
TOBOLD  
Size: 145 mm



**01-119**  
ANDREW  
Size: 110 mm



$\frac{1}{2}$   
**01-120**  
WIEDER

**Tongue Depressors**  
Zungenspatel  
Depresores De Lengua



1/2

**01-121**  
**HEISTER**  
Mouth Gag  
Size: 130 mm



1/2

**01-122**  
**FERGUSSON-ACKLAND**  
Mouth Gag  
Size: 145 mm



1/2

**01-123**  
**DENHARDT**  
Mouth Gag With Silicon  
Inserts, Interchangeable  
Size: 125 mm



1/2

**01-124**  
**ROSER KONIG**  
Mouth Gag  
Size: 160 mm,  
185 mm



1/2

**01-125**  
**YOUNG**  
Size: 165 mm



1/4  
1 Pair Of  
Rubber Pads



1/2

**01-126**  
**COLLIN**  
Size: 160 mm, 170 mm



1/4  
Size: 160 mm



1/4  
Size: 170 mm

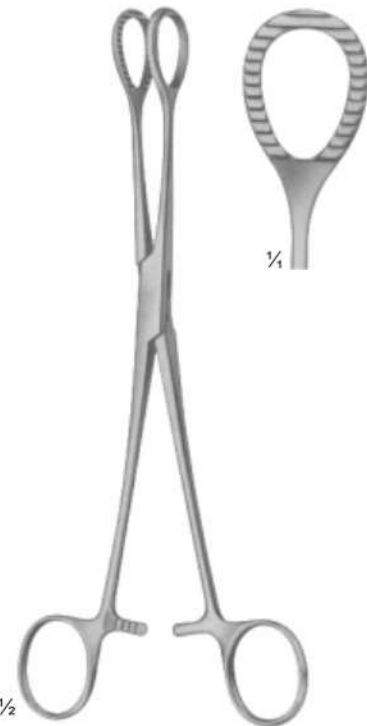

1/2

**01-127**  
**HEYWOOD-SMITH modif.**  
Size: 215 mm

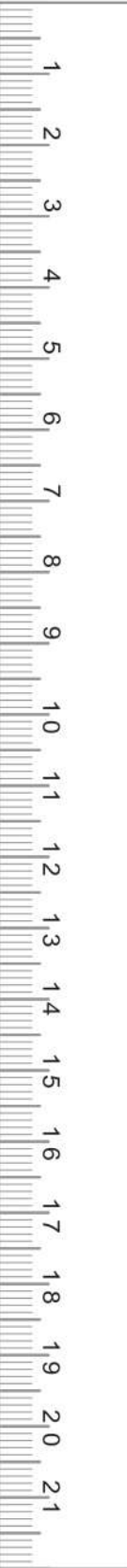

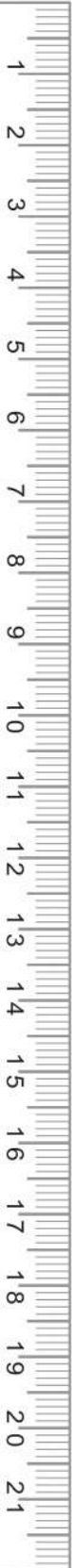

**01-128-130  
MAGILL**



**01-128**  
Infants  
Size: 150 mm



**01-129**  
Children  
Size: 200 mm



**01-130**  
Adults  
Size: 250 mm



**01-131**  
Medium battery handle  
only, 25 mm diam.



**01-132A**  
Spare bulb  
2.7 volt, for  
otoscopes



**01-133-B**  
Spare bulb  
2.6 volt, for  
ophthalmoscopes



**01-134**  
Otoscope Set, Consists Of  
Battery Handle Without Batteries,  
3 Ear Specula, 1 Bulb In Velvet Lined Case



**01-135**  
Diagnostic Set, Otoscope With Three Specula,  
Nasal Speculam, Lamp Holder, Two Laryngeal  
Mirrors, Tongue Blade Holder



1/3

**01-136**  
**MILLER**  
 Laryngoscope Set, Consists Of Battery Handle  
 ( Without Battery ) With Four Miller  
 Laryngoscope Blades

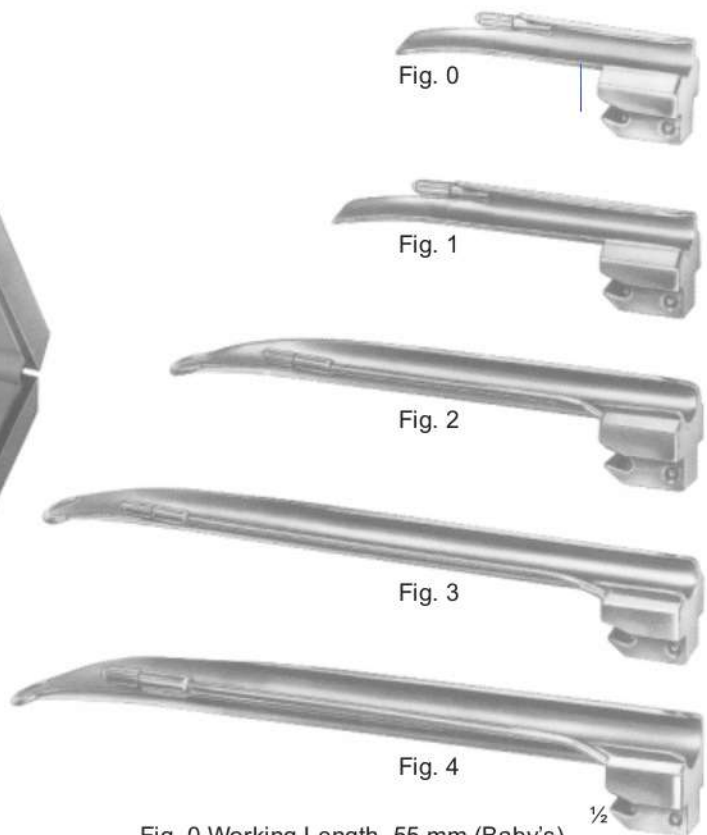

Fig. 0 Working Length, 55 mm (Baby's)  
 Fig. 1 Working Length, 80 mm (Children's)  
 Fig. 2 Working Length, 130 mm (Adolescent's)  
 Fig. 3 Working Length, 170 mm (Women's)  
 Fig. 4 Working Length, 180 mm (Men's)



1/3

**01-137**  
**GUEDEL-NEGUS**  
 Laryngoscope Set, Consists Of Battery Handle  
 ( Without Battery ) With Four Miller  
 Laryngoscope Blades

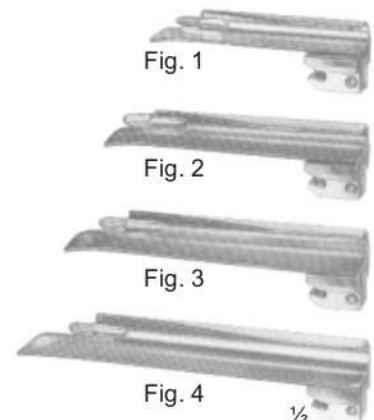

Fig. 1 Working Length, 70 mm (Children's)  
 Fig. 2 Working Length, 90 mm (Adolescent's)  
 Fig. 3 Working Length, 110 mm (Women's)  
 Fig. 4 Working Length, 135 mm (Men's)



**01-138**  
McIntosh  
Laryngoscope Set, Consists Of Battery Handle  
( Without Battery ) With Three McIntosh Blades,  
Fig. 1, Fig. 2, Fig. 3

**01-139**  
McIntosh  
Laryngoscope Set, Consists Of Battery Handle ( Without Battery )  
With Five McIntosh Blades, Fig. 1, Fig. 2, Fig. 3, Fig. 4, Fig. 5



**01-140**  
FOREGGER  
Laryngoscope Set, Consists Of  
Battery Handle ( Without Battery )  
With Three Foregger Blades,  
Fig. 1, Fig. 2, Fig. 3,

**01-141**  
FOREGGER  
Laryngoscope Set, Consists Of  
Battery Handle ( Without Battery )  
With Five Foregger Blades,  
Fig. 1, Fig. 2, Fig. 3, Fig. 4, Fig. 5



Fig. 0 Working Length, 55 mm (Baby's)  
Fig. 1 Working Length, 75 mm (Children's)  
Fig. 2 Working Length, 90 mm (Adolescent's)  
Fig. 3 Working Length, 110 mm (Women's)  
Fig. 4 Working Length, 135 mm (Men's)



Fig. 1 Working Length, 70 mm (Children's)  
Fig. 2 Working Length, 90 mm (Adolescent's)  
Fig. 3 Working Length, 110 mm (Women's)  
Fig. 4 Working Length, 135 mm (Men's)



**01-142**  
Fiber Optic  
Battery Handle

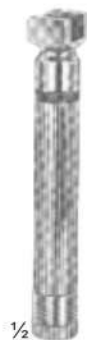

**01-143**  
Fiber Optic  
Battery Handle



**01-144**  
Replacement Lamp  
( Krypton ) 2.5 V



**01-145**  
Replacement Lamp  
( Halogen ) 2.5 V



**01-146**  
 Boley



Metal: **01-147**  
 Wax : **01-148**  
 Double Side Marking  
 Iwanson



**01-149**  
 CAROLL  
 Size: 140 mm



**01-150**  
 TOWNLEY  
 Size: 100 mm



**01-151**  
 BERTILLON  
 Caliper For Measuring The Head  
 Size: 320 mm



**01-152**  
 CASTROVIEJO  
 Caliper



**01-153**  
 MOLTGEN  
 Goniometer



**01-155**  
 Wedge Ruler  
 Size: 150 mm



**01-154**  
 Measuring Scale  
 Size: 500 mm

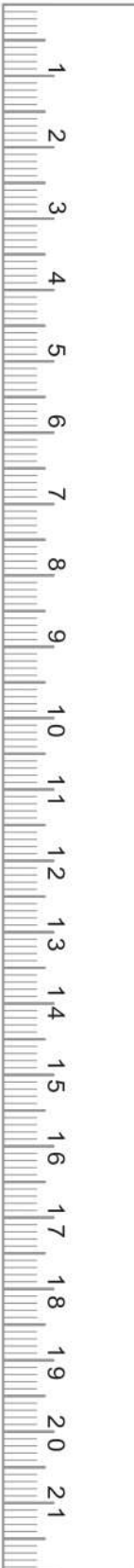





**01-156-165**  
Fig. 1 - 10



**01-156**  
Fig. 1  
30mm



**01-157**  
Fig. 2  
36mm



**01-158**  
Fig. 3  
40mm



**01-159**  
Fig. 4  
45mm



**01-160**  
Fig. 5  
50mm



**01-161**  
Fig. 6  
27mm

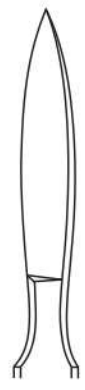

**01-162**  
Fig. 7  
35mm



**01-163**  
Fig. 8  
40mm

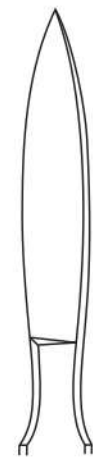

**01-164**  
Fig. 9  
47mm



**01-165**  
Fig. 10  
50mm



**Autopsy & Cartilage Knives**  
**Autopsie- und Knorpel Messer**  
**La Autopsia Y Del Cartilago Cuchillos**

**MATU BROTHERS**  
**SURGICAL**

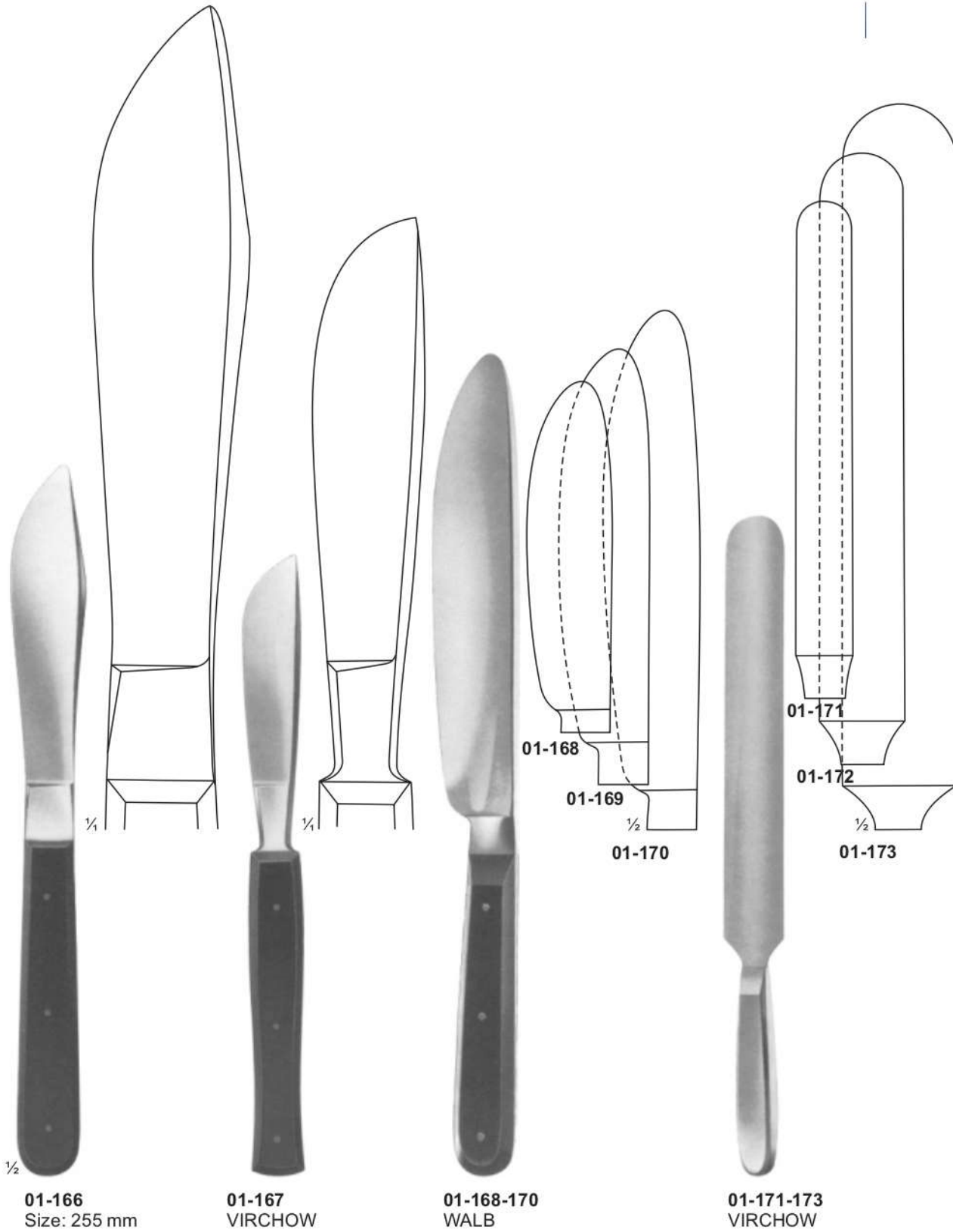

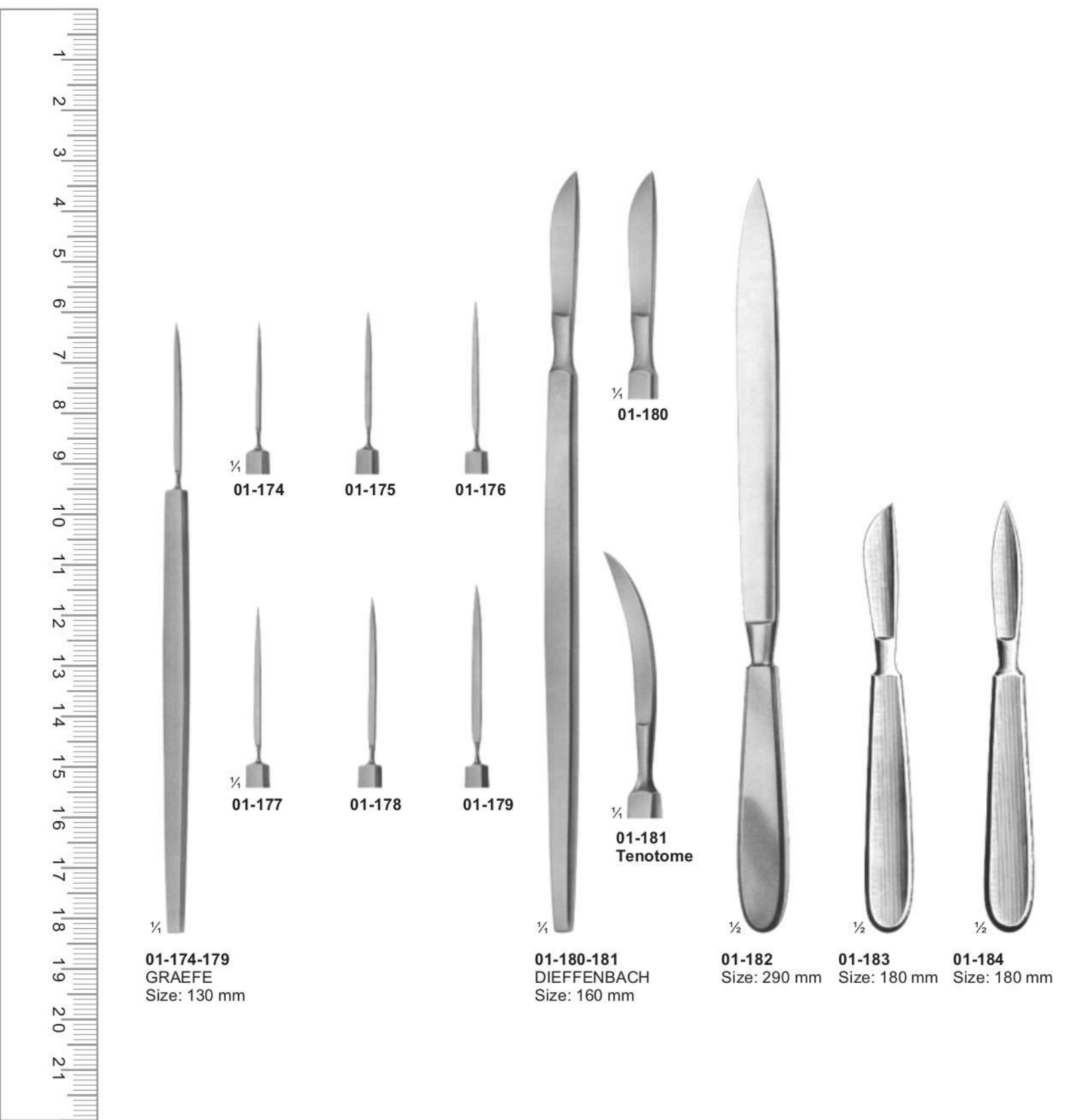

**01-174-179**  
**GRAEFE**  
 Size: 130 mm

**01-174**

**01-175**

**01-176**

**01-177**

**01-178**

**01-179**

**01-180**

**01-181**  
**Tenotome**

**01-180-181**  
**DIEFFENBACH**  
 Size: 160 mm

**01-182**  
 Size: 290 mm

**01-183**  
 Size: 180 mm

**01-184**  
 Size: 180 mm

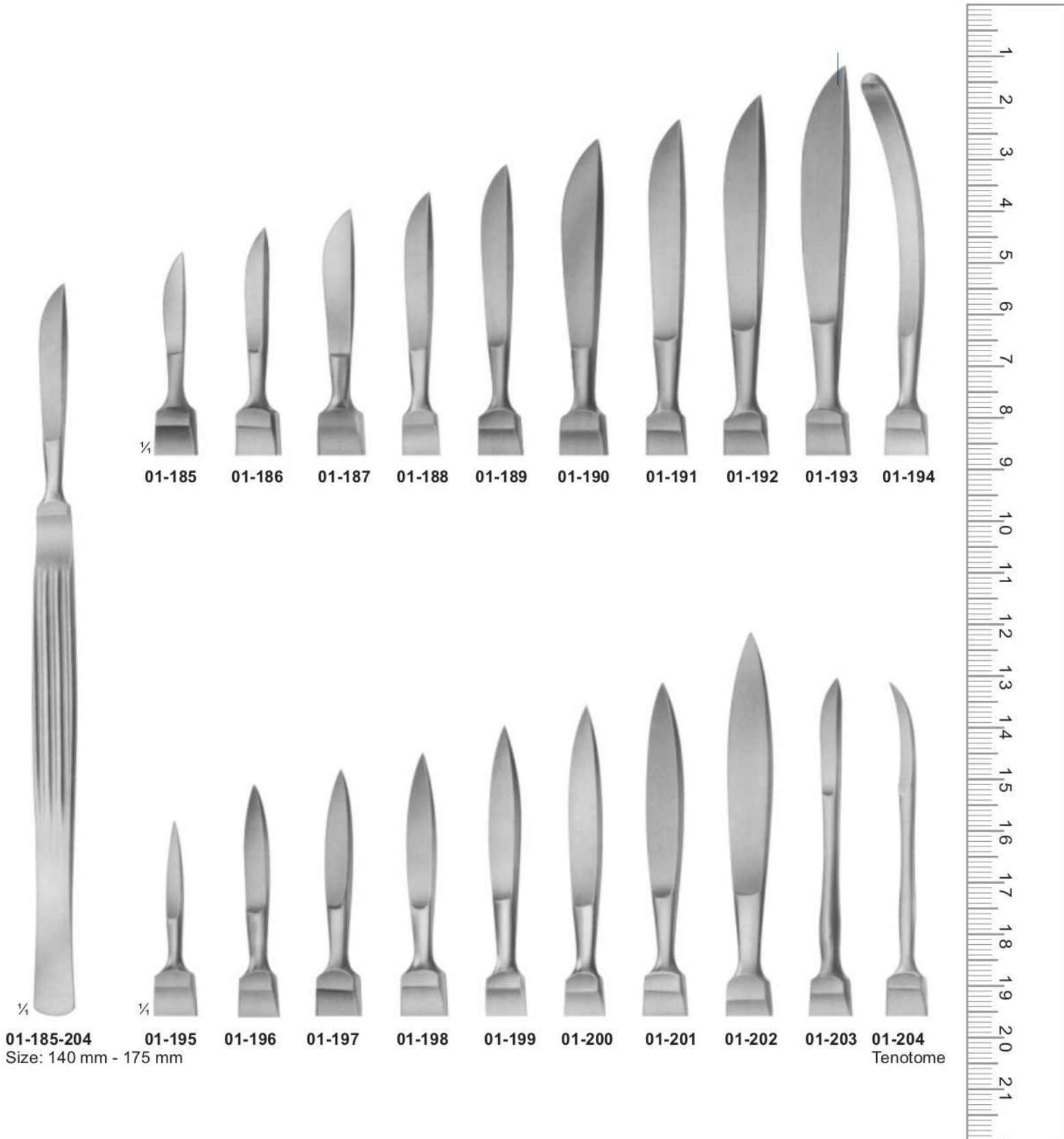

¼

01-185

01-186

01-187

01-188

01-189

01-190

01-191

01-192

01-193

01-194

¼

01-185-204

Size: 140 mm - 175 mm

¼

01-195

01-196

01-197

01-198

01-199

01-200

01-201

01-202

01-203

01-204

Tenotome

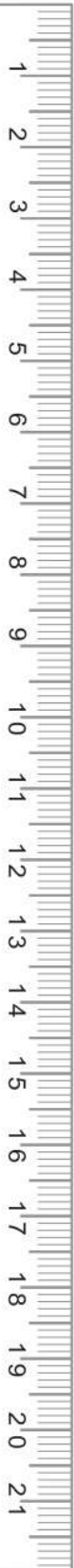

<b>01-205</b> Size: 130 mm	<b>01-209</b> CATLIN Size: 160 mm	<b>01-210</b> LANGENBECK Size: 120 mm	<b>01-211</b> Size: 110 mm	<b>01-212</b> Size: 55 mm	<b>01-213</b> Size: 70 mm	<b>01-214</b> Size: 80 mm	<b>01-215</b> Size: 195 mm
<b>01-206</b> Size: 160 mm	Blade Length	Blade Length	Blade Length	Blade Length	Blade Length	Blade Length	Blade Length
<b>01-207</b> Size: 190 mm	Amputating Knives	Flap Knives	Interosseous Knives	With Raspatory, Wooden Handle	Wooden Handle	Metal Handle	Metal Handle
<b>01-208</b> Size: 200 mm							
Blade Length Amputating Knives							



**Cone Knives, Myomatome, Trigeminal & Tonsil K**  
**Cone Messer, Myomatome, Trigeminus-& Tonsil**  
Cuchillos Del Cono Sur, Myomatome, Cuchillos Del Trigémini

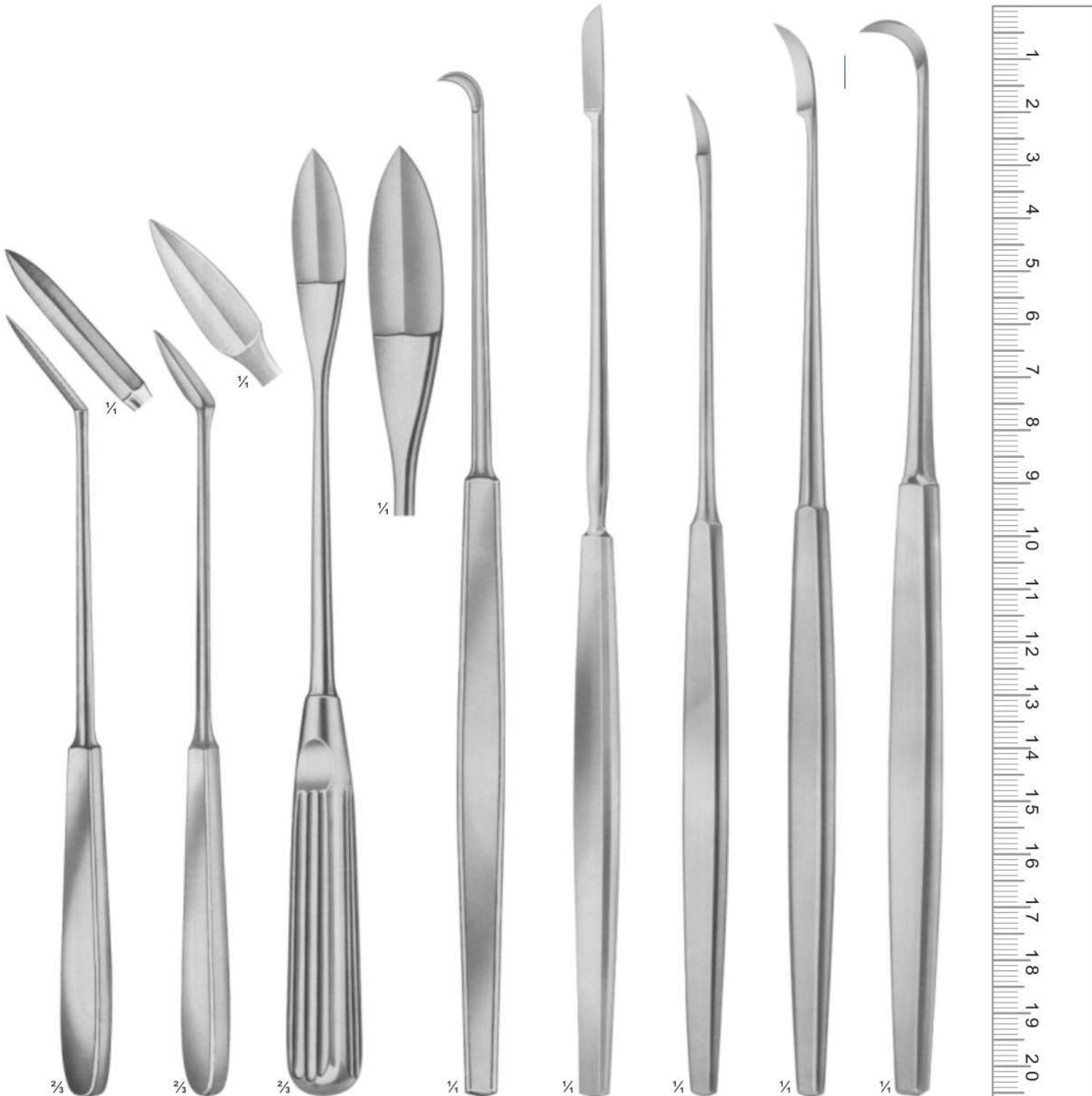

**01-216**  
AYRE  
Size: 235 mm  
Cone Knife

**01-217**  
Size: 230 mm  
Cone Knife

**01-218**  
SEGOND  
Size: 270 mm  
Myomatome

**01-219**  
OLIVECRONA  
Size: 205 mm  
Trigeminal  
Knife

**01-220**  
Size: 230 mm  
Trigeminal  
Knife

**01-221**  
FOWLER  
Size: 200 mm  
Tonsil Knife

**01-222**  
ABRAHAM  
Size: 215 mm  
Tonsil Knife

**01-223**  
BRUENINGS  
Size: 215 mm  
Tonsil Knife

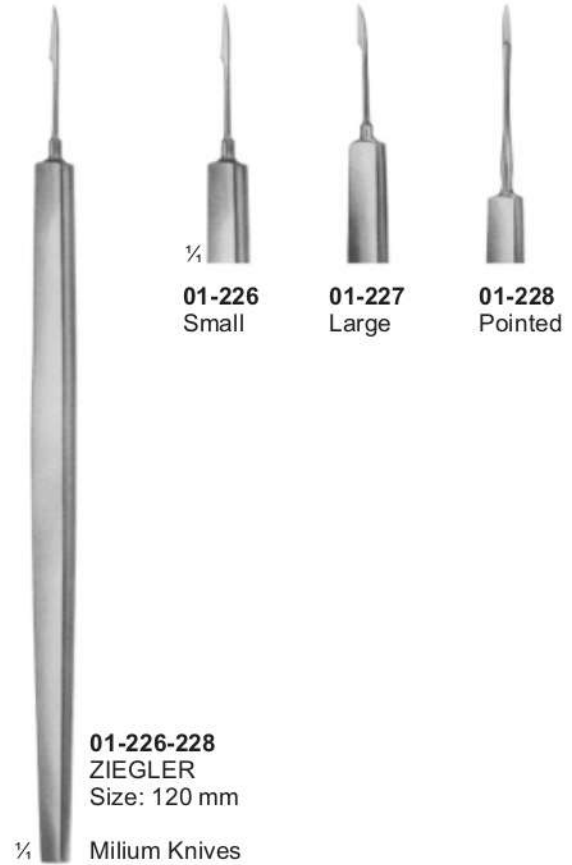
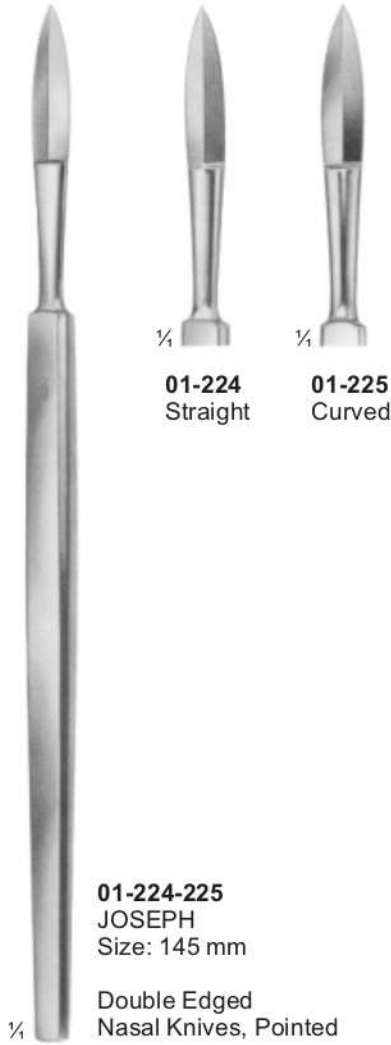



Scalpel Handles  
Skalpellgriffe  
Los Mangos De Bisturí



**01-233**  
STANDARD  
No. 4  
Solid

**01-234**  
Double Handel  
No. 4 + No. 3  
Solid

**01-235**  
No. 4 L  
Straight  
Solid

**01-236**  
No. 4 L  
Solid Angled

**01-237**  
COLLIN  
No. 8  
Hollow

**01-238**  
COLLIN  
No. 9  
Hollow

**01-239**  
Plastic



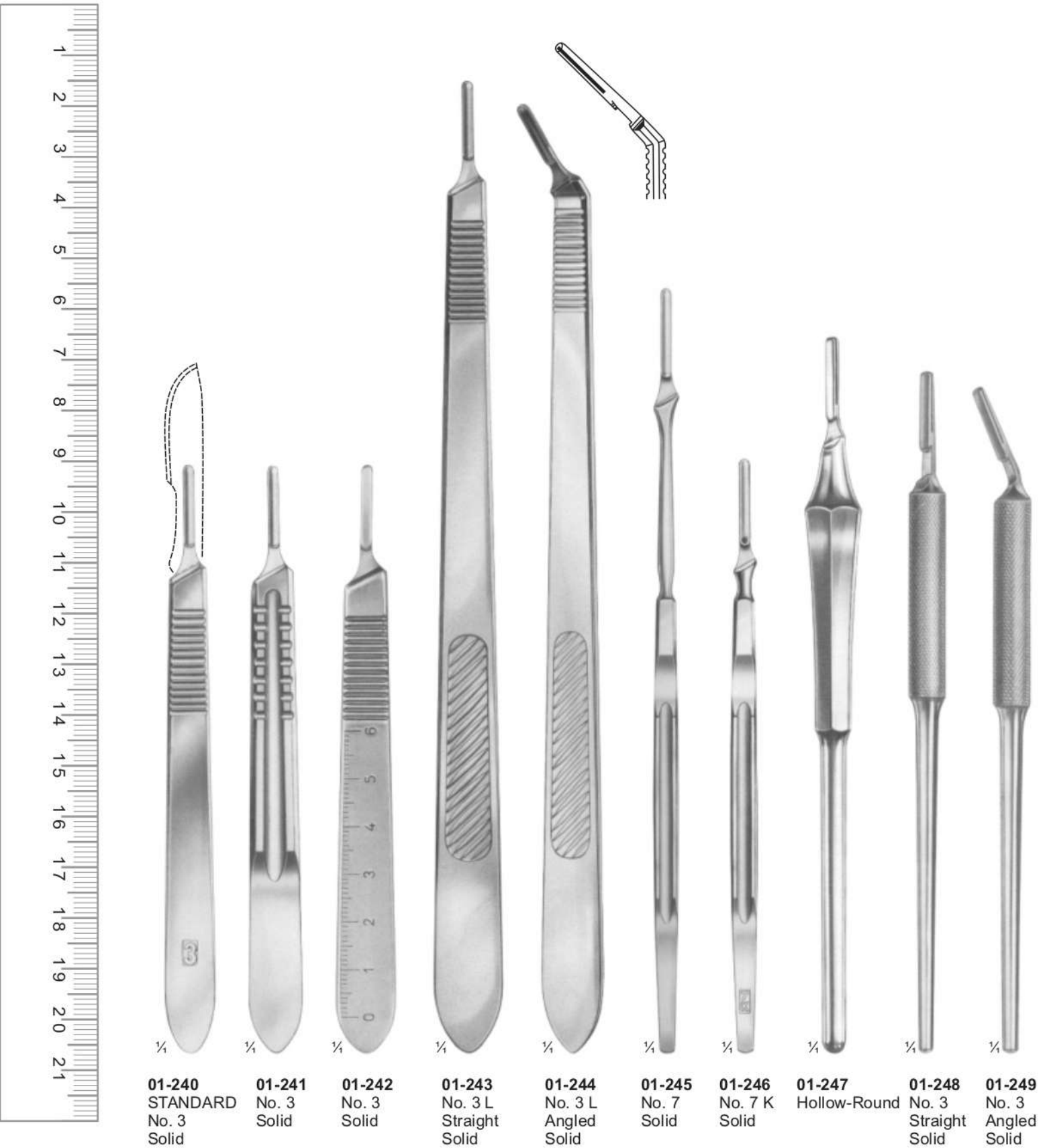



**Micro Scissors, "spring Type" Flat Handles**  
**Micro Scissors, "spring Typ" Flache Griffe**  
**Tijeras Micro, "tipo De Primavera" Flat Maneja**

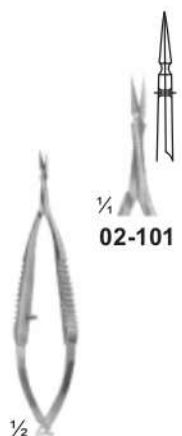

**02-101-103**  
**VANNAS**  
Size: 85 mm



**02-101**



**02-102**



**02-103**



**02-104-105**  
**CASTROVIEJO**  
Size: 95 mm



**02-104**



**02-105**

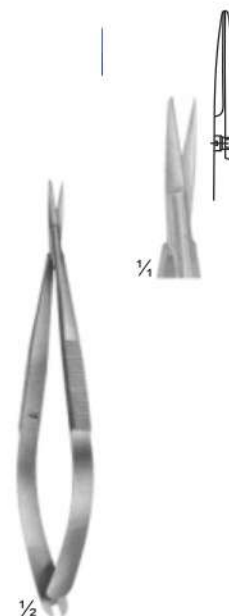

**02-106**  
**NOYES**  
Size: 125 mm



**02-106**



**02-107 - 108**  
**WECKER**  
Eye Scissor  
Size: 110 mm



**02-107**



**02-108**

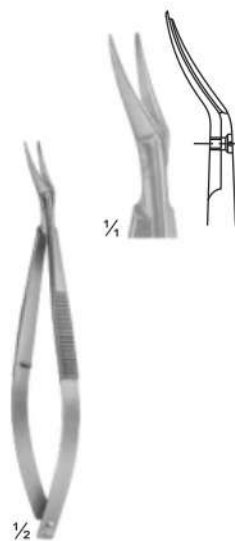

**02-109**  
**CASTROVIEJO**  
Eye Scissor  
Size: 115 mm



**02-109**



**02-110- 111**  
**CASTROVIEJO**  
Eye Scissor  
Size: 110 mm



**02-110**



**02-111**



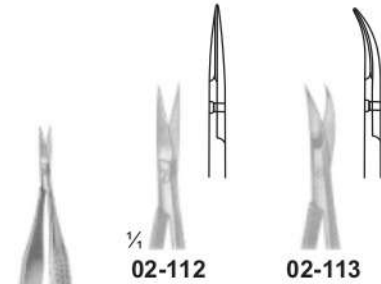
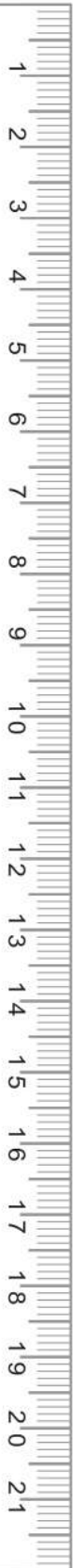

**02-112 - 113**  
Size: 120 mm

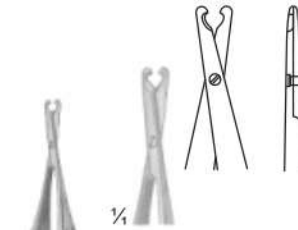

**02-114**  
BIEMER  
Vein Scissor  
Size: 130 mm

**02-115**  
Size: 160 mm

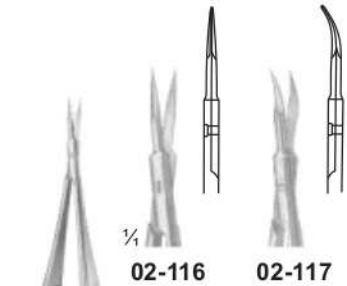

**02-116 - 117**  
VANNAS  
Size: 160 mm

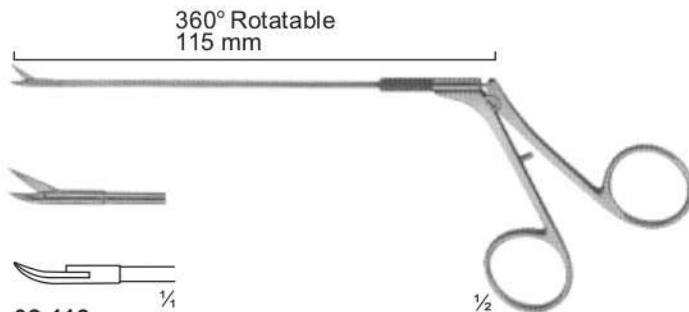

**02-118**  
CASPAR  
Micro Scissor Curved  
Size: 115 mm



**02-119- 121**  
Micro Dissecting Scissor  
Size: 145 mm



Micro Scissors, "spring Type" Bayonet Shape  
Micro Scissors, "frühlings-typ" Shape-bajonet  
Tijeras Micro, "tipo De Primavera" Bayonet Fo



1/4

1/2

**02-122**  
YASARGIL  
Size: 245 mm



1/4

**02-123**



1/2

**02-123 - 124**  
Laterally Angled  
Size: 200 mm



1/4

**02-124**



1/2

**02-125**  
Laterally Angled  
Size: 190 mm

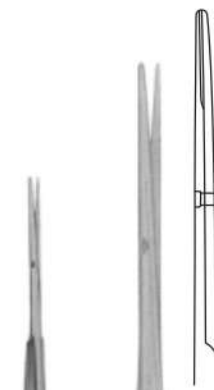

1/4

**02-126**



1/2

**02-126-127**  
YASARGIL  
Size: 225 mm



1/4

**02-127**



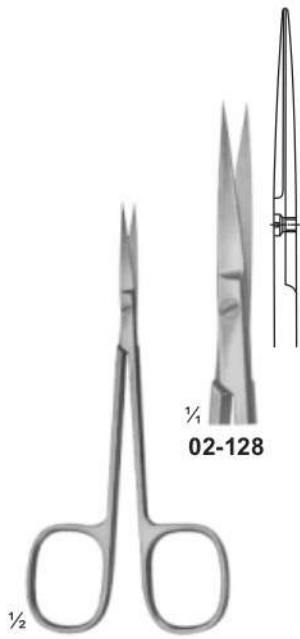
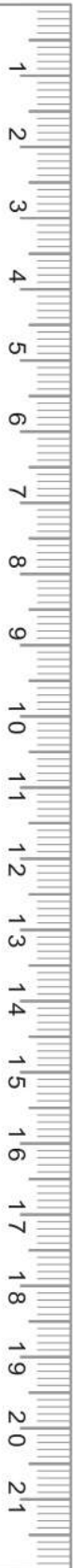

**02-128**



**02-129**

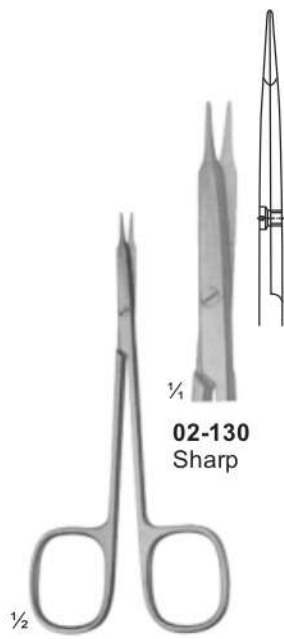

**02-130**  
Sharp

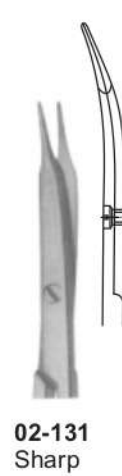

**02-131**  
Sharp



**02-132**  
Blunt



**02-133**  
Blunt

**02-128 - 129**  
Size: 120 mm

**02-130 - 133**  
STEVENS  
Dissecting Scissors  
Size: 115 mm

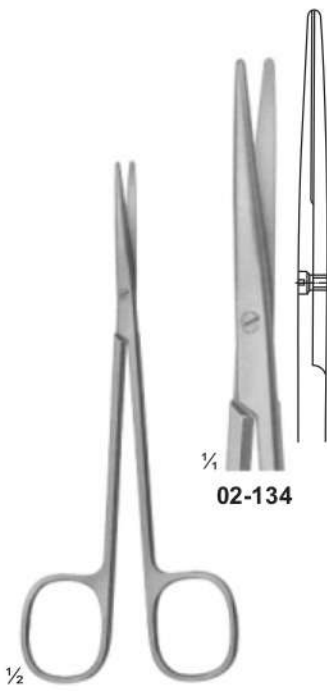

**02-134**



**02-135**

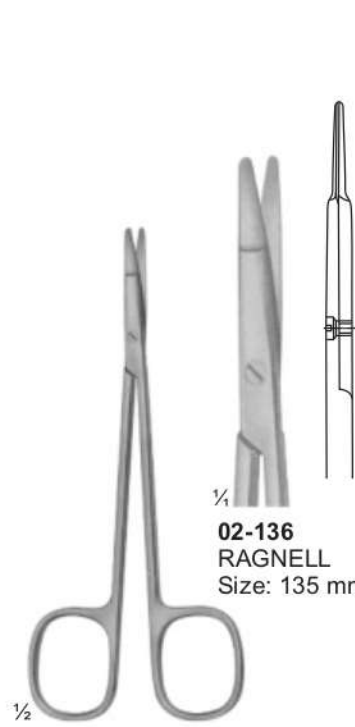

**02-136**  
RAGNELL  
Size: 135 mm



**02-137**  
RAGNELL  
Size: 135 mm



**02-138**  
RAGNELL  
Size: 150 mm

**02-134 - 135**  
METZENBAUM  
Dissecting Scissors  
Size: 145 mm

**02-136 - 138**  
Special flat points for  
dissecting and  
undermining the skin  
Size: 145 mm



Micro Scissors, "spring Type" Bayonet Shape  
Micro Scissors, "frühlings-typ" Shape-bajonet  
Tijeras Micro, "tipo De Primavera" Bayonet Fo



¼

½

**02-122**  
YASARGIL  
Size: 245 mm



¼



**02-123 - 124**  
Laterally Angled  
Size: 200 mm



¼



½

**02-125**  
Laterally Angled  
Size: 190 mm

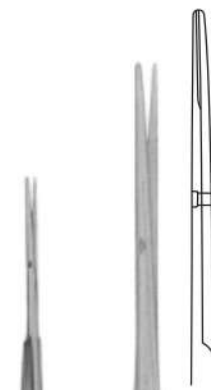

¼



½

**02-126- 127**  
YASARGIL  
Size: 225 mm



¼





1/2

**02-149 - 151**  
Fine Operating Scissors  
Size: 120 mm

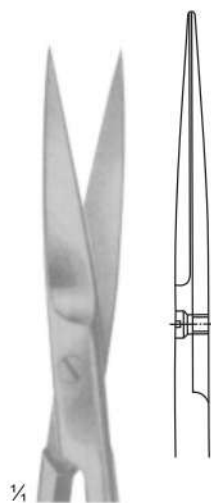

1/4

**02-149**

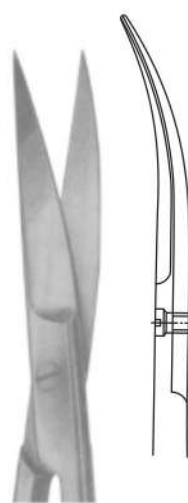

**02-150**

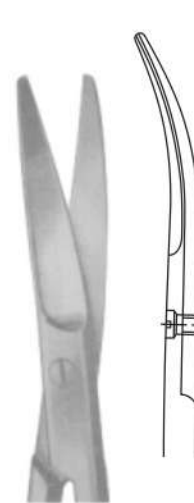

**02-151**



1/2

**02-152 - 155**  
Fine Operating Scissors  
Size: 130 mm

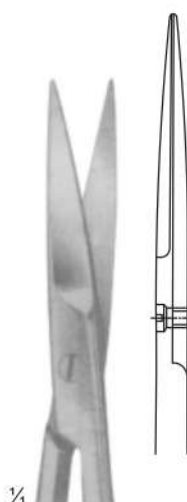

1/4

**02-152**

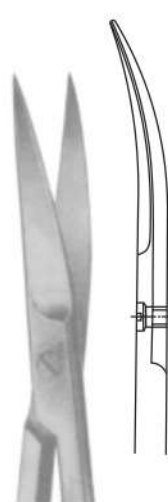

**02-153**

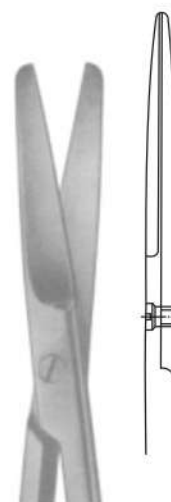

**02-154**

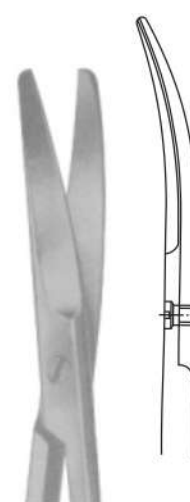

**02-155**

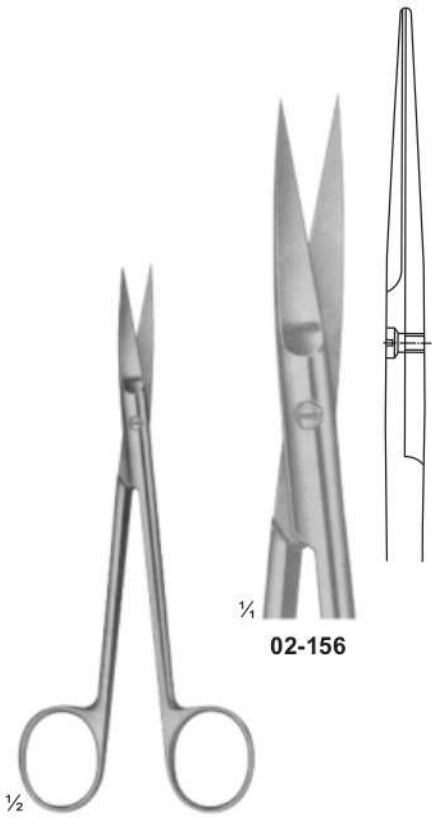

02-156  
02-157

02-156 - 157  
JOSEPH  
Size: 150 mm

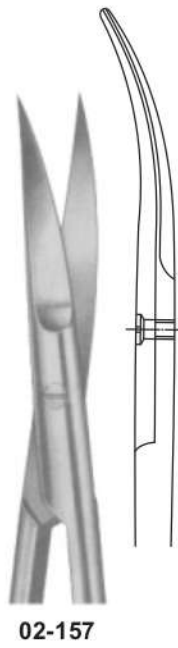

02-157

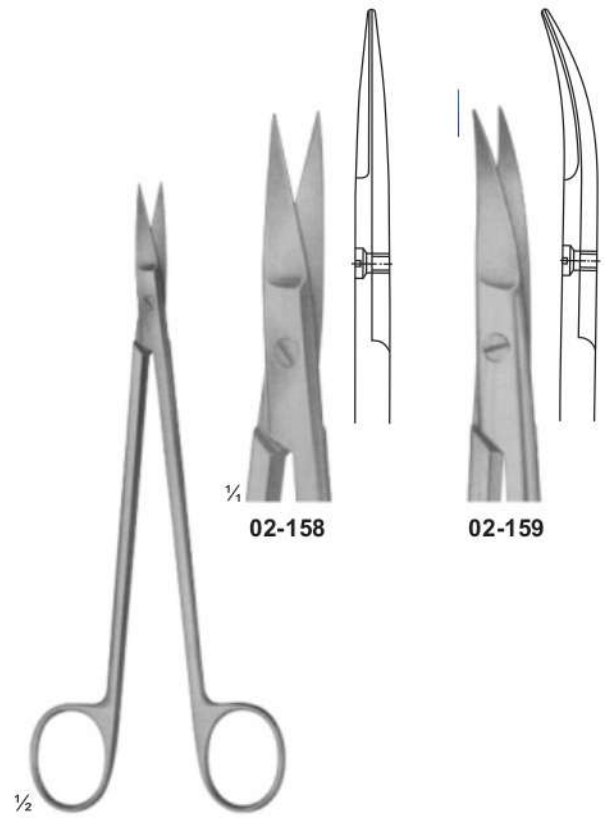

02-158  
02-159

02-158 - 159  
KELLY  
Size: 175 mm



02-160  
QUINBY  
Size: 130 mm

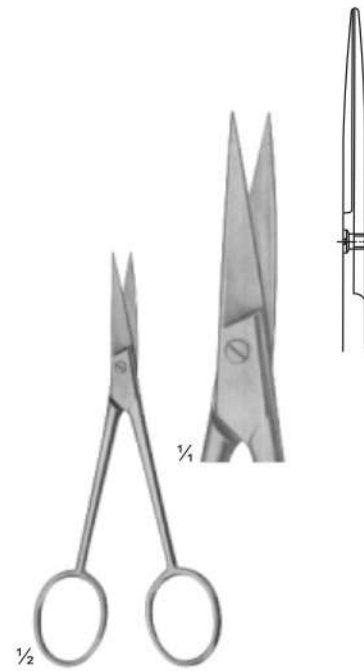

02-161  
Dissecting  
Size: 110 mm





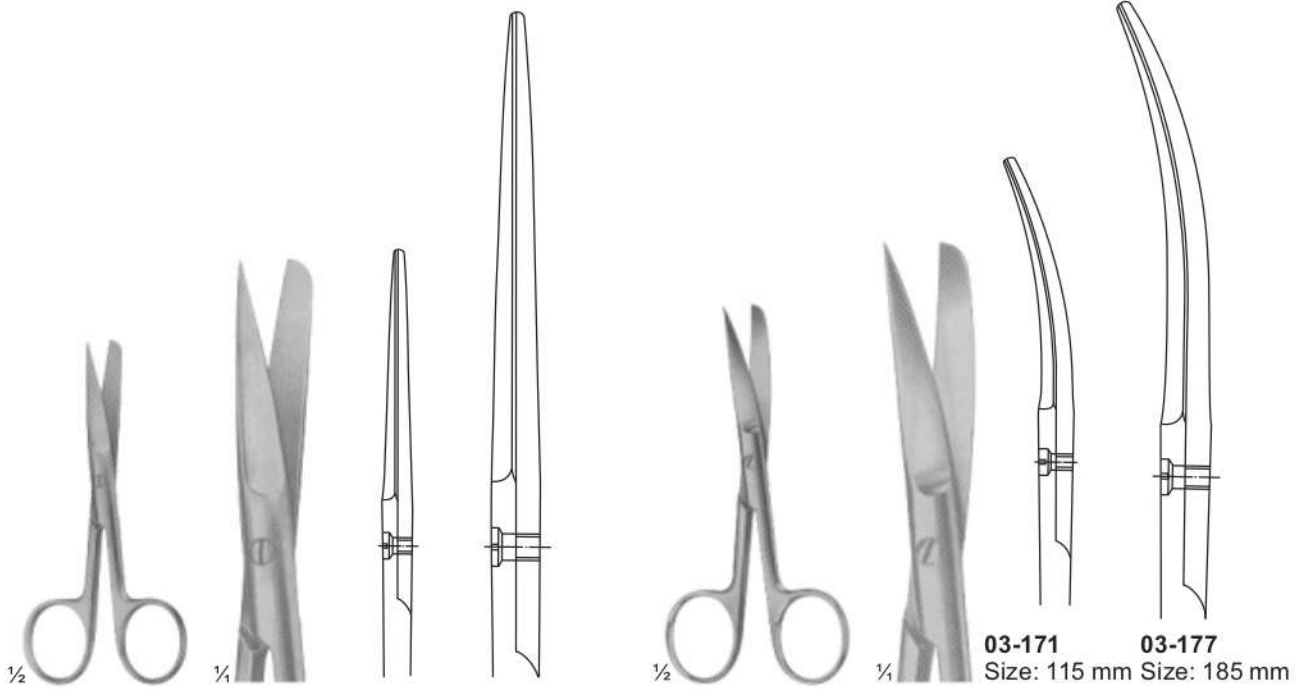
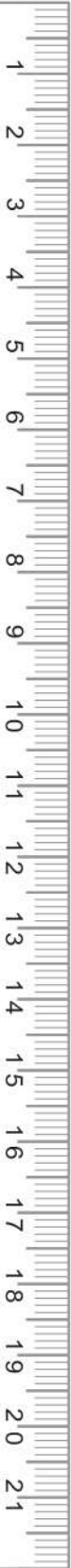

**02-162 - 170 (Standard Types)**  
02-162 (105 mm)  
02-163 (115 mm)  
02-164 (130 mm)  
02-165 (145 mm)  
02-166 (150 mm)  
02-167 (165 mm)  
02-168 (175 mm)  
02-169 (185 mm)  
02-170 (200 mm)

**02-162** Size: 105 mm  
**02-170** Size: 200 mm

**02-171 - 177 (Standard Types)**  
02-171 (115 mm)  
02-172 (130 mm)  
02-173 (145 mm)  
02-174 (150 mm)  
02-175 (165 mm)  
02-176 (175 mm)  
02-177 (185 mm)

**03-171** Size: 115 mm  
**03-177** Size: 185 mm

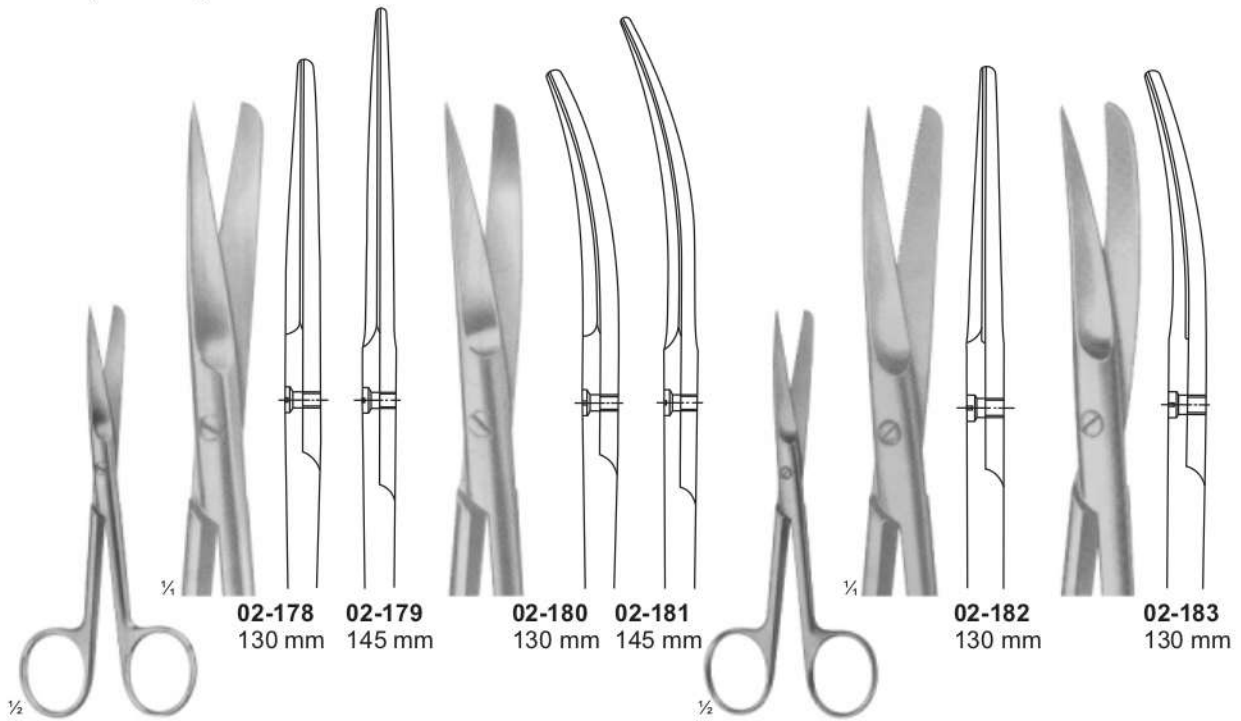

**02-178 - 181**  
Slender Types

**02-178** 130 mm  
**02-179** 145 mm

**02-180** 130 mm  
**02-181** 145 mm

**02-182 - 183**  
For Wound Edges  
1 Blade Serrated

**02-182** 130 mm

**02-183** 130 mm

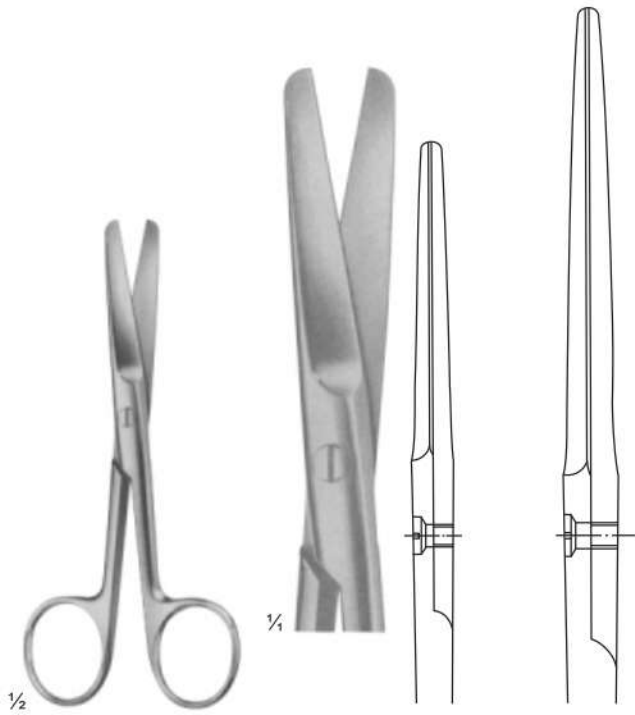

**02-184** Size: 130 mm  
**02-188** Size: 175 mm

- 02-184 - 188 (Standard Types)**  
**02-184** ( 130 mm )  
**02-185** ( 145 mm )  
**02-186** ( 150 mm )  
**02-187** ( 165 mm )  
**02-188** ( 175 mm )

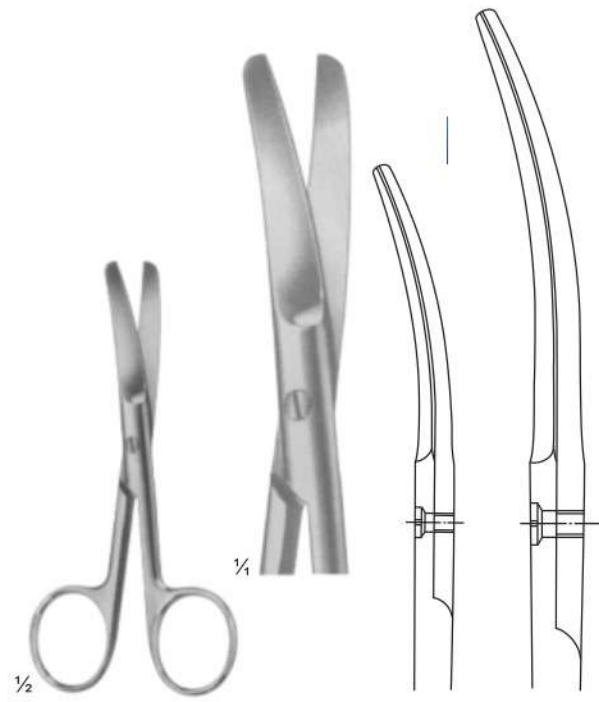

**02-189 - 194 - COOPER** Size: 115 mm  
**02-189** Size: 115 mm  
**02-194** Size: 175 mm

- 02-189 - 194 - COOPER**  
**02-189** ( 115 mm )  
**02-190** ( 130 mm )  
**02-191** ( 145 mm )  
**02-192** ( 150 mm )  
**02-193** ( 165 mm )  
**02-194** ( 175 mm )



**02-195** Size: 115 mm  
**02-199** Size: 165 mm

- 02-195 - 199**  
**Standard Types**  
**02-195** ( 115 mm )  
**02-196** ( 130 mm )  
**02-197** ( 145 mm )  
**02-198** ( 150 mm )  
**02-199** ( 165 mm )

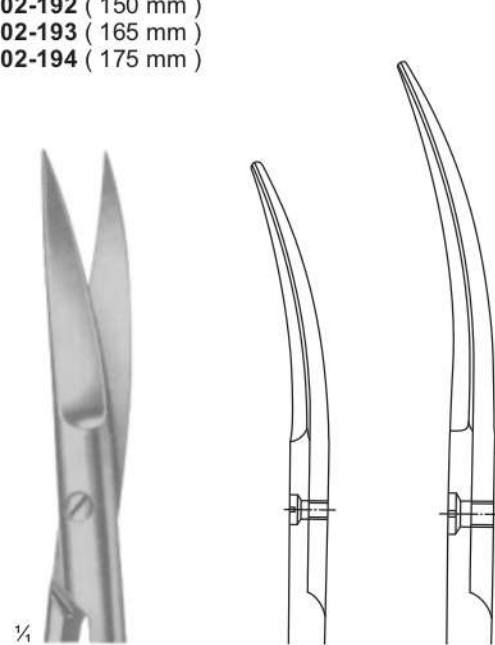

**02-200 - 203** Size: 115 mm  
**02-200** Size: 115 mm  
**02-203** Size: 150 mm

- 02-200 - 203**  
**Standard Types**  
**02-200** ( 115 mm )  
**02-201** ( 130 mm )  
**02-202** ( 145 mm )  
**02-203** ( 150 mm )

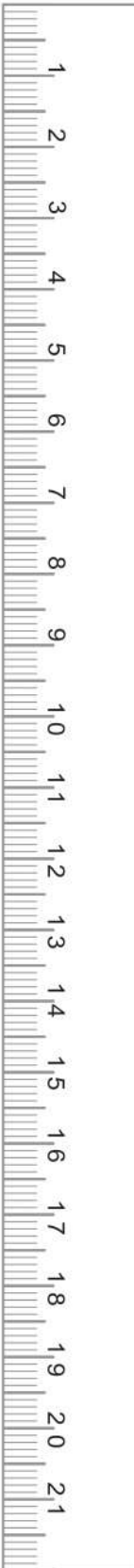



**02-204 - 206**  
DEAVER  
With flat lock

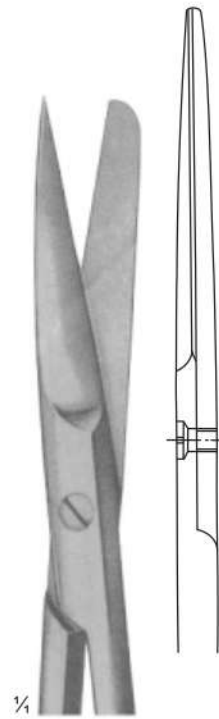

**02-204**  
Size: 145 mm

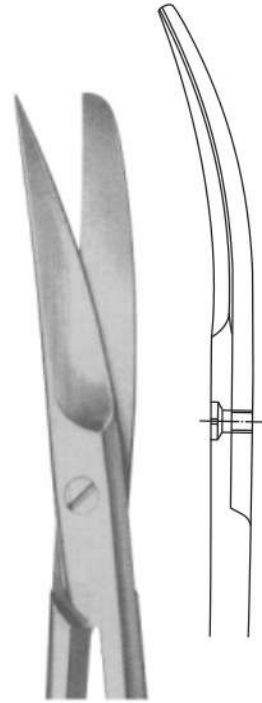

**02-205**  
Size: 145 mm

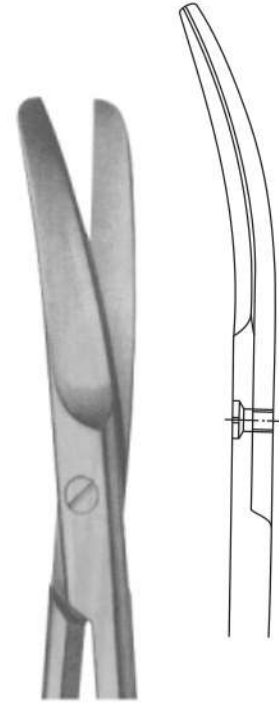

**02-206**  
Size: 145 mm



**02-207 - 209**  
Incision Scissors

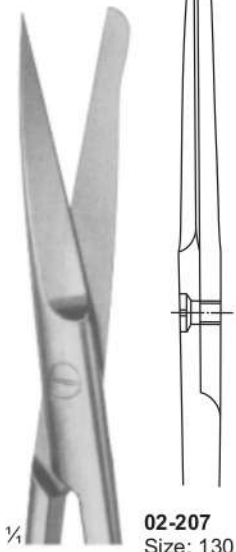

**02-207**  
Size: 130 mm

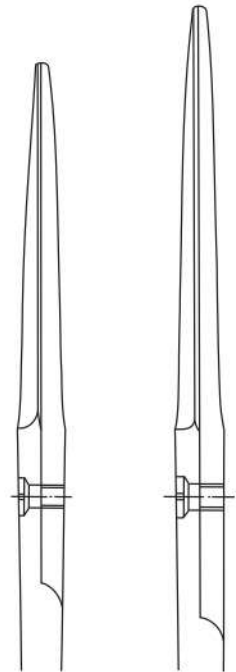

**02-208**  
Size: 145 mm

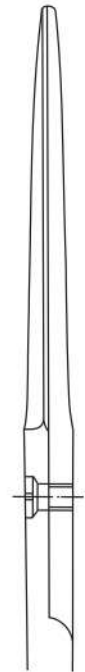

**02-209**  
Size: 165 mm



**02-210**  
SYSTRUNK  
Nail Splitting Scissors

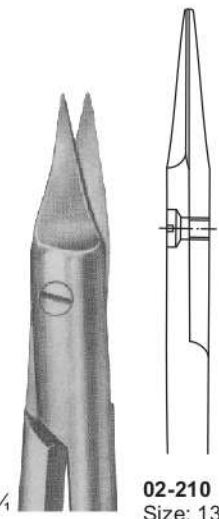

**02-210**  
Size: 130 mm

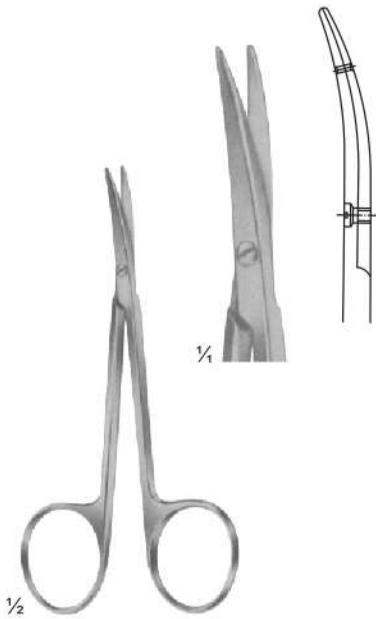

**02-211**  
**LITTLER**  
 Dissecting Scissors  
 Tips with eye for suture  
 Size: 115 mm

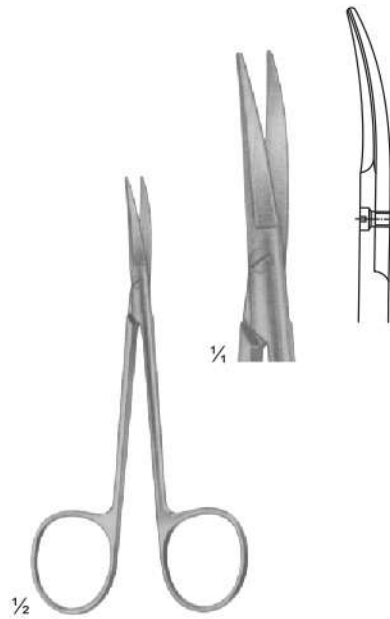

**02-212**  
**COTTLE**  
 Bulldog Scissors  
 Size: 115 mm

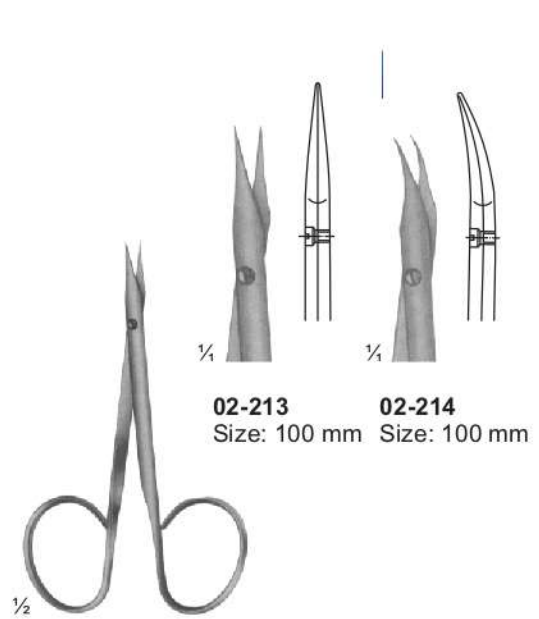

**02-213**      **02-214**  
 Size: 100 mm    Size: 100 mm

**02-213 - 214**  
**STEVENS**  
 Vessel and tendon Scissors  
 Size: 100 mm

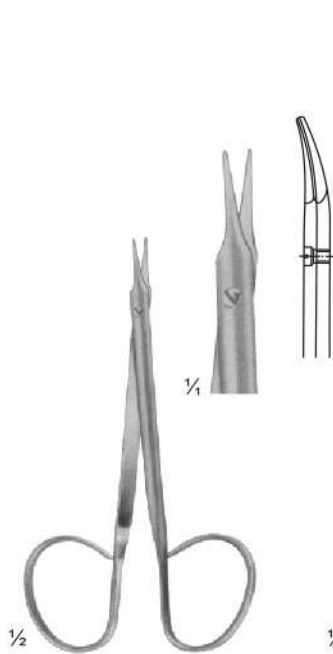

**02-215**  
**STEVENS**  
 Fine Dissecting Scissors  
 Size: 110 mm

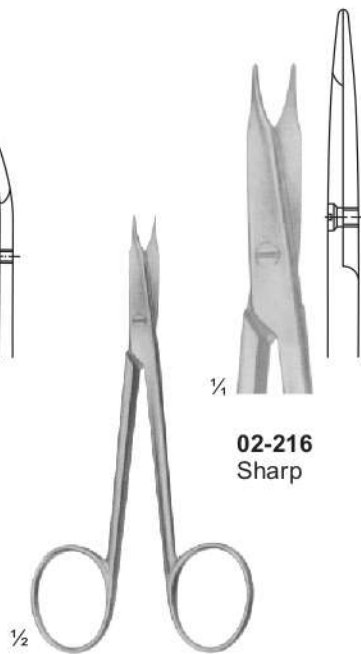

**02-216 - 219**  
**STEVENS**  
 Vessel and tendon Scissors  
 Size: 110 mm

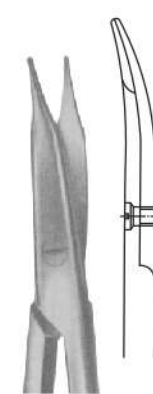

**02-217**  
 Sharp



**02-218**  
 Blunt

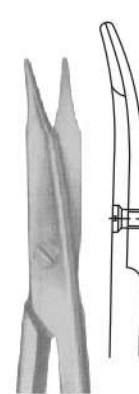

**02-219**  
 Blunt



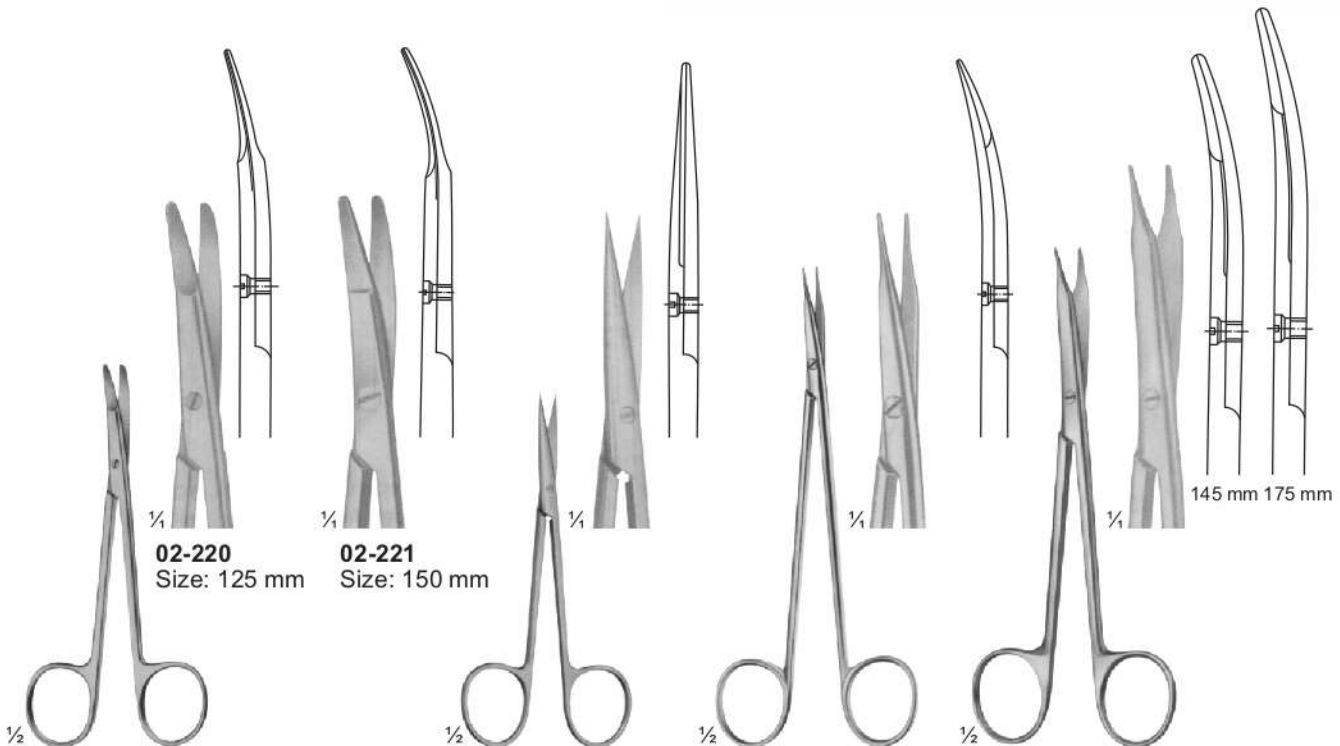

**02-220**  
Size: 125 mm

**02-221**  
Size: 150 mm

$\frac{1}{2}$

$\frac{1}{2}$

$\frac{1}{2}$

145 mm 175 mm

**02-220 - 221**  
KILNER  
Special flat points for dissecting and undermining the skin

**02-222**  
KILNER  
Fine dissecting scissors  
Size: 115 mm

**02-223**  
JAMESON  
Dissecting scissors  
Size: 150 mm

**02-224**  
REYNOLDS  
Dissecting scissors  
Size: 145 - 175 mm

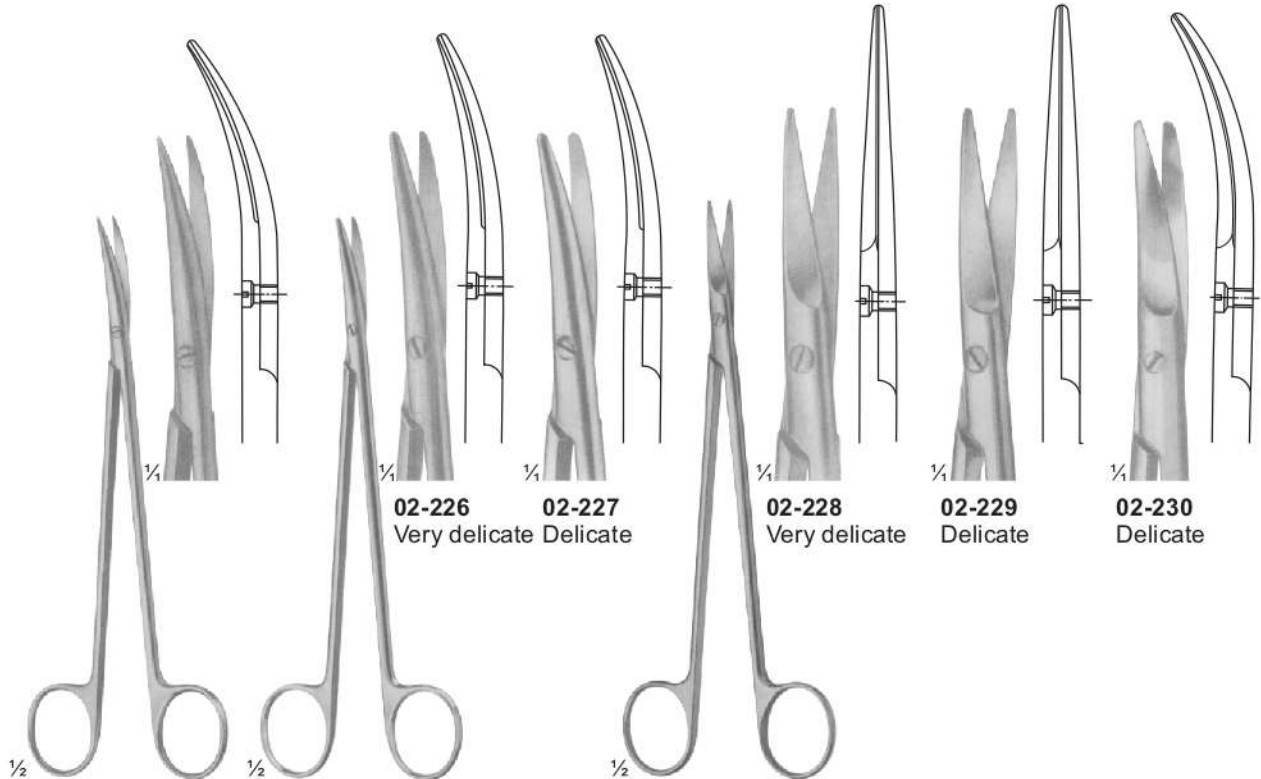

**02-226** Very delicate  
**02-227** Delicate

**02-228** Very delicate

**02-229** Delicate

**02-230** Delicate

**02-225**  
DE BAKEY  
Ateriotomy scissors  
Size: 175 mm

**02-226 - 227**  
TOENNIS ADSON  
Dissecting scissors  
Size: 175 mm

**02-228 - 230**  
TOENNIS  
Dissecting scissors  
Size: 150 mm



Dissecting & Surgical Scissors  
Anatomische Und Chirurgische Schere  
La Disección Y Tijeras Quirúrgicas

**02-231**  
Size: 115 mm

**02-232**  
Size: 135 mm

**02-233**

**02-234**

**02-231 - 232**  
FOMON  
Lower lateral scissors

**02-233 - 234**  
LANDOLT  
Enucleation scissors  
Size: 120 mm

**02-235**  
Size: 140 mm

**02-238 - 240**  
MAYO  
02-238 (140 mm)  
02-239 (155 mm)  
02-240 (170 mm)

**02-241**  
Size: 140 mm

**02-243 - 244**  
MAYO-STILLE  
02-243 (140 mm)  
02-244 (170 mm)

**02-235 - 237**  
MAYO  
02-235 (140 mm)  
02-236 (155 mm)  
02-237 (170 mm)

**02-241 - 242**  
MAYO-STILLE  
02-241 (140 mm)  
02-242 (170 mm)

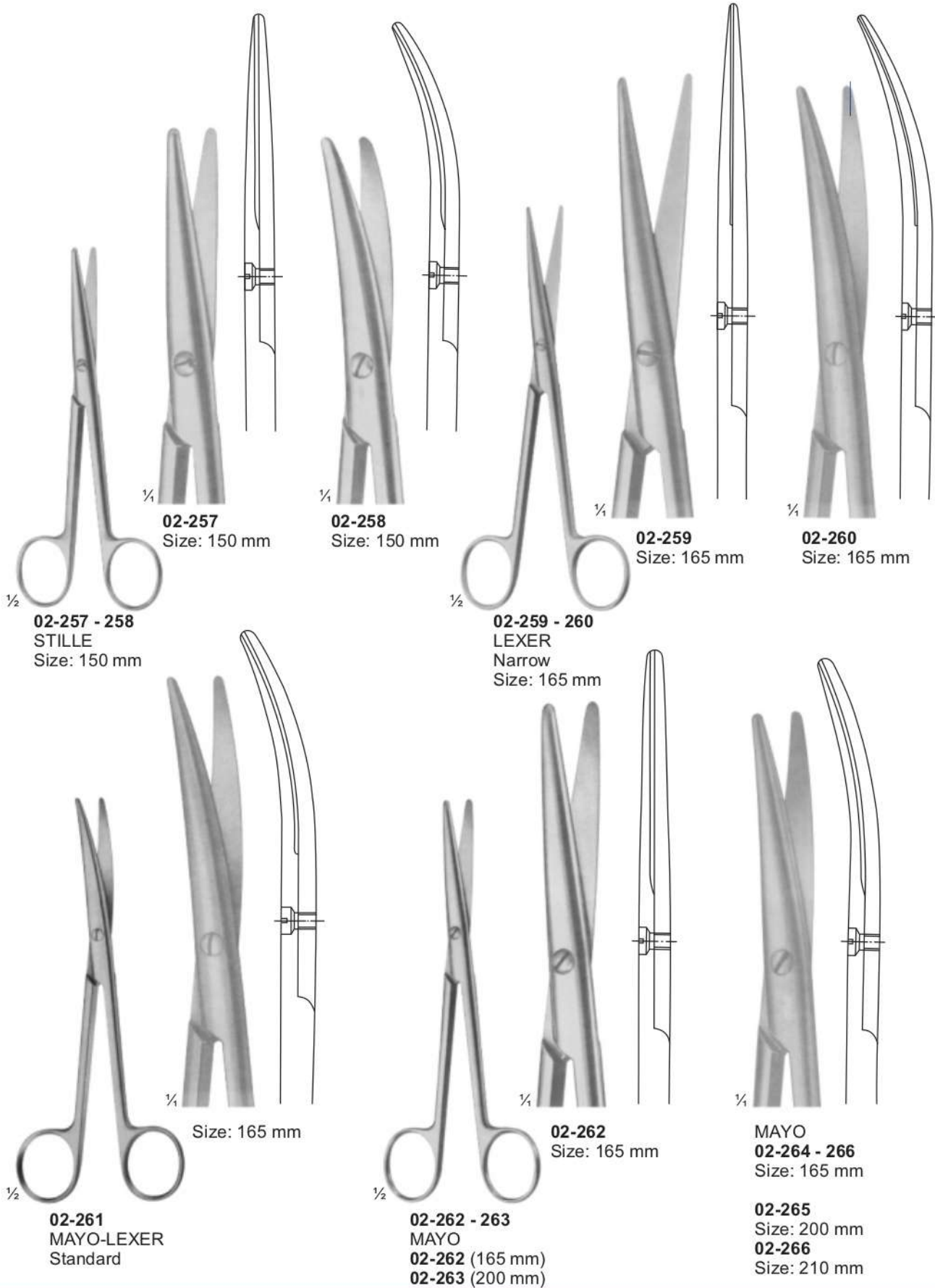

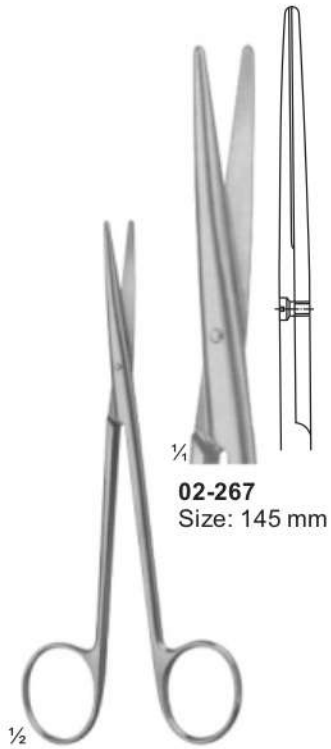

**02-267**  
Size: 145 mm



**02-268**  
Size: 145 mm

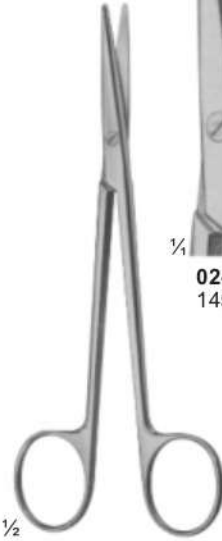

**02-269 - 274**  
METZENBAUM

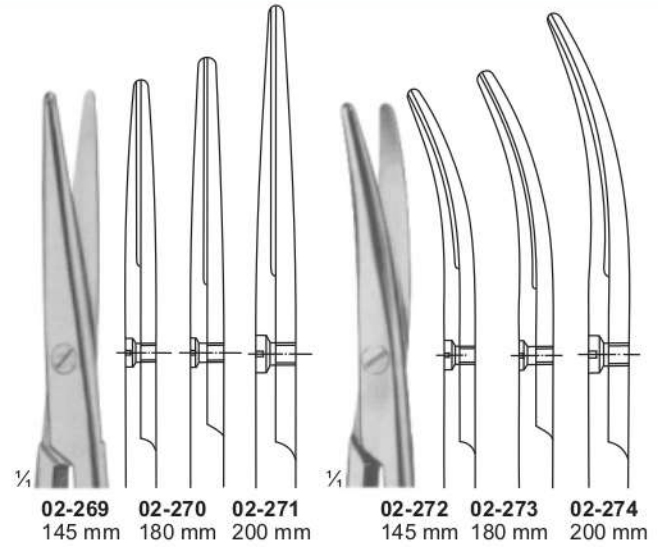

**02-269** 145 mm   **02-270** 180 mm   **02-271** 200 mm  
**02-272** 145 mm   **02-273** 180 mm   **02-274** 200 mm



**02-275 - 282**  
NELSON - METZENBAUM

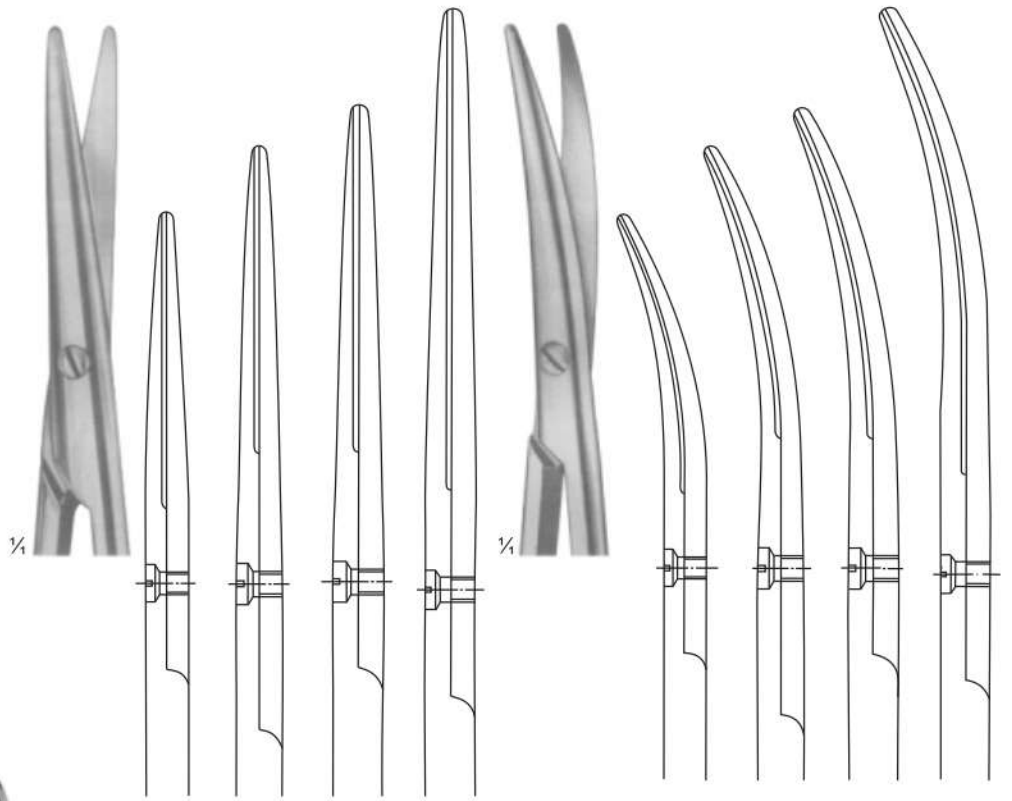

**02-275** 230 mm   **02-276** 250 mm   **02-277** 280 mm   **02-278** 305 mm  
**02-279** 230 mm   **02-280** 250 mm   **02-281** 280 mm   **02-282** 305 mm





**Vessel Scissors**  
Schiff Scaissors  
Scaissors Barco



**02-283 - 284**  
DE BAKHEY  
Size: 155 mm

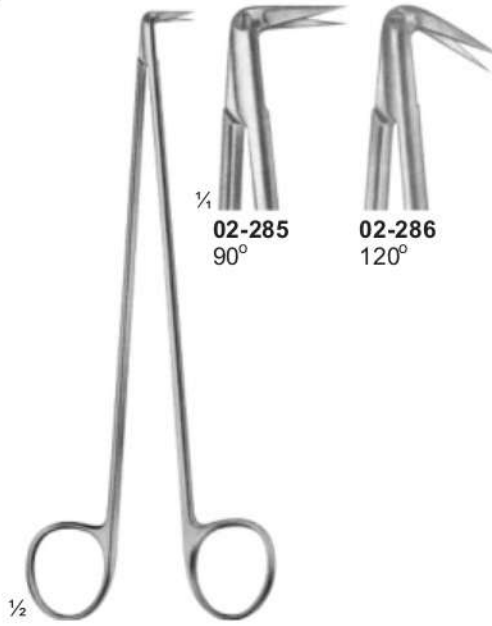

**02-285 - 286**  
DIETHRICH  
Size: 170 mm

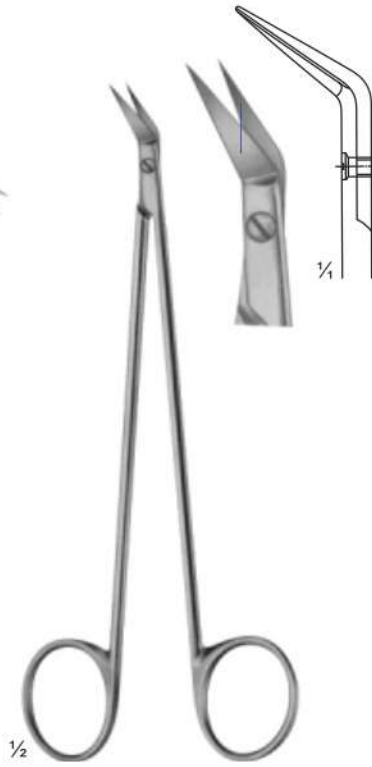

**02-287**  
POTTS-SMITH  
Size: 180 mm

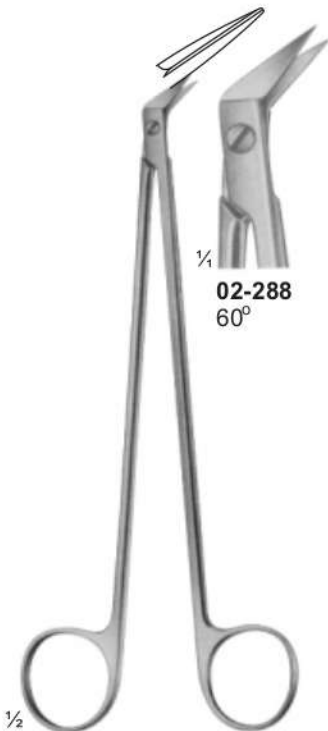

**02-288**  
POTTS-SMITH  
Size: 180 mm

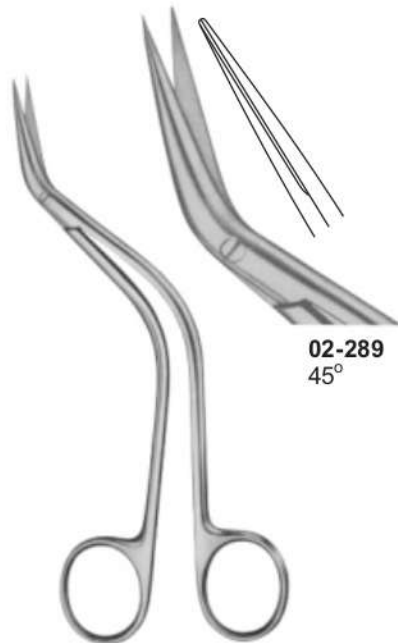

**02-289**  
DEBAKEY  
Size: 155 mm

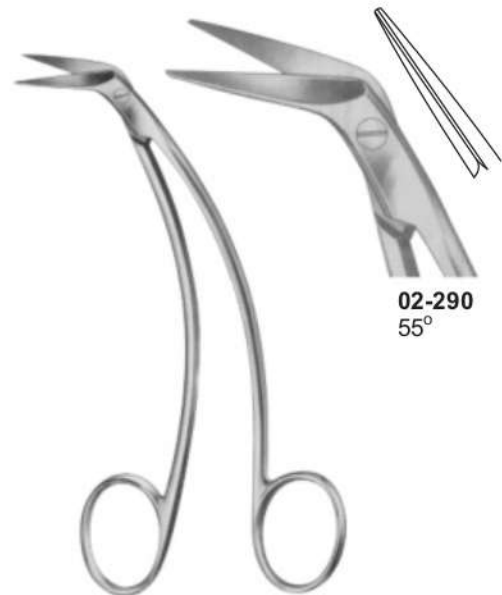

**02-290**  
FAVALORO  
Size: 140 mm



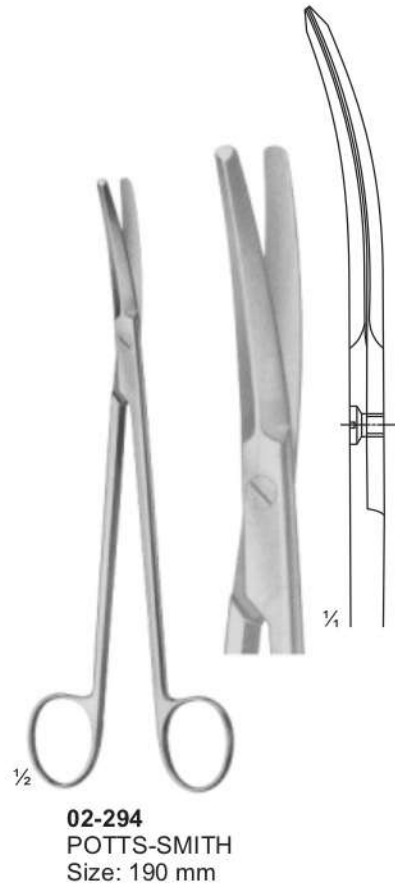
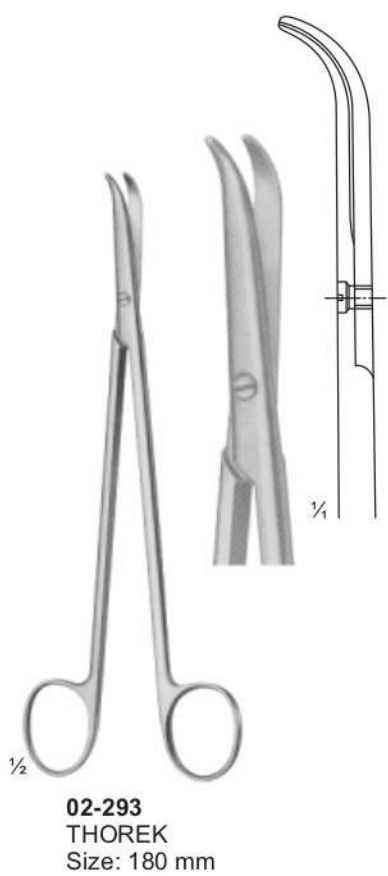
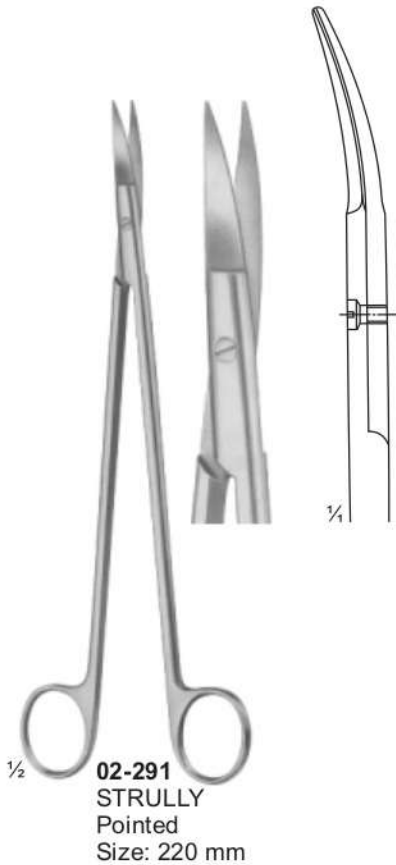

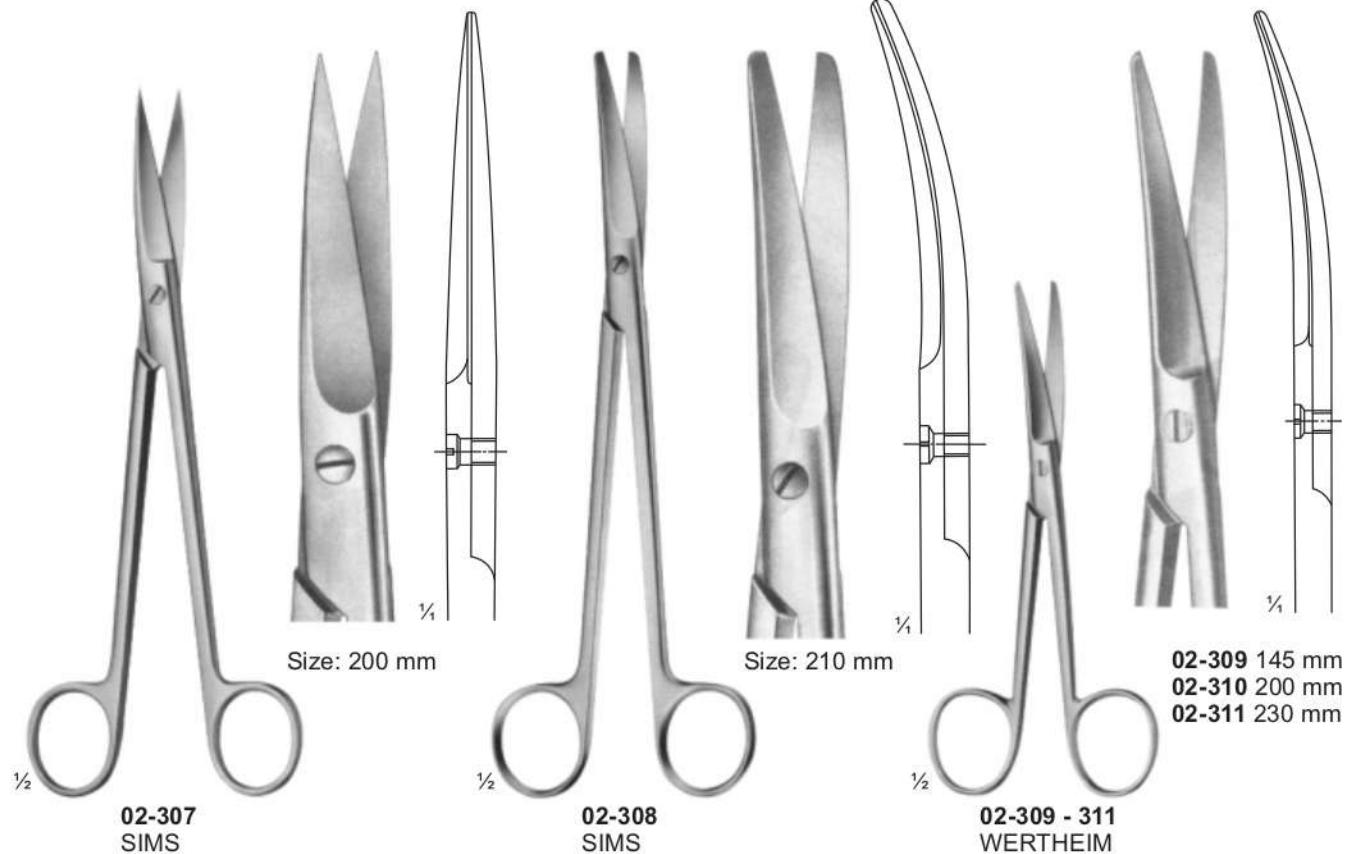
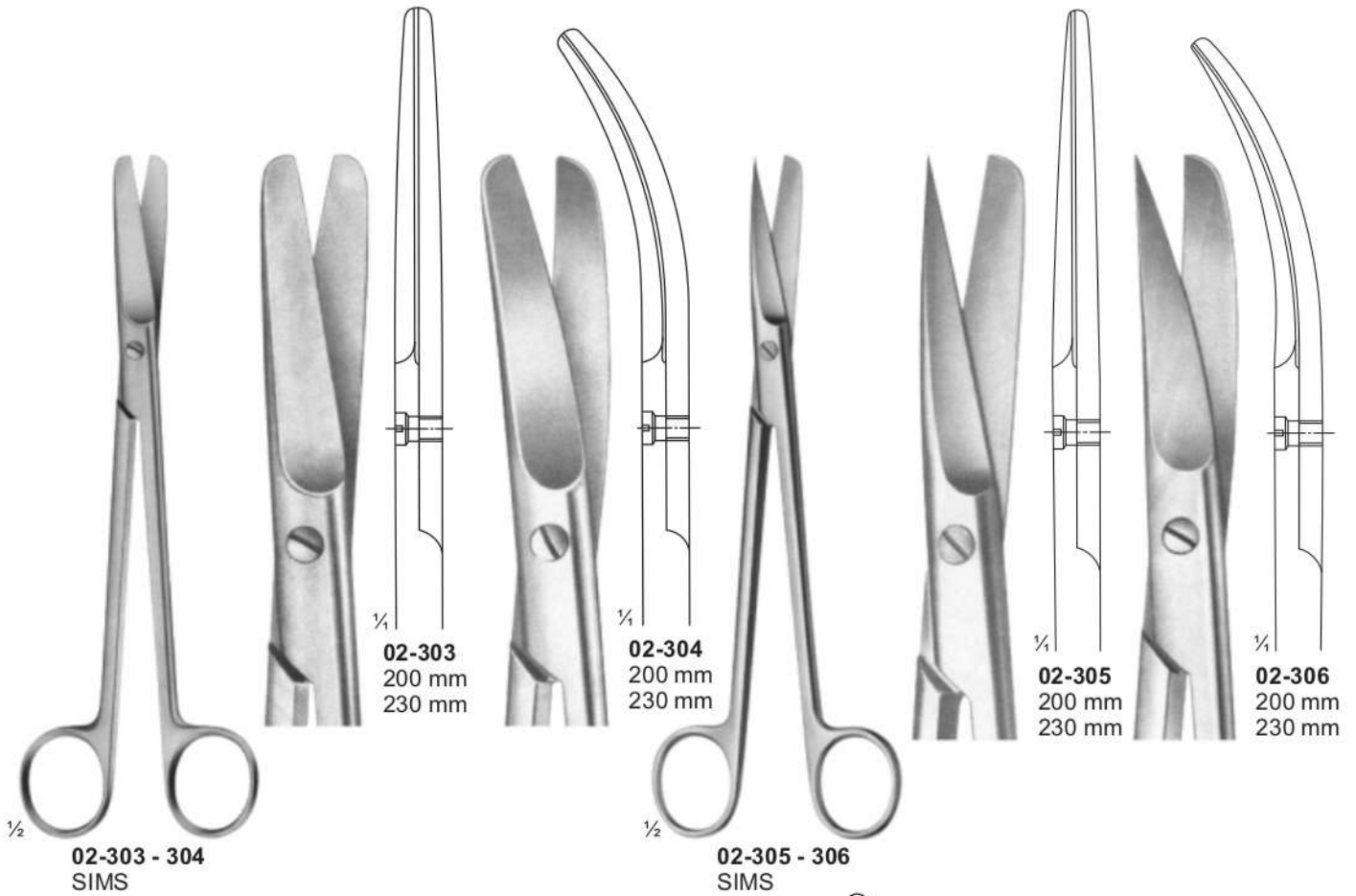



**Operating And Gynaecology Scissors**  
Betriebs-und Gynäkologie Schere  
Operativos Y Ginecología Tijeras

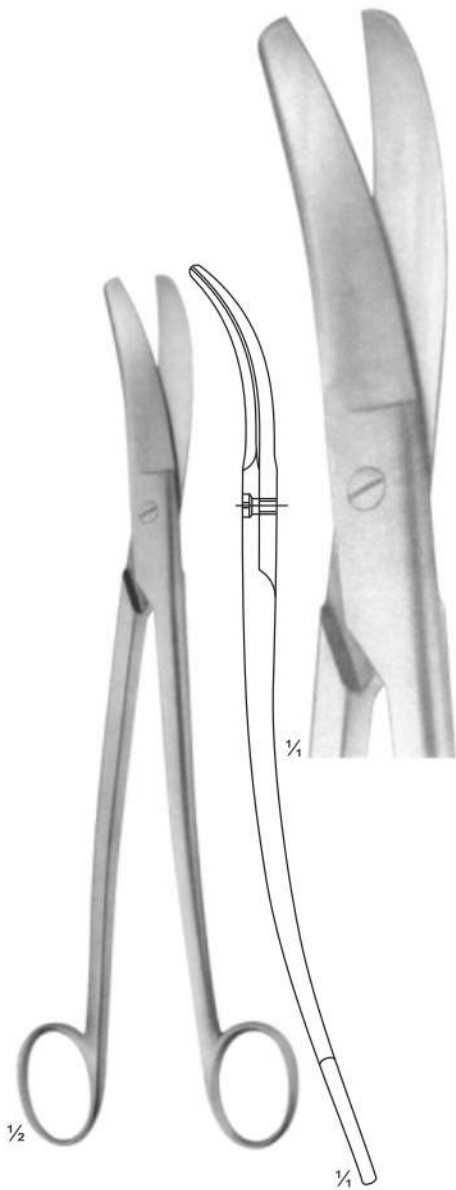

**02-312**  
SIEBOLD  
Uterine Scissors  
Size: 245 mm

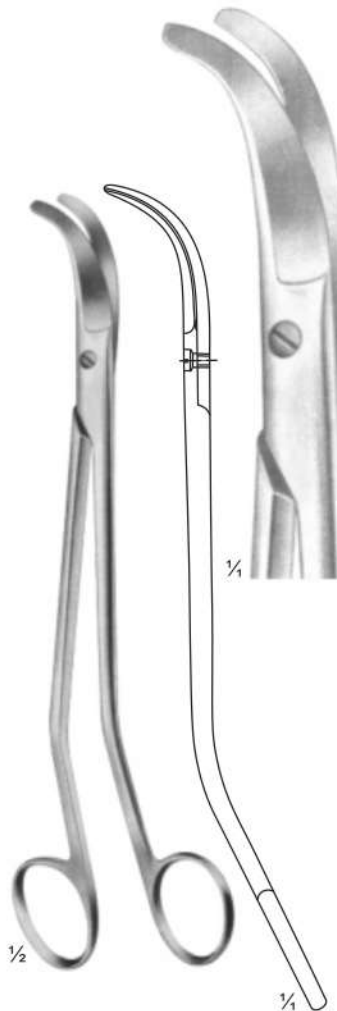

**02-313**  
BOZEMANN  
Uterine Scissors  
Size: 220 mm

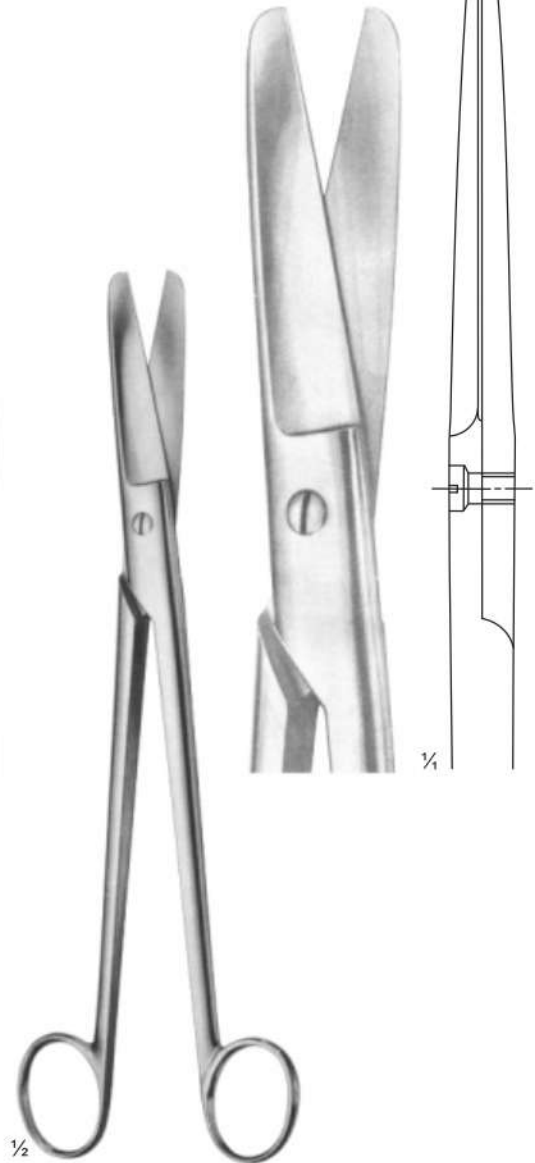

**02-314**  
SIMS-SIEBOLD  
Uterine Scissors  
Size: 250 mm



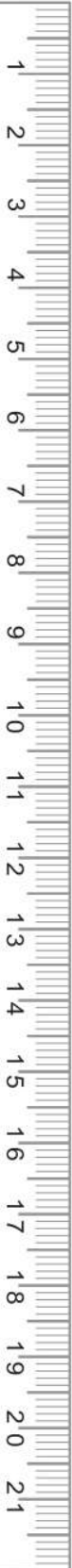

**02-315**  
SCHUMACHER  
Umbilical Cord Scissors  
Size: 155 mm



**02-316**  
Umbilical Cord Scissors  
Size: 105 mm

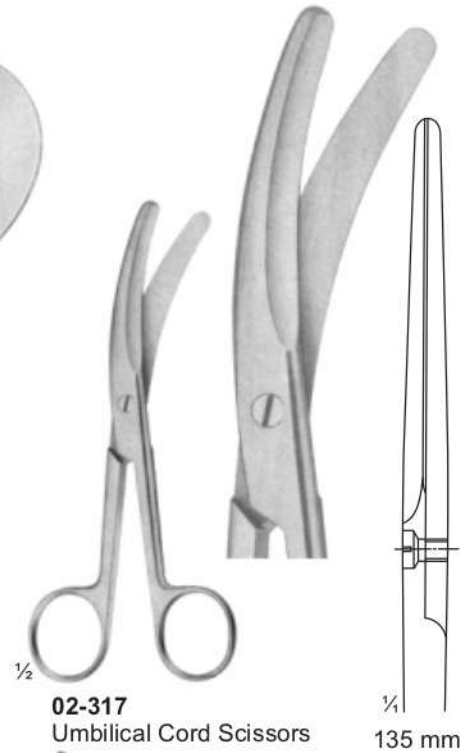

**02-317**  
Umbilical Cord Scissors

135 mm



**02-318 - 319**  
BRAUN-STADLER  
Empisiotomy Scissors

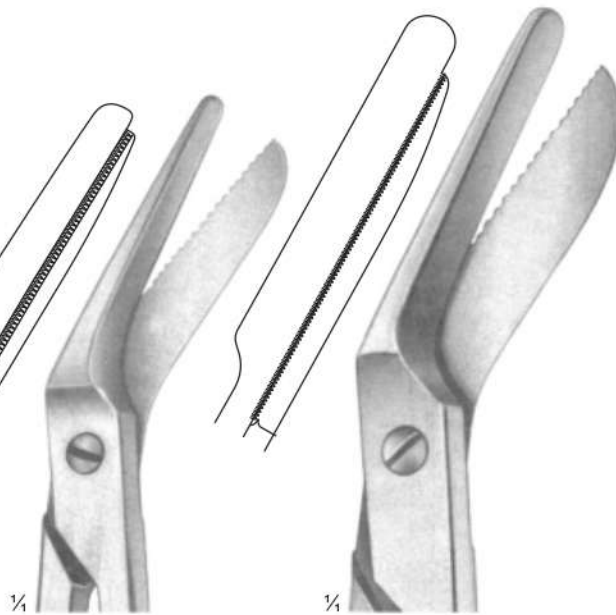

**02-318**  
145 mm

**02-319**  
200 mm

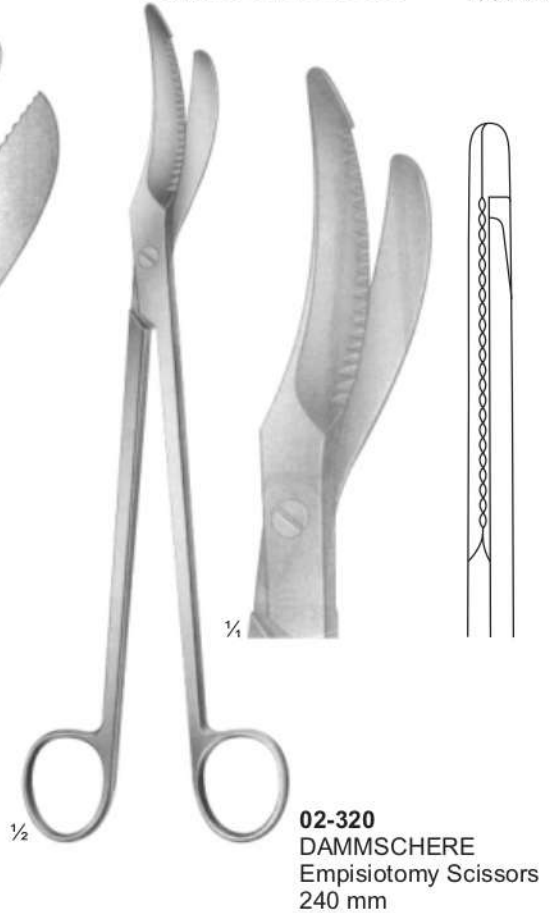

**02-320**  
DAMMSCHERE  
Empisiotomy Scissors  
240 mm



**Bowel Scissors, Cartilage Scissors**  
Darmschere, Knorpel-schere  
Tijeras, Tijeras Del Intestino Del Cartílago

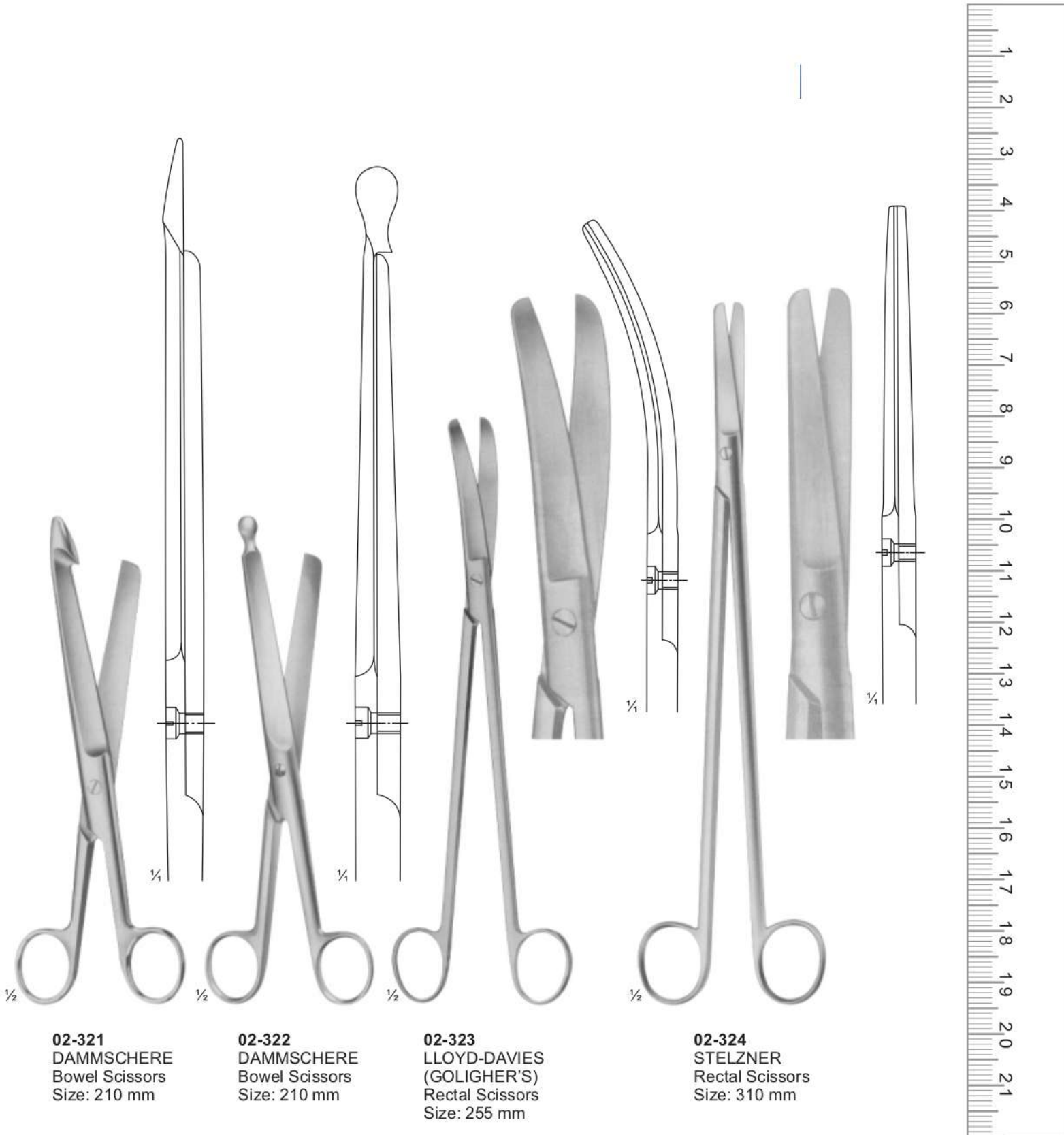

**02-321**  
DAMMSCHERE  
Bowel Scissors  
Size: 210 mm

**02-322**  
DAMMSCHERE  
Bowel Scissors  
Size: 210 mm

**02-323**  
LLOYD-DAVIES  
(GOLIGHER'S)  
Rectal Scissors  
Size: 255 mm

**02-324**  
STELZNER  
Rectal Scissors  
Size: 310 mm

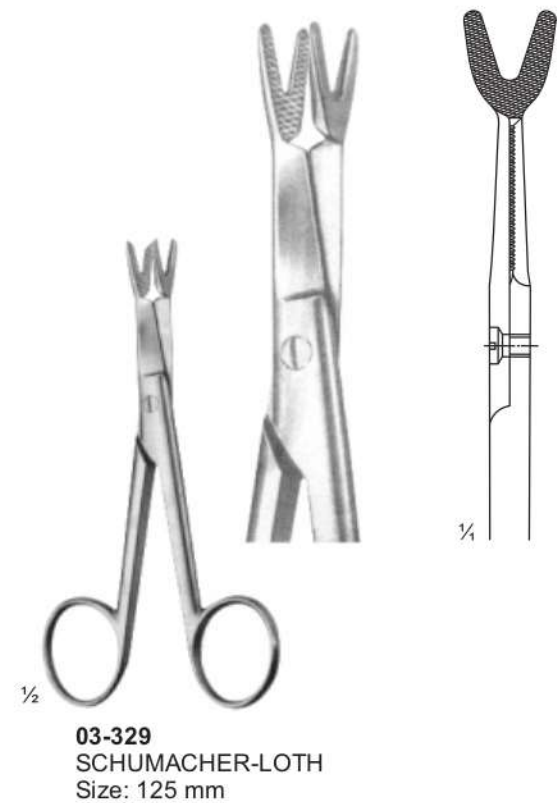
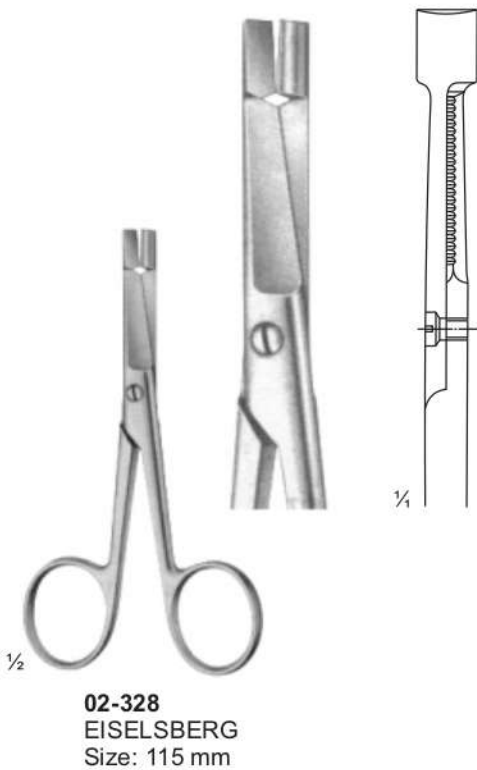
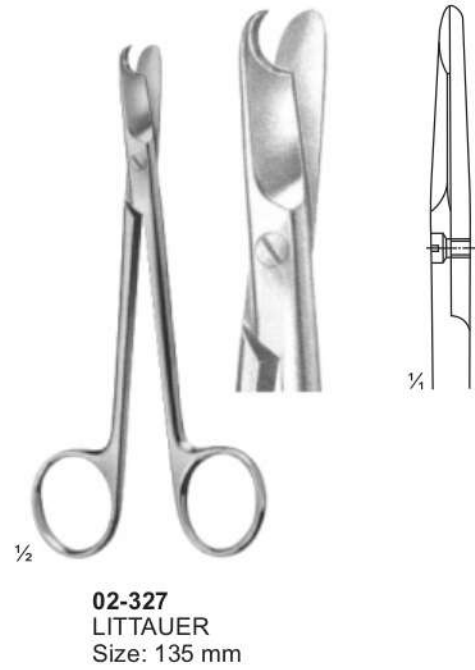
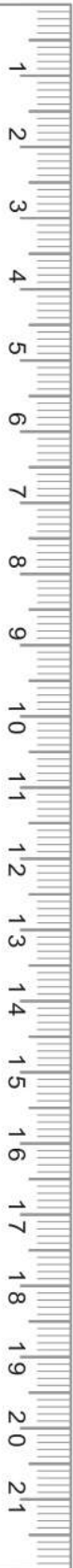

**Wire And Plate Scissors**  
**Drähten Und Platten Schere**  
**De Alambre Y La Placa De Tijeras**



**MATU BROTHERS  
 SURGICAL**



**02-330-334**  
**BEEBE**  
 Size: 110 mm

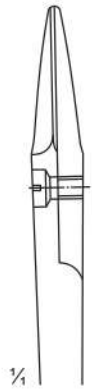

**02-330**

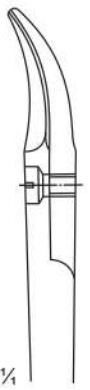

**02-331**

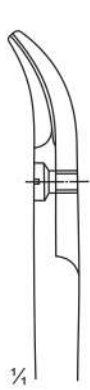

**02-332**  
 Broad Blades

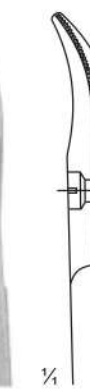

**02-333**  
 1 Blade Serrated

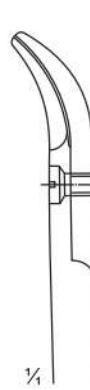

**02-334**  
 NAUJOKS  
 Strongly Curved

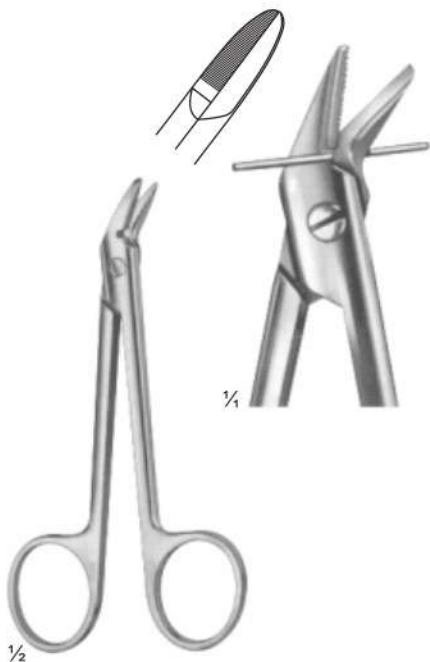

**02-335**  
 1 Blade Serrated  
 Size: 120 mm



1/2

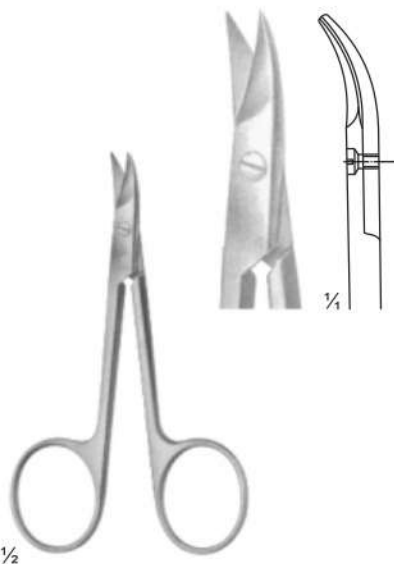

**02-336**  
 STRACK  
 Size: 100 mm

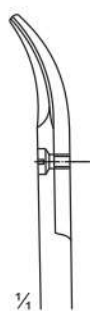

1/2

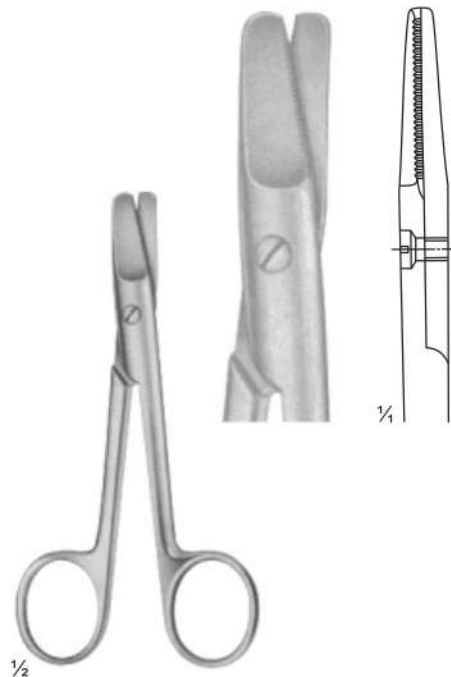

**02-337**  
 HARVEY  
 Size: 125 mm

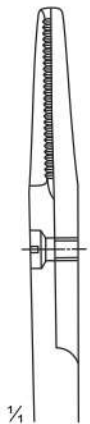

1/2





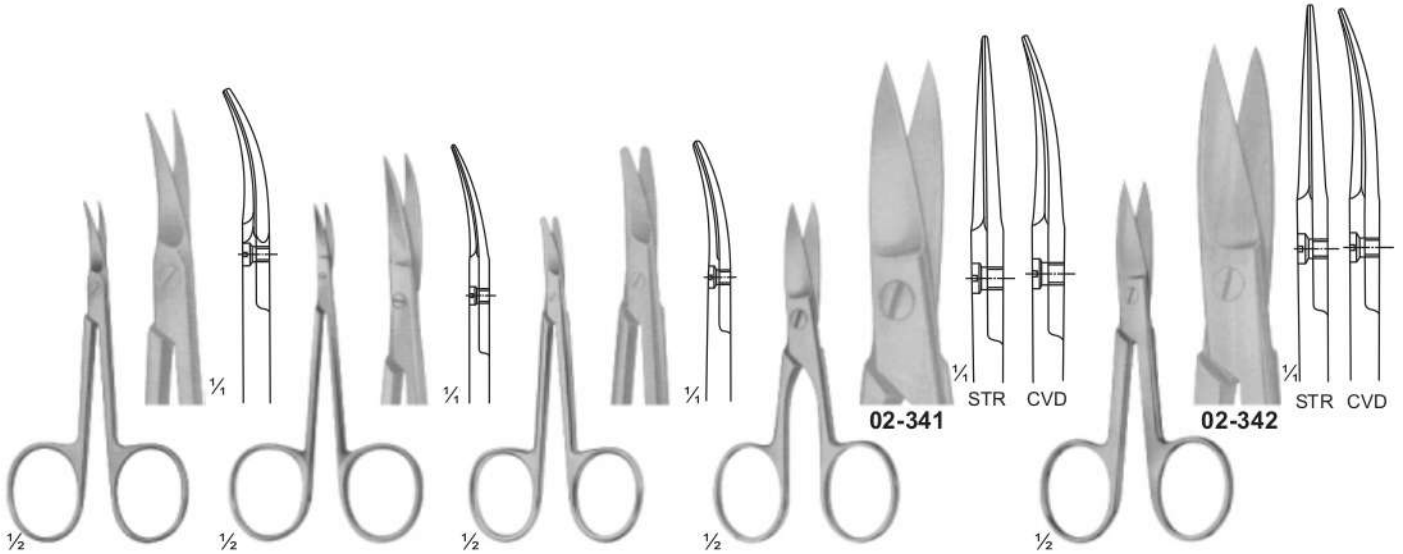
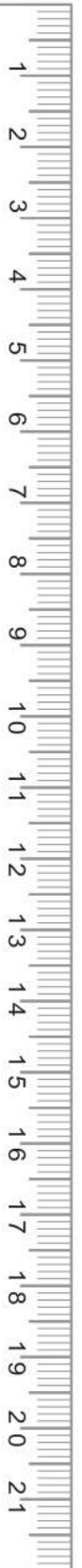

**02-338**  
**NAIL SCISSORS**  
 Size: 90 mm

**02-339**  
**NAIL SCISSORS**  
 Size: 90 mm

**02-340**  
**BABY NAIL SCISSORS**  
 Size: 85 mm

**02-341**  
**NAIL SCISSORS**  
 Size: 90 mm

**02-342**  
**NAIL SCISSORS**  
 Size: 90 mm



**02-343**  
**KNOWLES**  
 Size: 140 mm

**02-344**  
**KNOWLES**  
 Size: 145 mm

**02-345**  
**SMITH**  
 Size: 150 mm

**02-346**  
**SMITH US**  
 Size: 180 mm

**02-347**  
**TAILOR**  
 Size: 310 mm

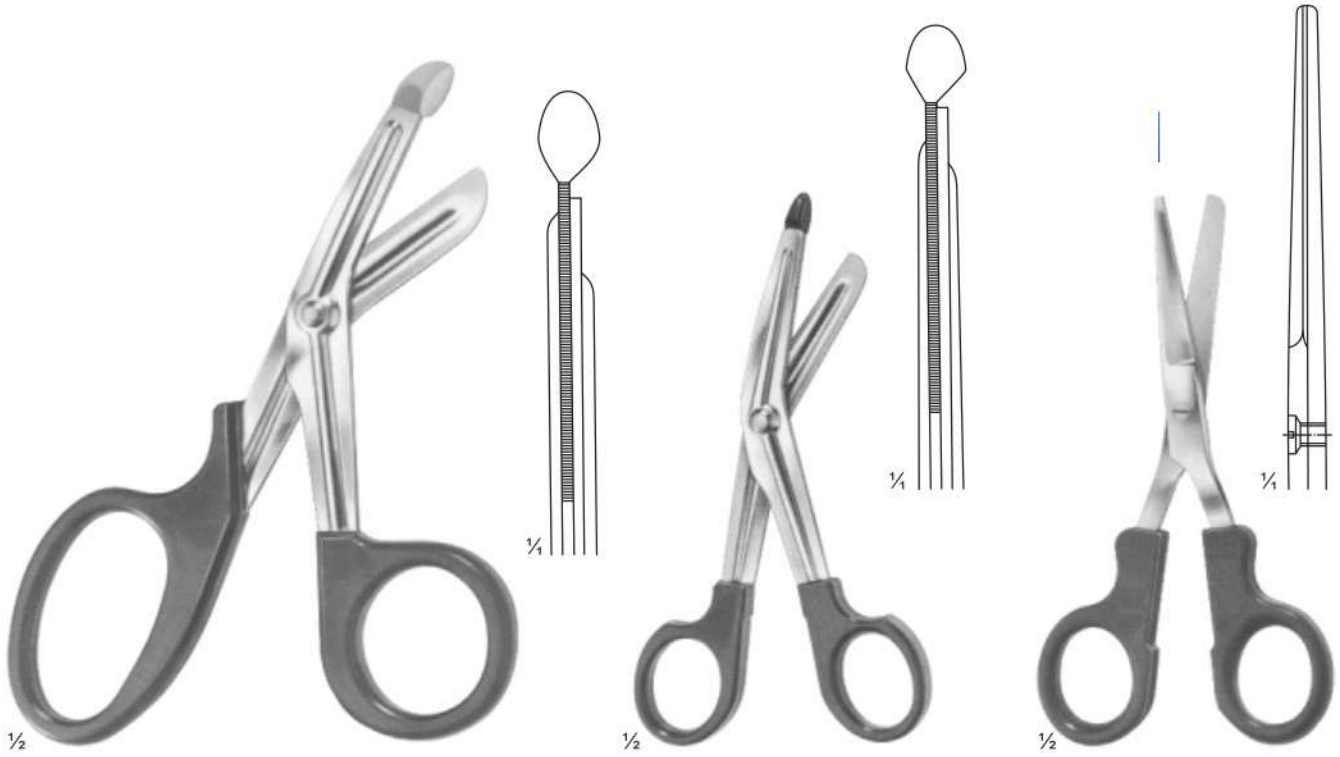

**02-348**  
**UNIVERSAL BANDAGE SCISSORS**  
 180 mm

**02-349**  
**LISTER**  
 Size: 145 mm

**02-350**  
**LISTER**  
 Size: 145 mm

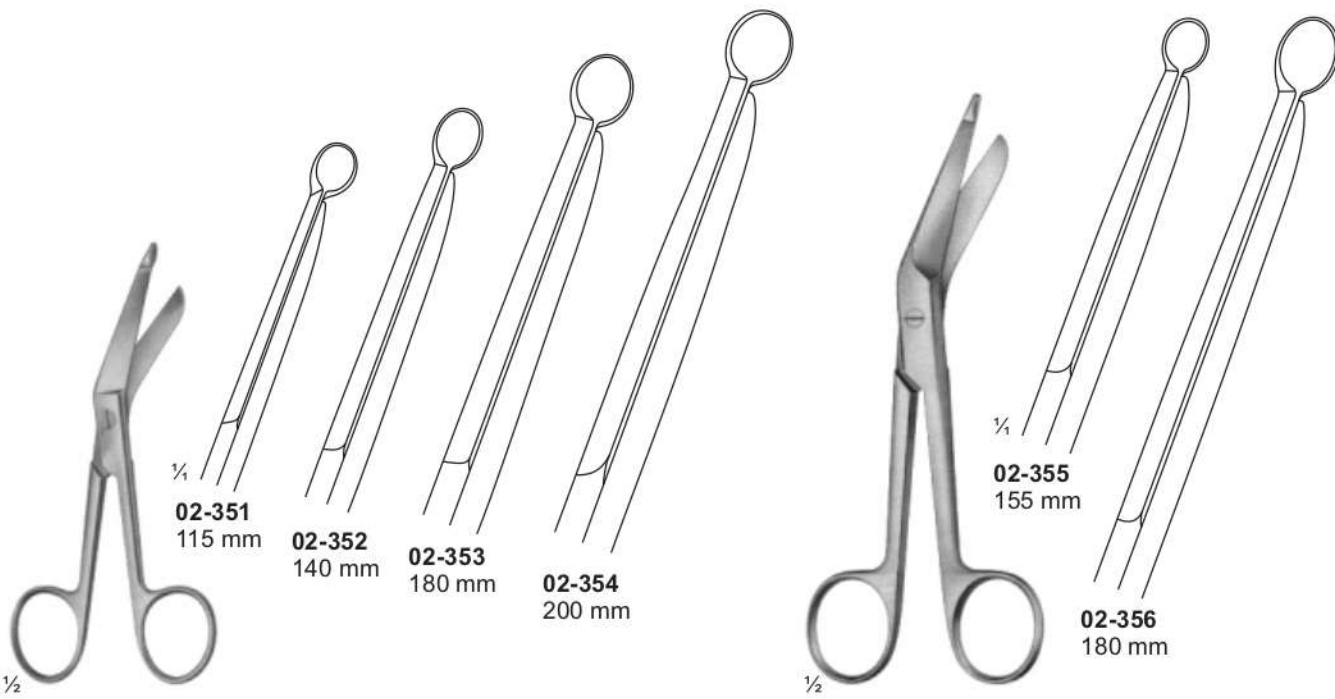

**02-351 - 354**  
**LISTER**

**02-355 - 356**  
**LISTER**

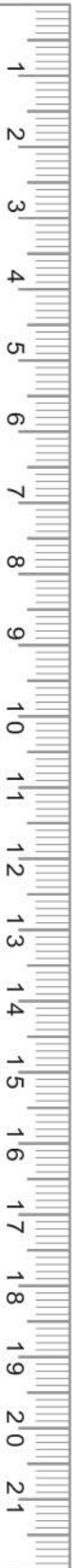

**02-357**  
PLASTER CUTTING  
SCISSORS  
205 mm

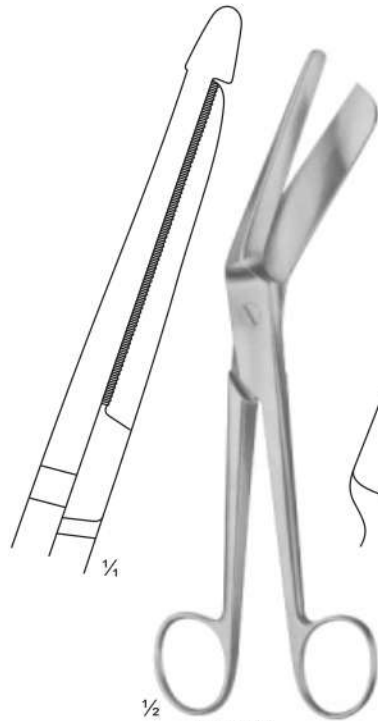

**02-358**  
BRAUN-STADLER  
225 mm



**02-359**  
SEUTIN  
230 mm

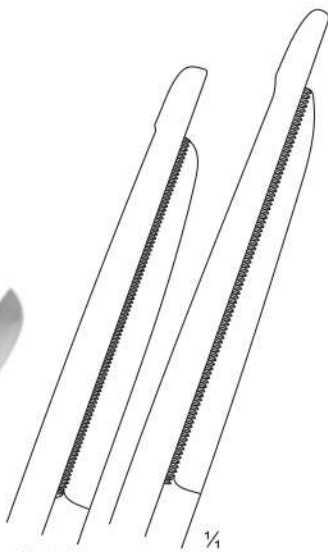

**02-360** 200 mm

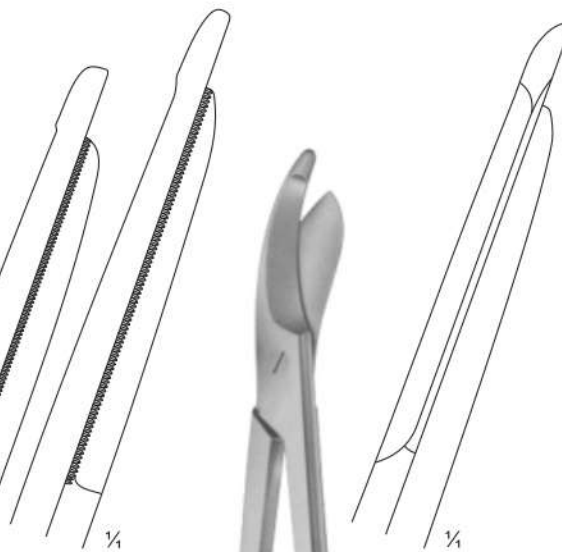

**02-361** 230 mm



**02-360 - 361**  
ESMARCH



**02-362**  
BRUNS  
235 mm

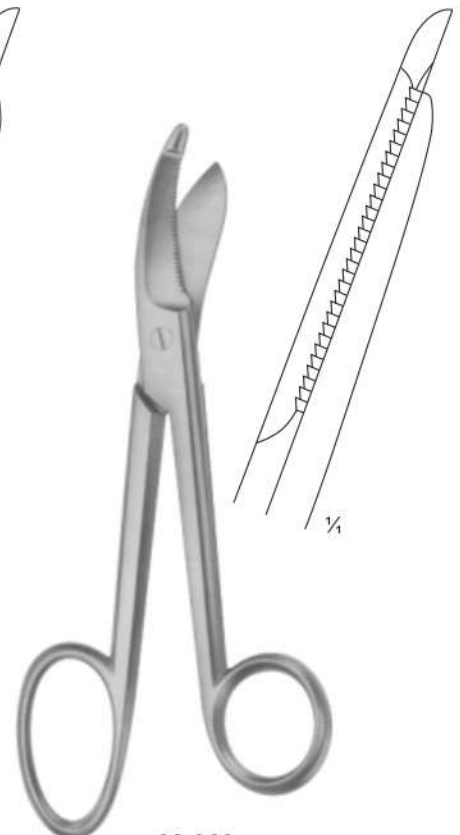

**02-363**  
BRUNS  
235 mm



Micro Forceps, Jeweler Types  
Mikropinzette, Juwelier-typen  
Pinza Micro, Tipos Joyero

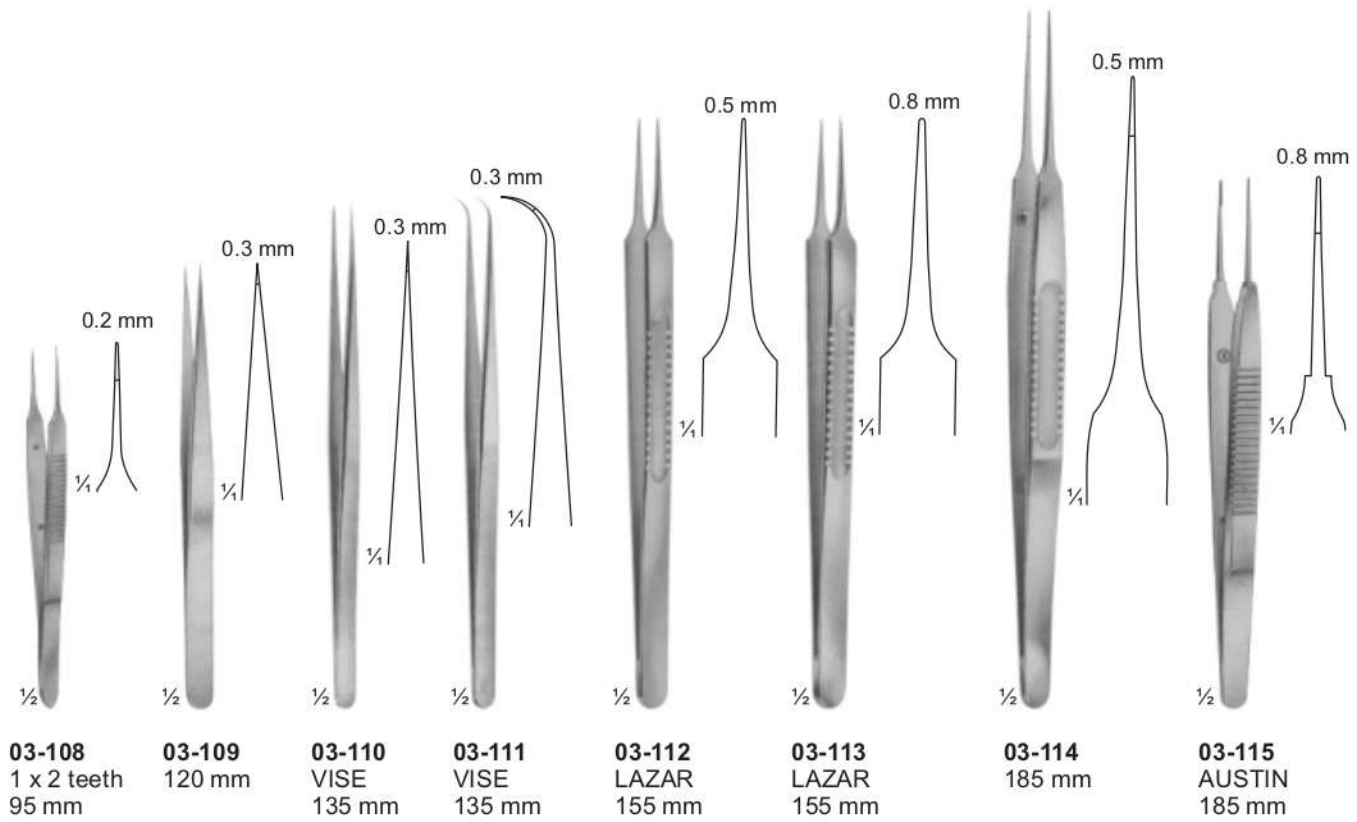
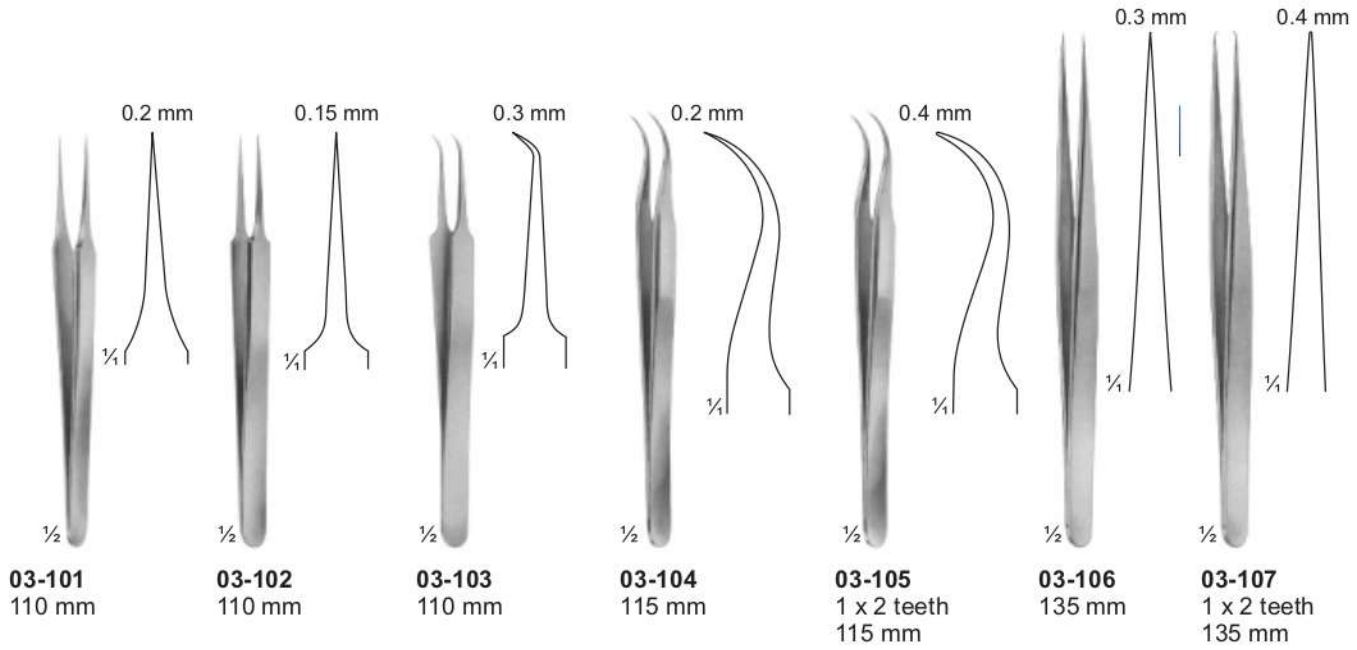

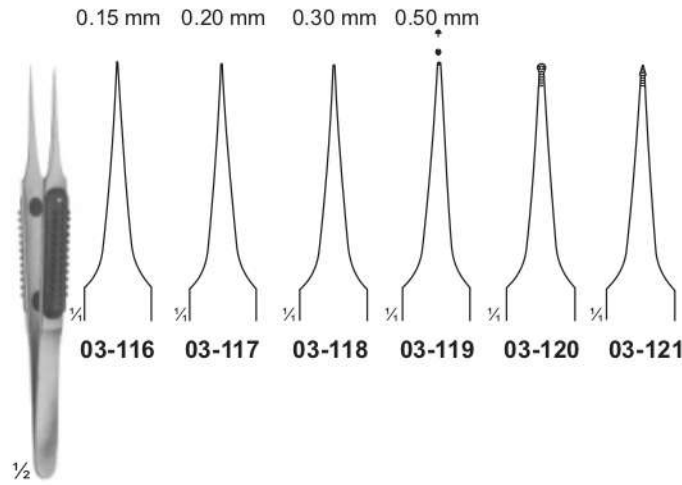
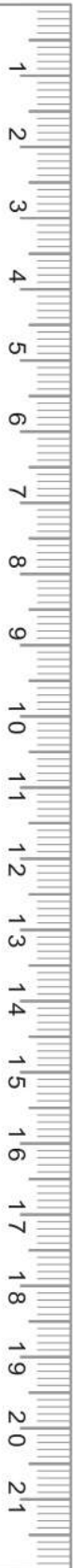

**03-116 - 121**  
**MULLER**  
 110 mm

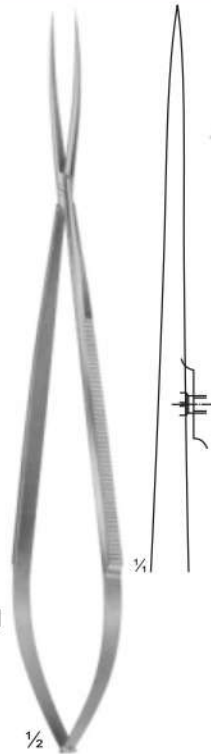

**03-122**  
**LIGATURE FORCEPS**  
 220 mm

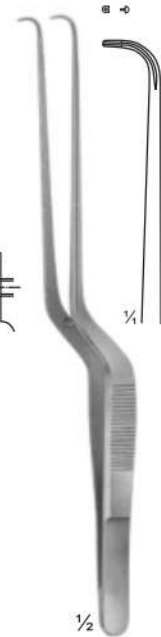

**03-123**  
**YASARGIL**  
 185 mm

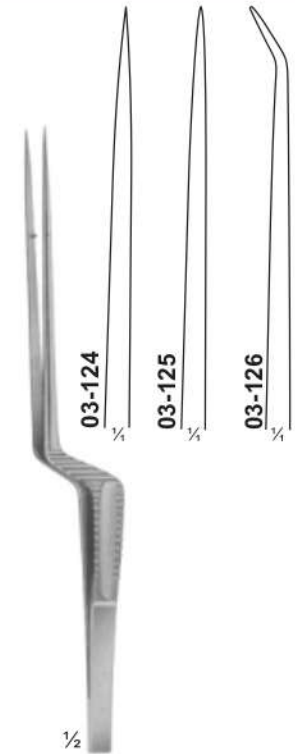

**03-124 - 126**  
**MICRO FORCEPS**  
 185 mm

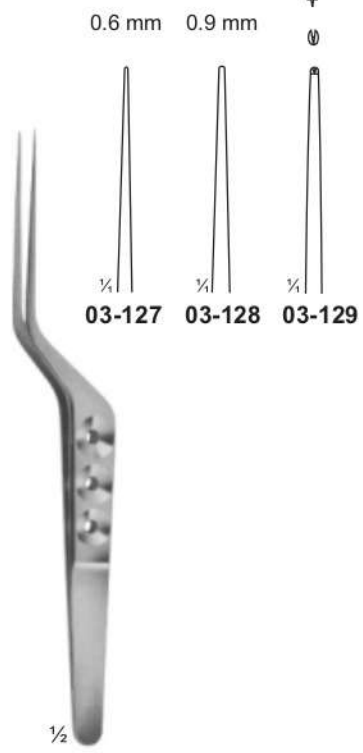

**03-127 - 129**  
**YASARGIL**  
 180 mm

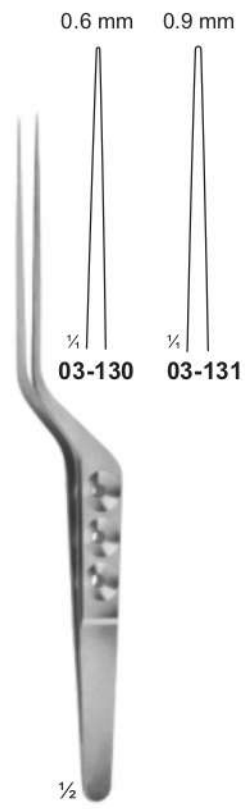

**03-130 - 131**  
**YASARGIL**  
 200 mm



**03-132 - 133**  
**YASARGIL**  
 220 mm



**03-134 - 135**  
**YASARGIL**  
 240 mm

**Forceps For Grasping Tissue, Tumors**  
**Pinzette Zum Fassen Von Gewebe, Tumore**  
**Pinzas Para Sujetar Tejidos, Los Tumores**



**MATU BROTHERS  
SURGICAL**

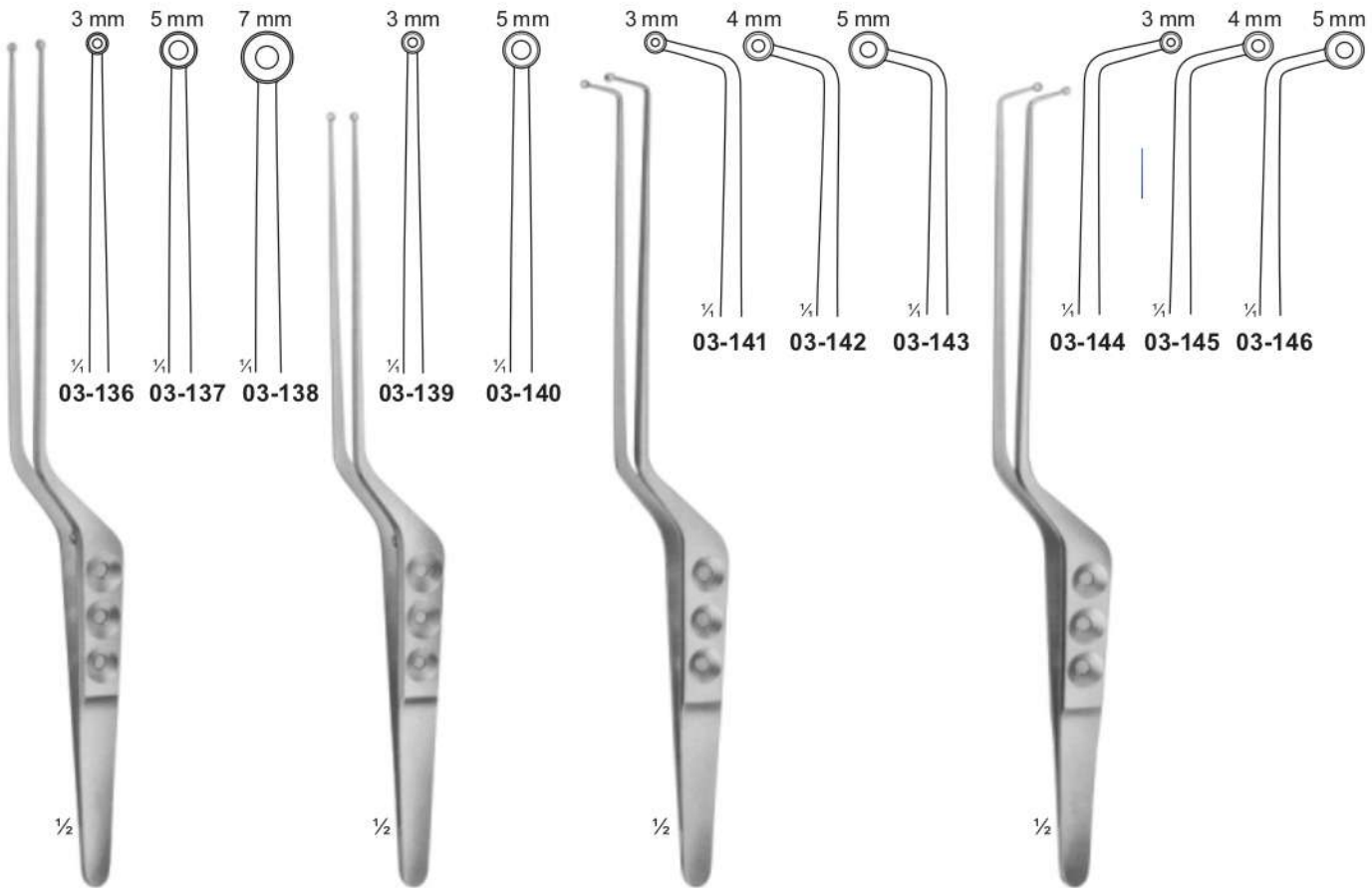

**03-136 - 138**  
**YASARGIL-SAMI**  
 Jaws Spoon-Shaped  
 240 mm

**03-139 - 140**  
**YASARGIL**  
 Jaws Spoon-Shaped  
 220 mm

**03-141 - 143**  
**SAMII**  
 Jaws Spoon-Shaped  
 230 mm

**03-144 - 146**  
**SAMII**  
 Jaws Spoon-Shaped  
 230 mm

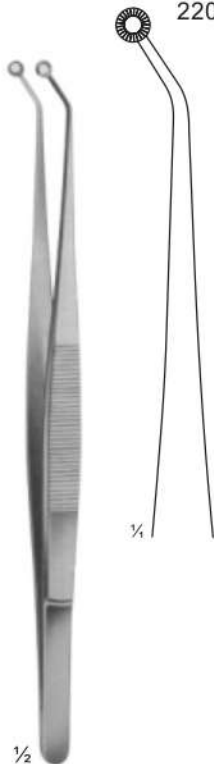

**03-147**  
**HUNT** 1/2  
 Tumor-and Vessel Forceps  
 200 mm



**03-148**  
**HUNT** 1/2  
 Tumor-and Vessel Forceps  
 200 mm



**03-149**  
**YASARGIL** 1/2  
 Tumor-and Vessel Forceps  
 200 mm



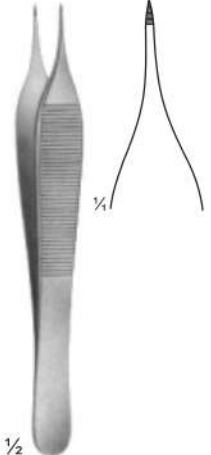
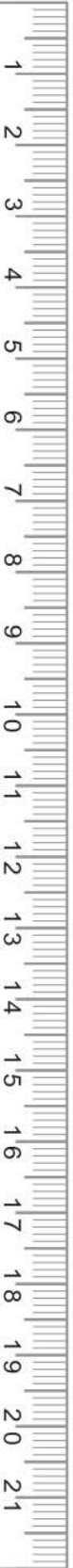

**03-150**  
THORPE  
Corneal Forceps  
120 mm

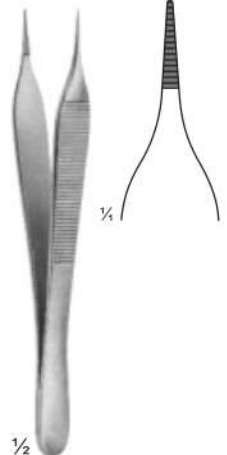

**03-151**  
MICRO-ADSON  
120 mm

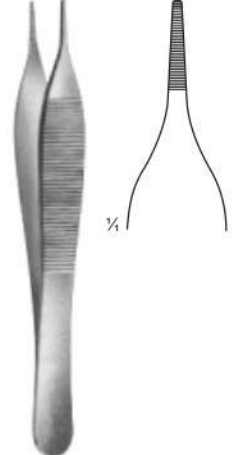

**03-152**  
ADSON  
120 mm

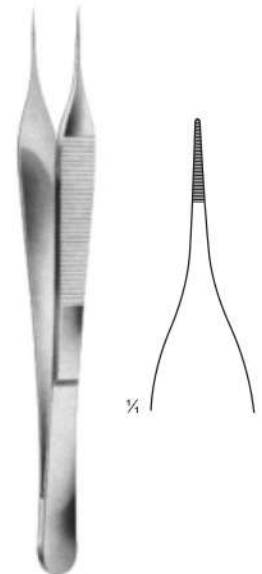

**03-153**  
MICRO-ADSON  
150 mm

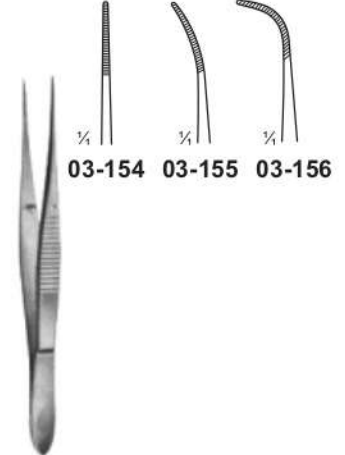

**03-154 - 156**  
100 mm

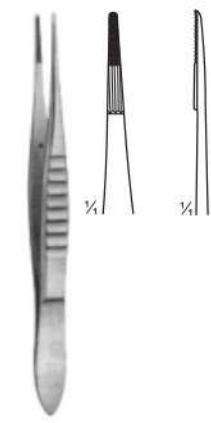

**03-157**  
110 mm

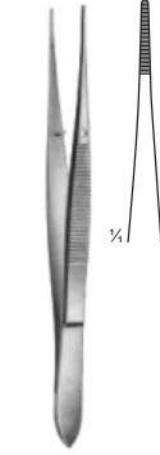

**03-158**  
115 mm



**03-159 - 168**

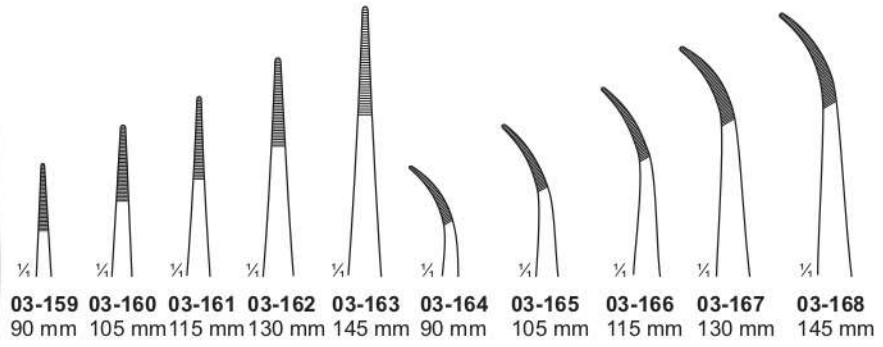

**03-159** 90 mm **03-160** 105 mm **03-161** 115 mm **03-162** 130 mm **03-163** 145 mm **03-164** 90 mm **03-165** 105 mm **03-166** 115 mm **03-167** 130 mm **03-168** 145 mm



**03-169**  
100 mm

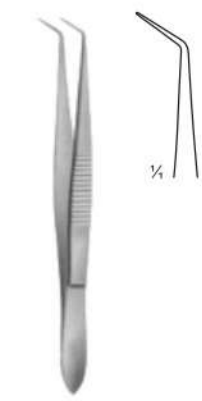

**03-170**  
100 mm

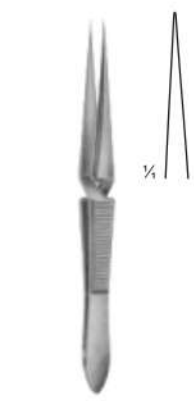

**03-171**  
100 mm

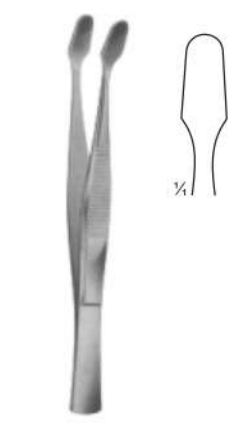

**03-172**  
COVER GLASS FORCEPS  
105 mm



**03-173**  
160 mm



**Delicate Dissecting Forceps**  
Zarte Dissektionszangen  
Delicadas Pinza De Disección

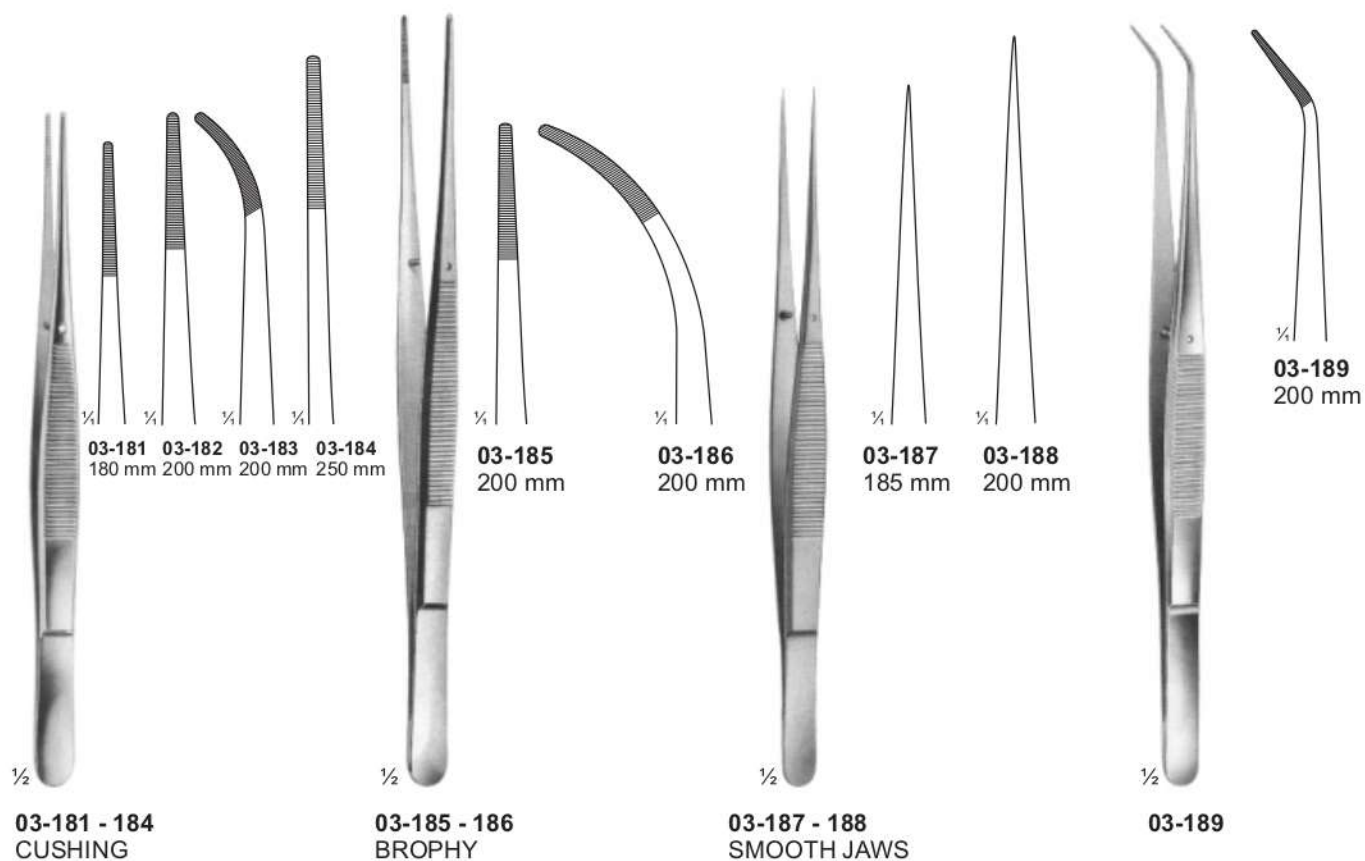
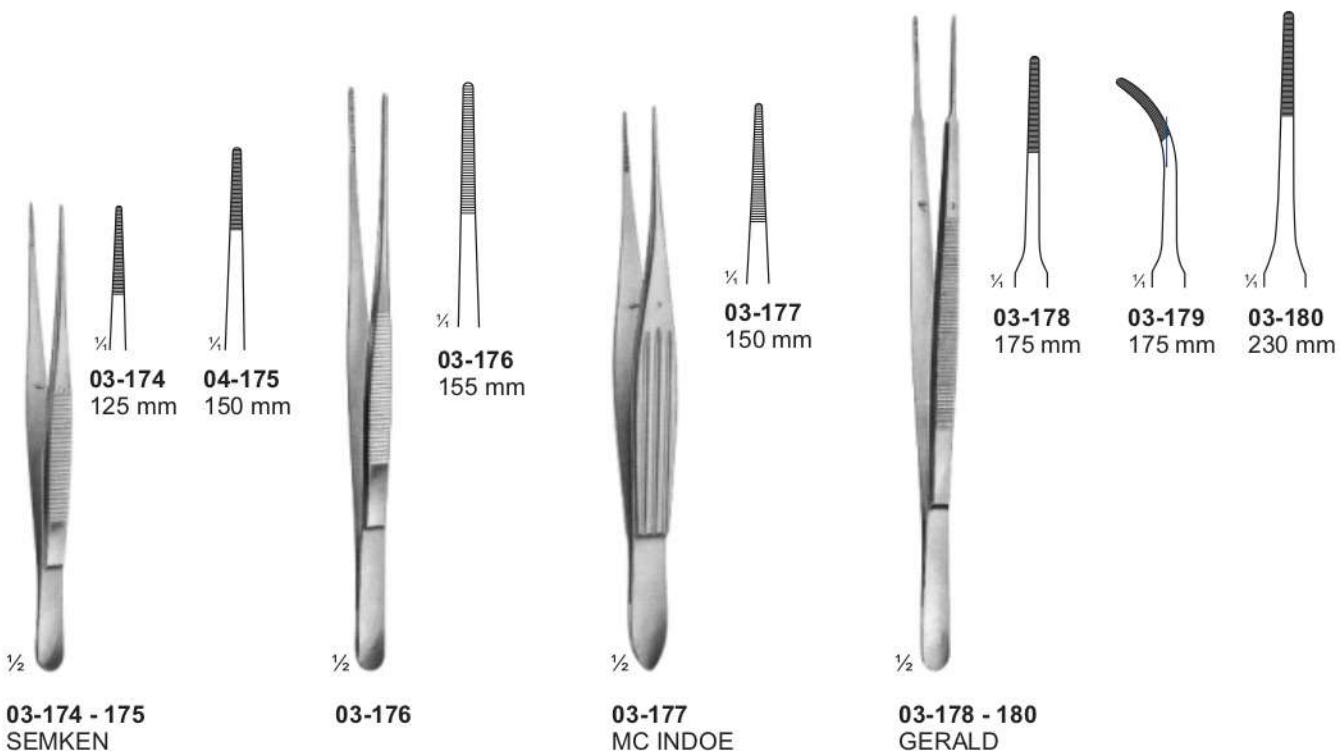



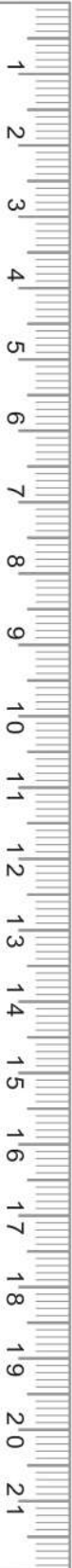

03-190 - 197  
STANDARD



03-190  
115 mm



03-191  
130 mm



03-192  
145 mm



03-193  
160 mm



03-194  
180 mm



03-195  
200 mm



03-196  
250 mm



03-197  
300 mm



03-198 - 202  
MEDIUM



03-198  
115 mm



03-199  
130 mm



03-200  
145 mm



03-201  
160 mm



03-202  
305 mm



03-203 - 204  
MEDIUM



03-203  
130 mm



03-204  
145 mm

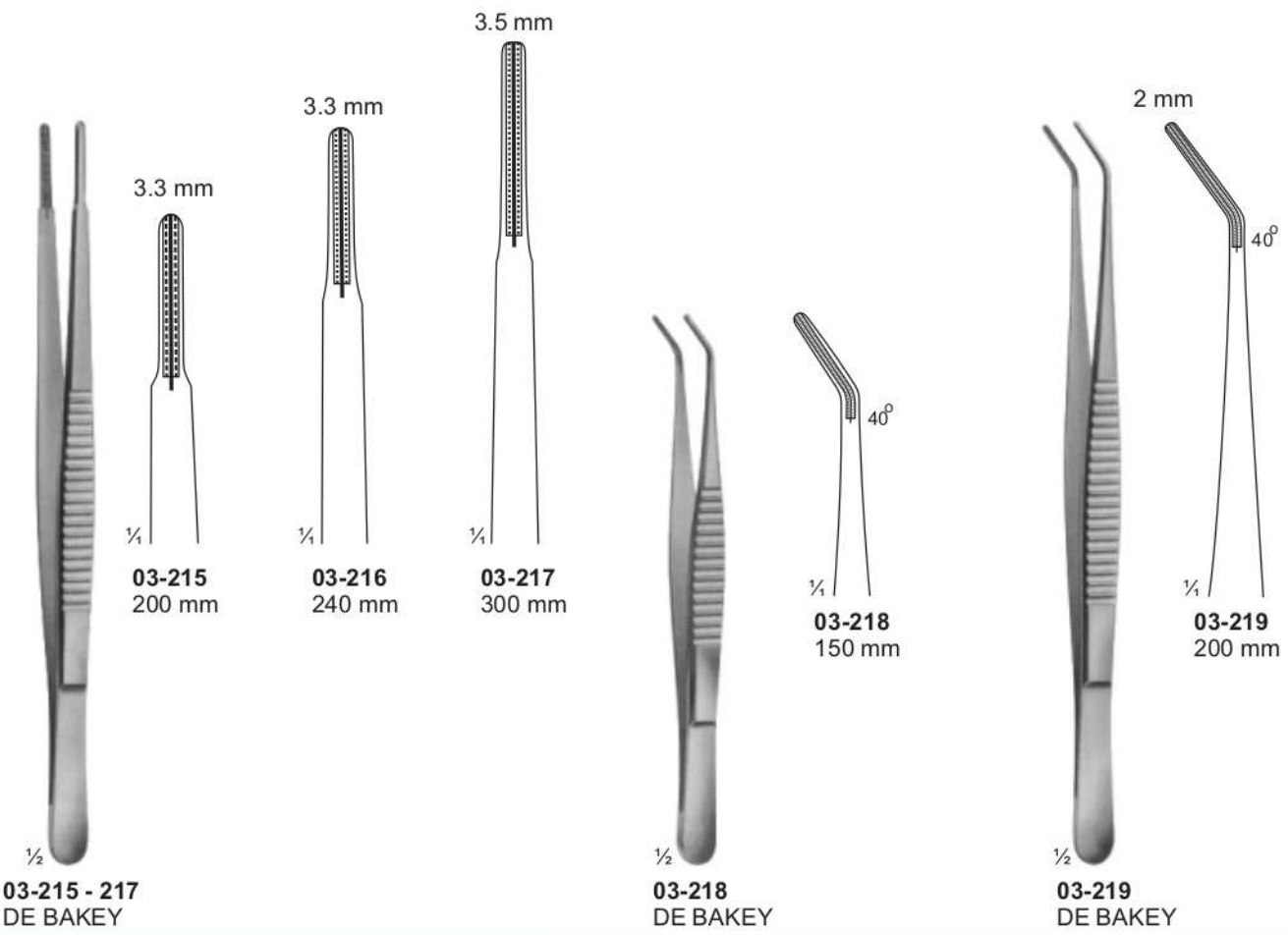
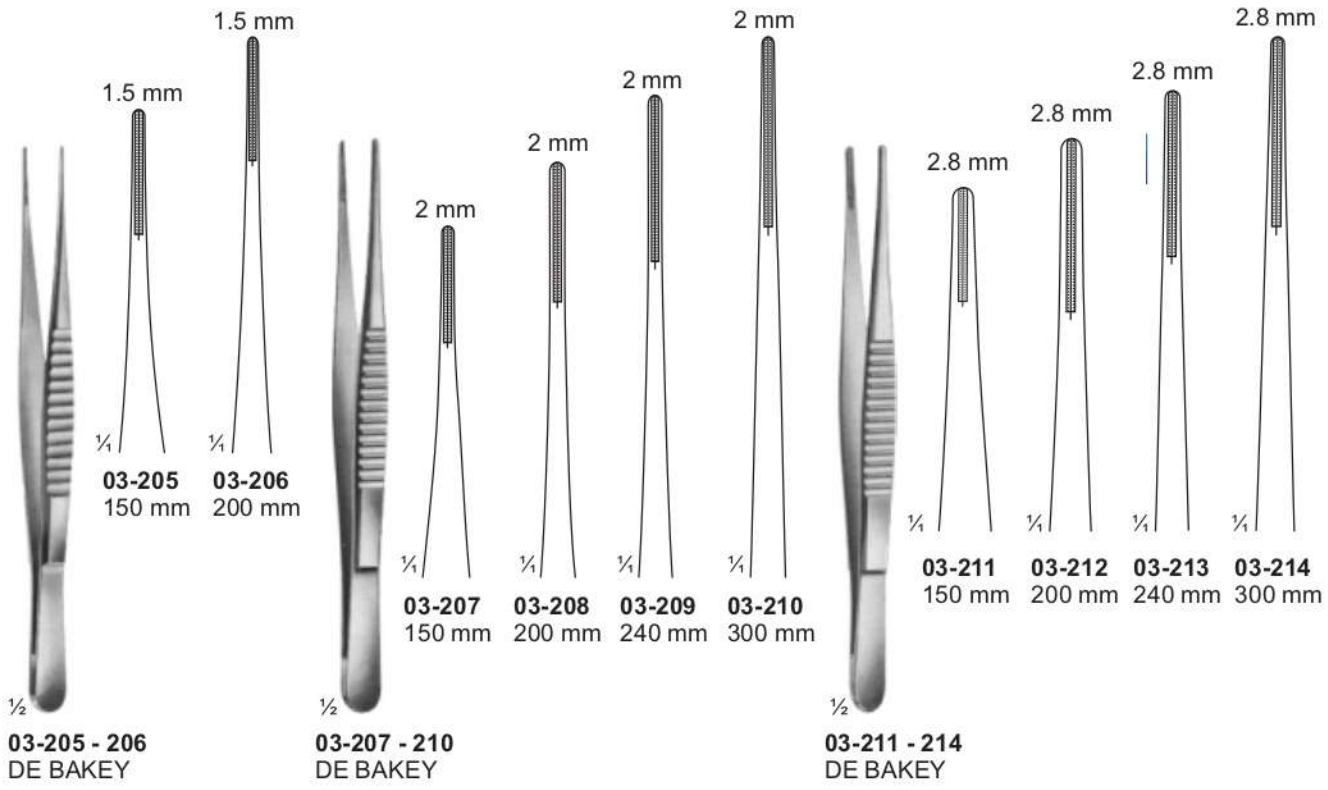



Delicate Tissue Forceps  
Zarte Pinzette  
Pinzas De Tejidos Delicados

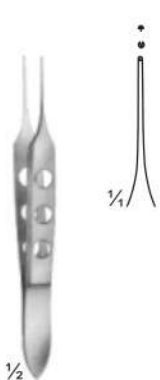

03-232  
BISHOP-HARMON  
85 mm

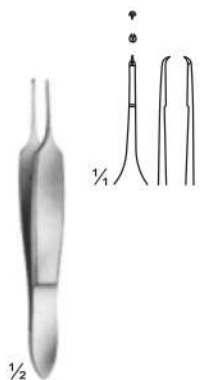

03-233  
ST.MARTIN  
80 mm

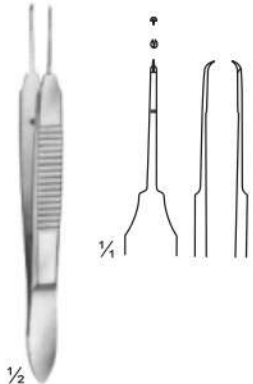

03-234  
CASTROVIEJO  
teeth 0.9 mm  
100 mm

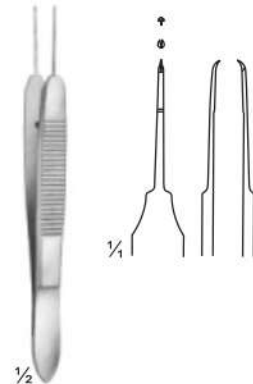

03-235  
CASTROVIEJO  
teeth 0.5 mm  
100 mm

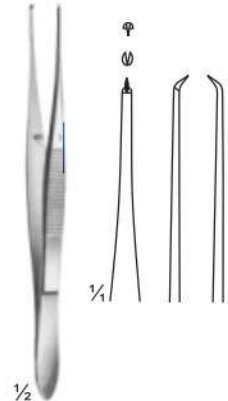

03-236  
ELSCHING  
110 mm



03-237  
GILL  
75 mm



03-238  
GILL - HESS  
75 mm

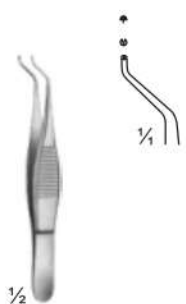

03-239  
HESS  
70 mm

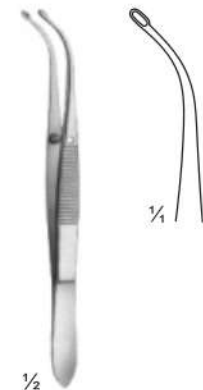

03-240  
ARRUGA  
100 mm

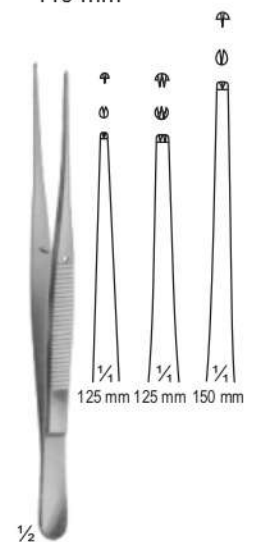

03-241  
SEMKEN  
125 mm 125 mm 150 mm

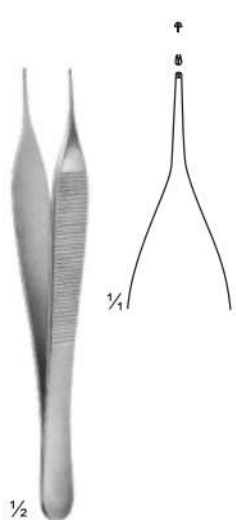

03-242  
MICRO-ADSON  
120 mm

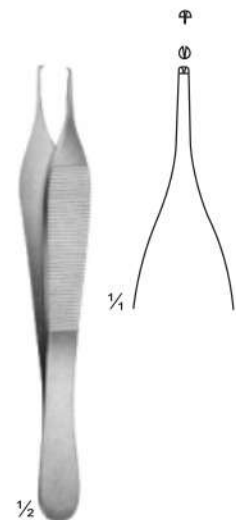

03-243  
ADSON  
120 mm

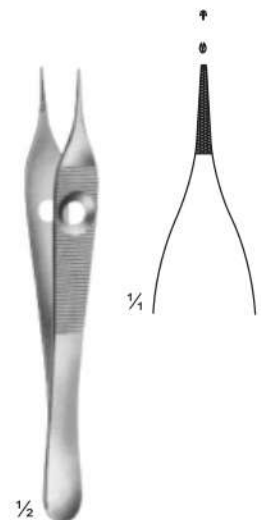

03-244  
ADSON  
120 mm



03-245  
ADSON  
120 mm



03-246  
ADSON  
150 mm



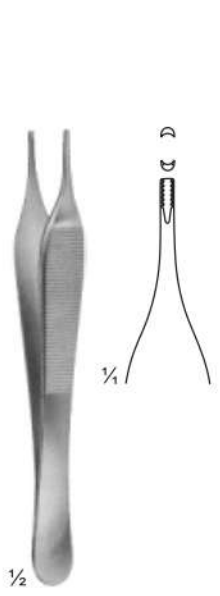
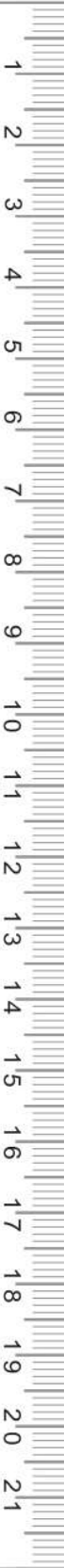

**03-247**  
**ADSON - BROWN**  
Non-traumatic  
120 mm

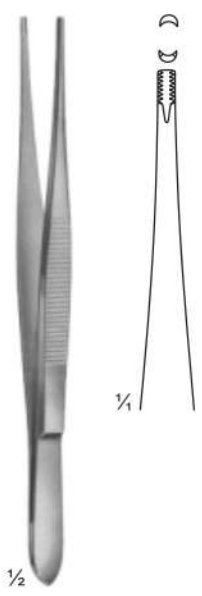

**03-248**  
**BROWN**  
120 mm

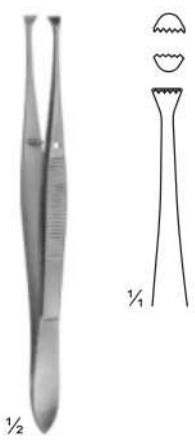

**03-249**  
**GRAEFE**  
110 mm

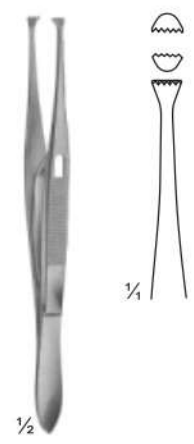

**03-250**  
**GRAEFE**  
With Catch  
110 mm

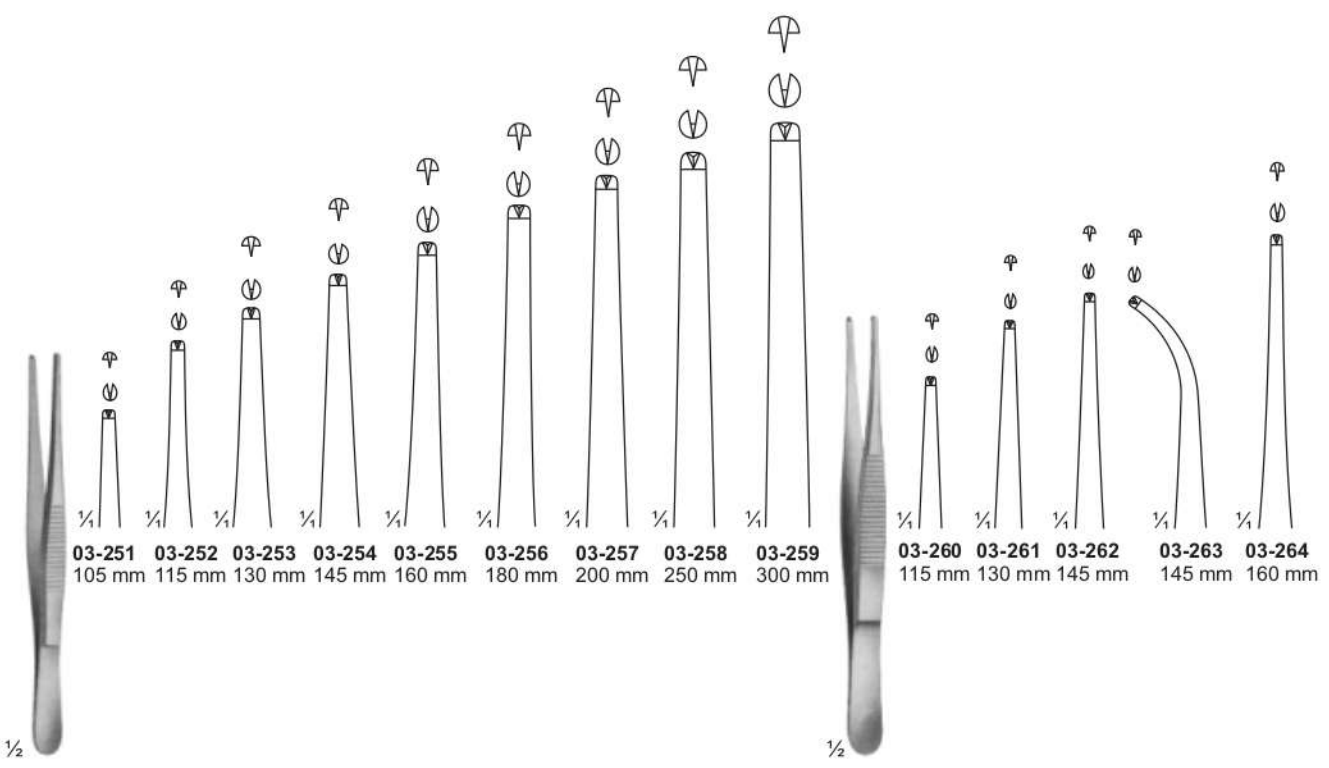

**03-251 - 259**  
**STANDARD**

**03-260 - 264**  
**GRAEFE**  
110 mm



Tissue Forceps  
Pinzette  
Pinzas De Tejido

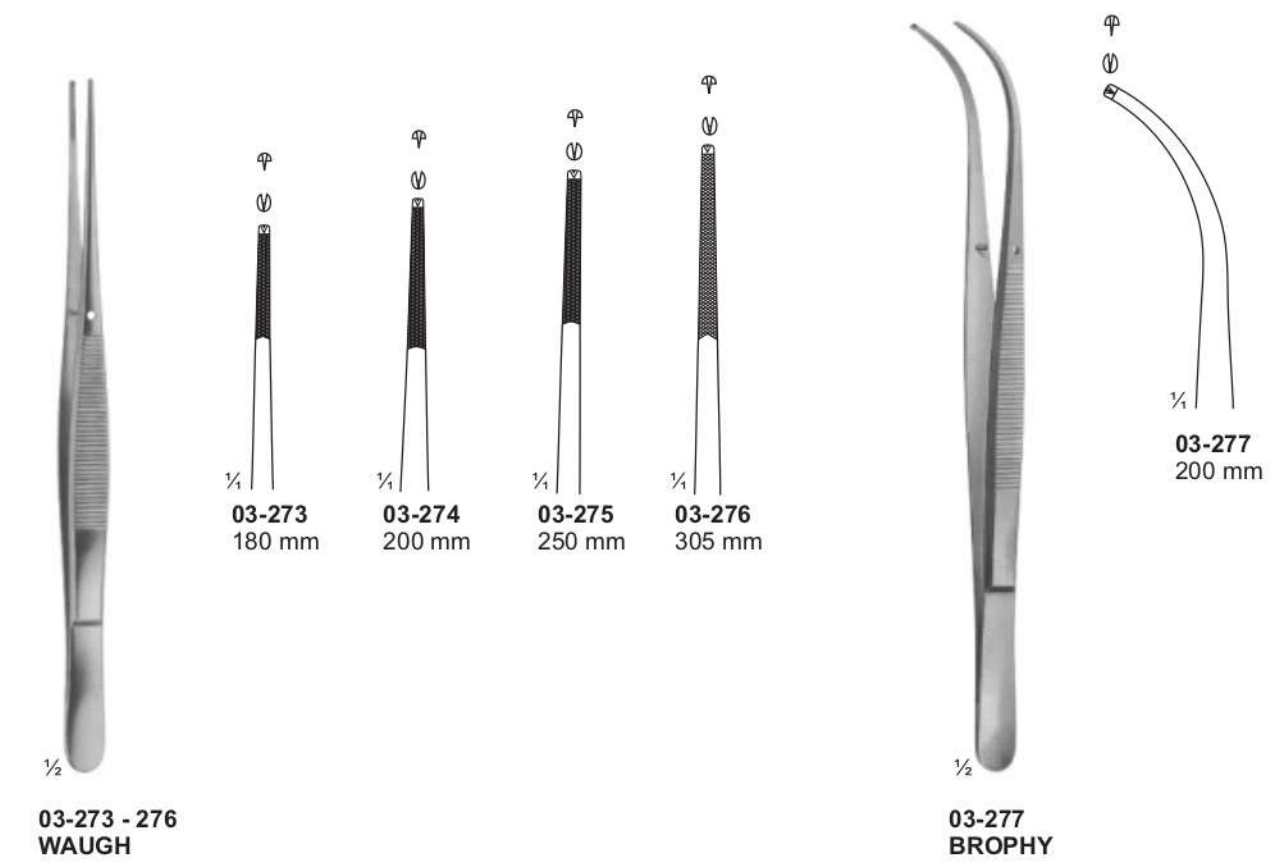
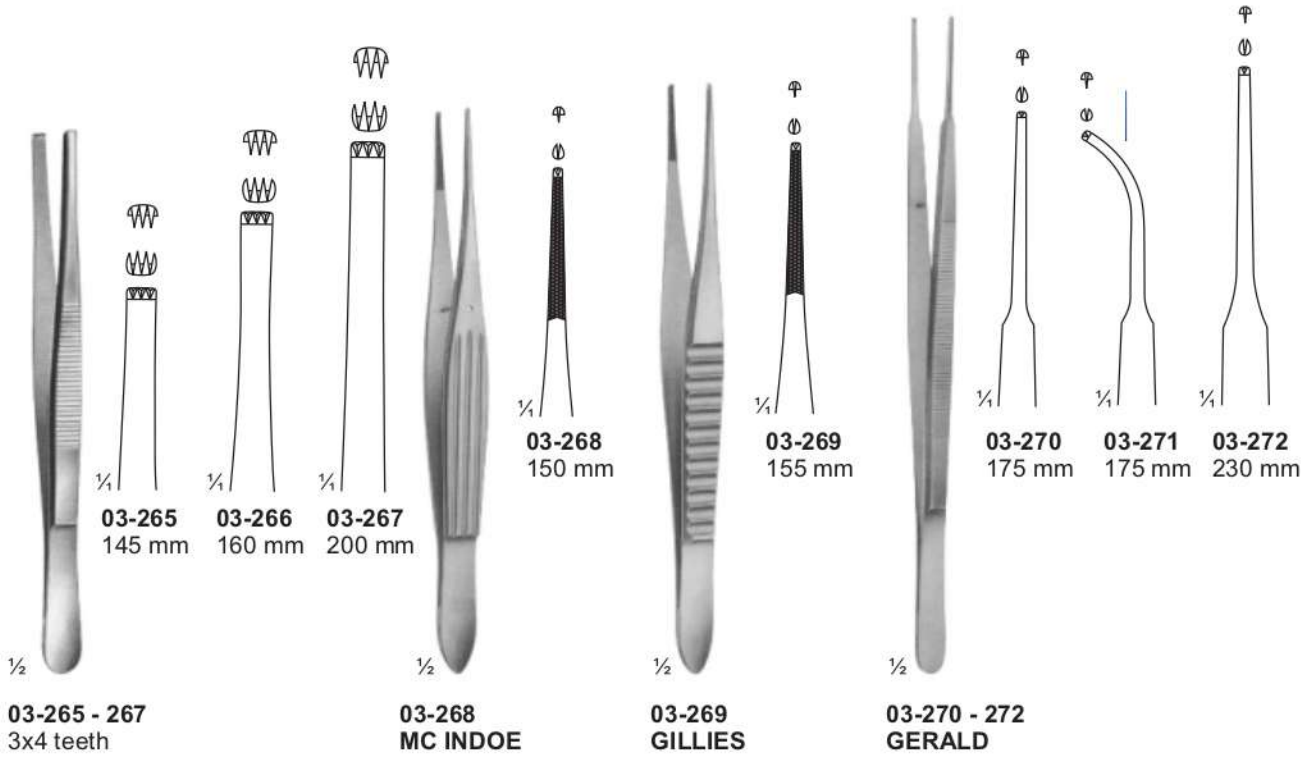

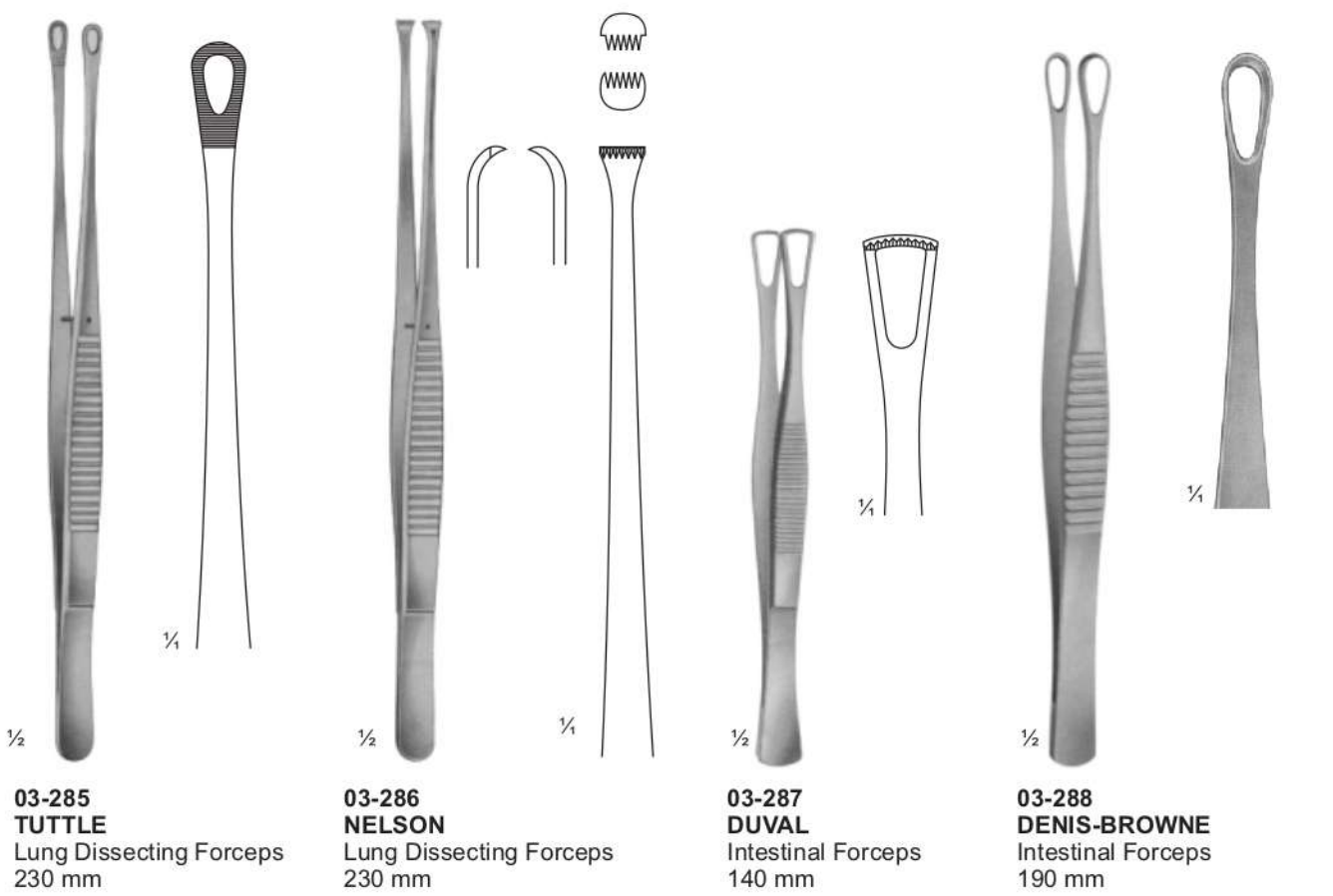
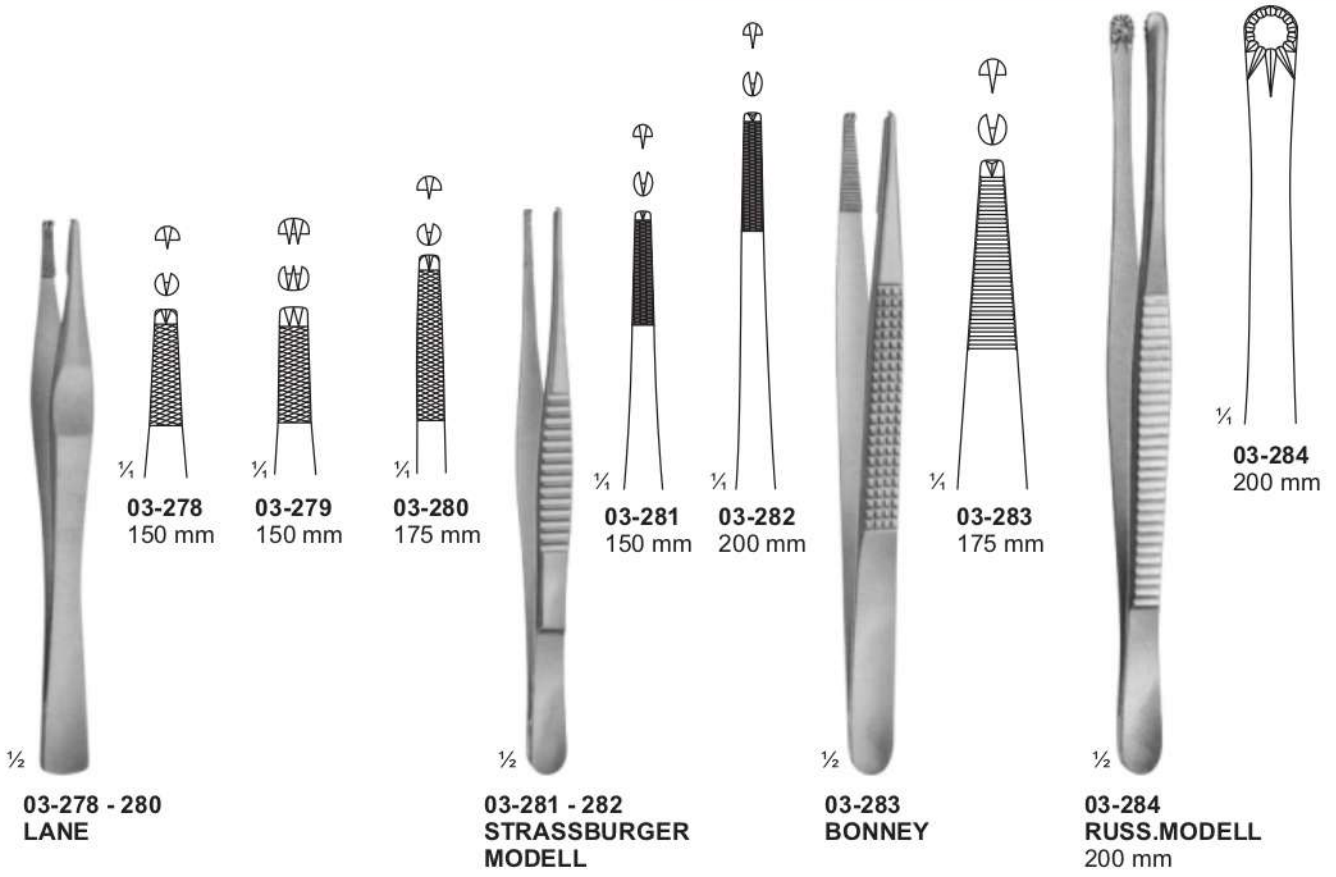

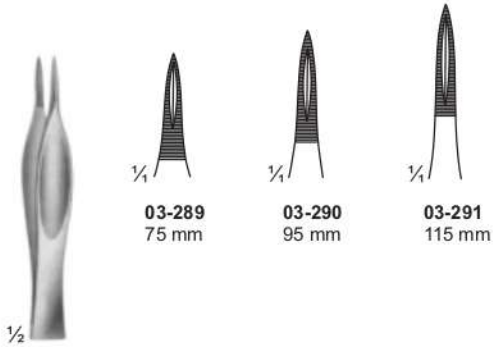

**03-289 - 291**  
 FEILCHENFELD

**03-289**  
 75 mm

**03-290**  
 95 mm

**03-291**  
 115 mm

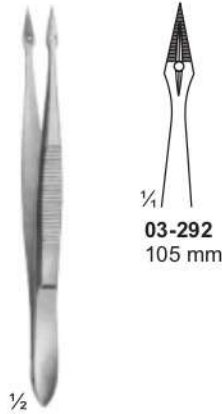

**03-292**  
 HUNTER

**03-292**  
 105 mm

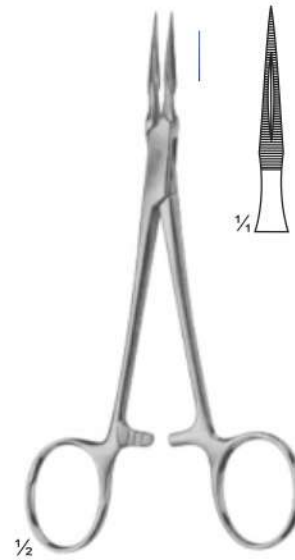

**03-293**  
 STIEGLITZ  
 140 mm

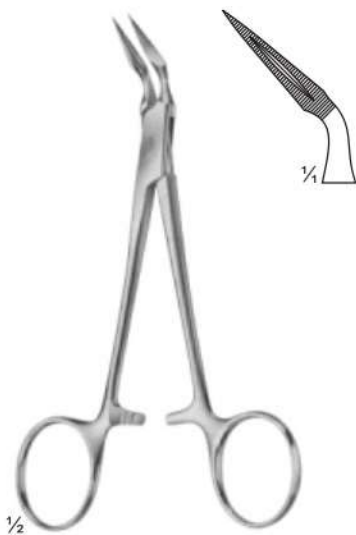

**03-294**  
 STIEGLITZ  
 140 mm

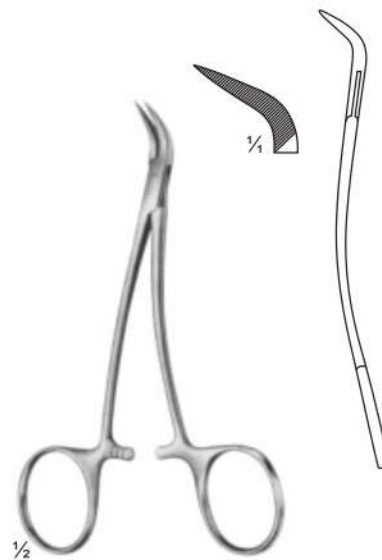

**03-295**  
 PEET  
 120 mm

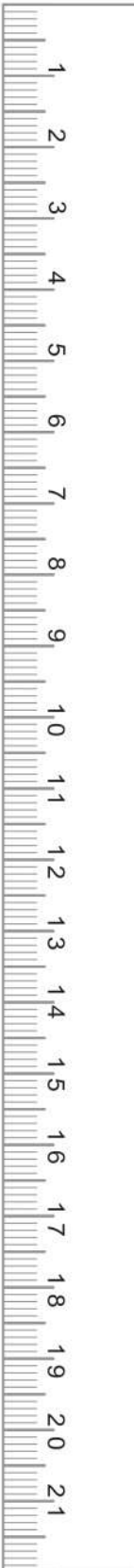

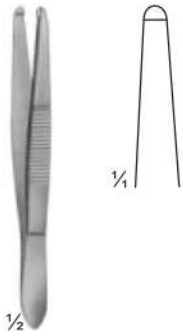
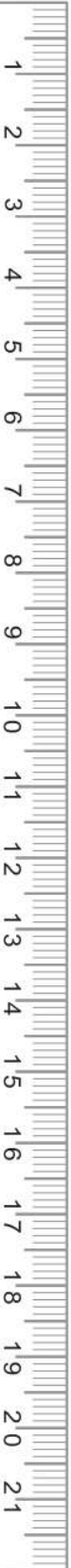

**03-296  
BEER**  
85 mm

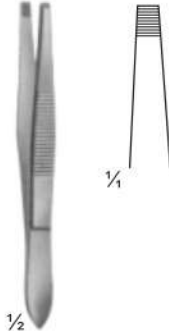

**03-297**  
85 mm

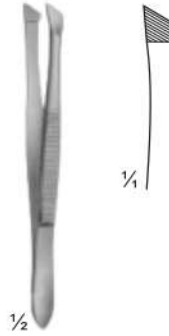

**03-298**  
85 mm

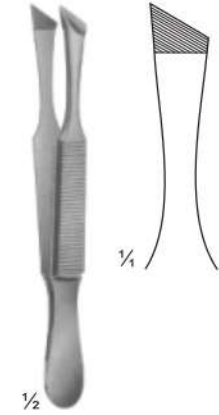

**03-299**  
105 mm

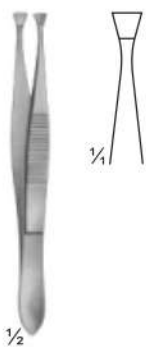

**03-300**  
105 mm

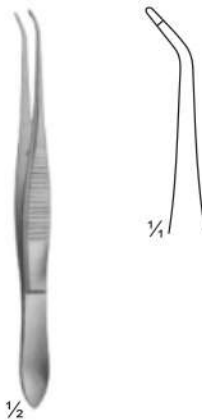

**03-301  
SAUPE**  
105 mm



**03-302  
SCHAAF**  
95 mm



**03-303**  
80 mm



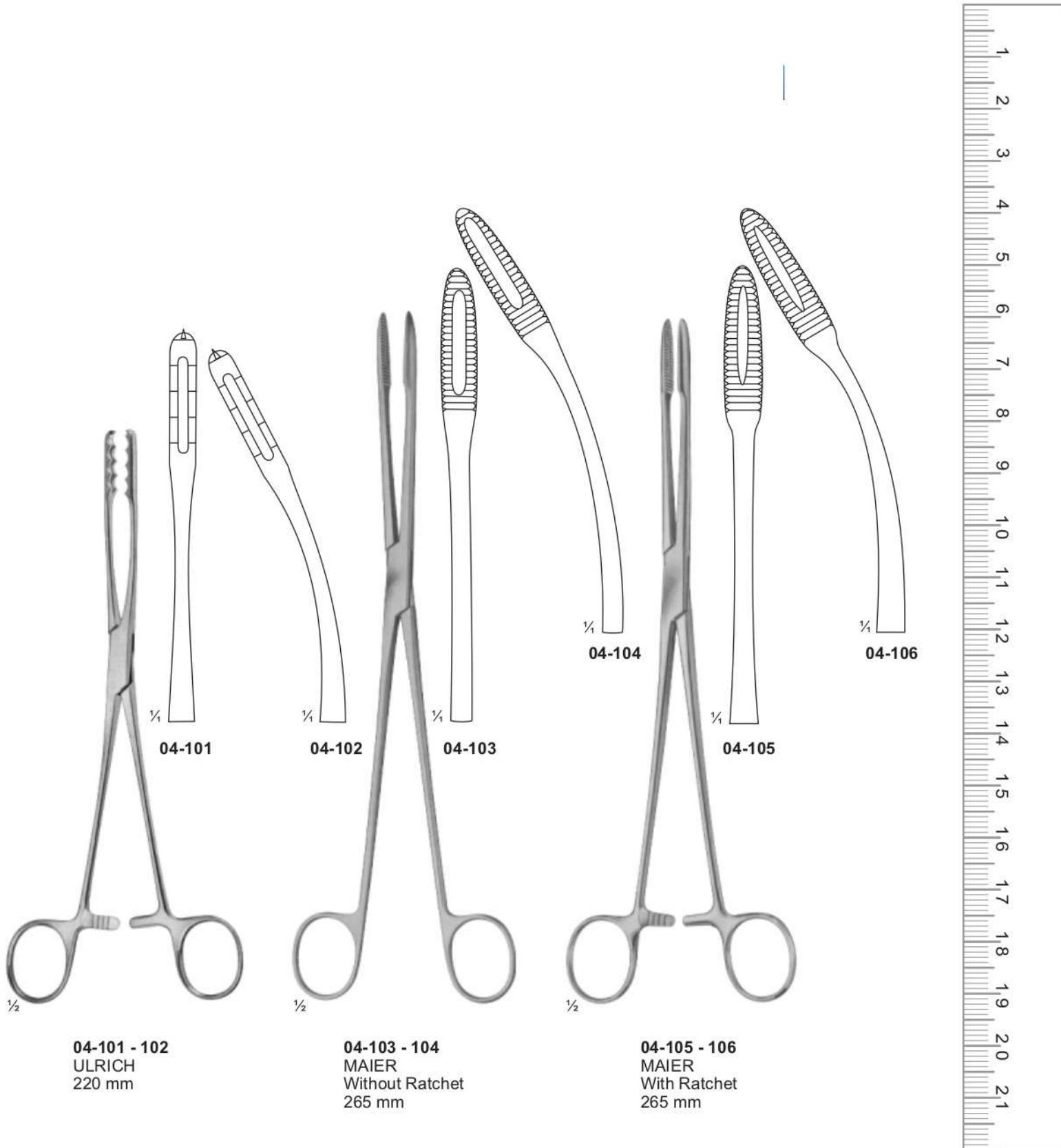

**04-101 - 102**  
 ULRICH  
 220 mm

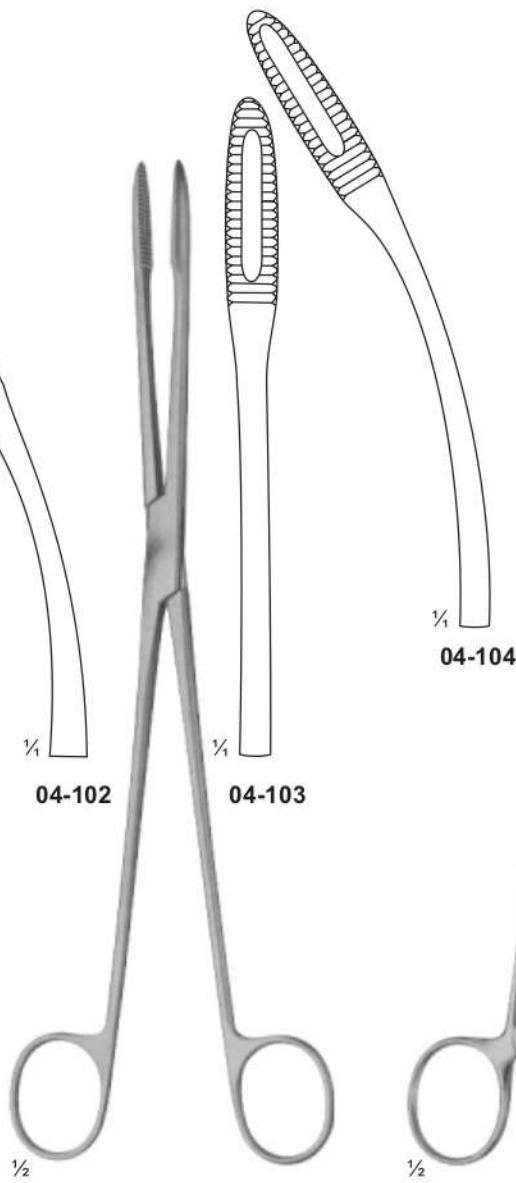

**04-103 - 104**  
 MAIER  
 Without Ratchet  
 265 mm

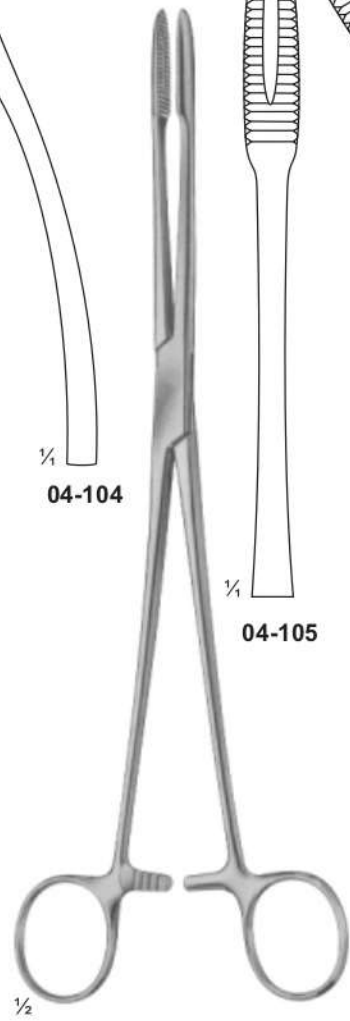

**04-105 - 106**  
 MAIER  
 With Ratchet  
 265 mm

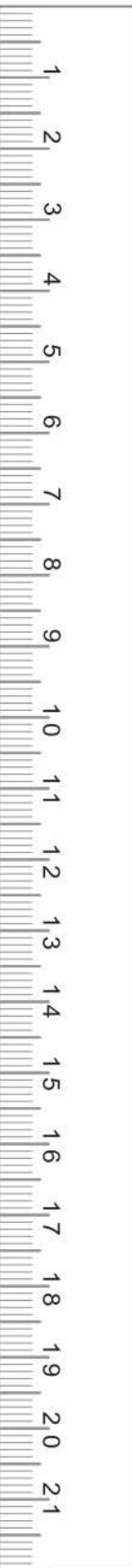

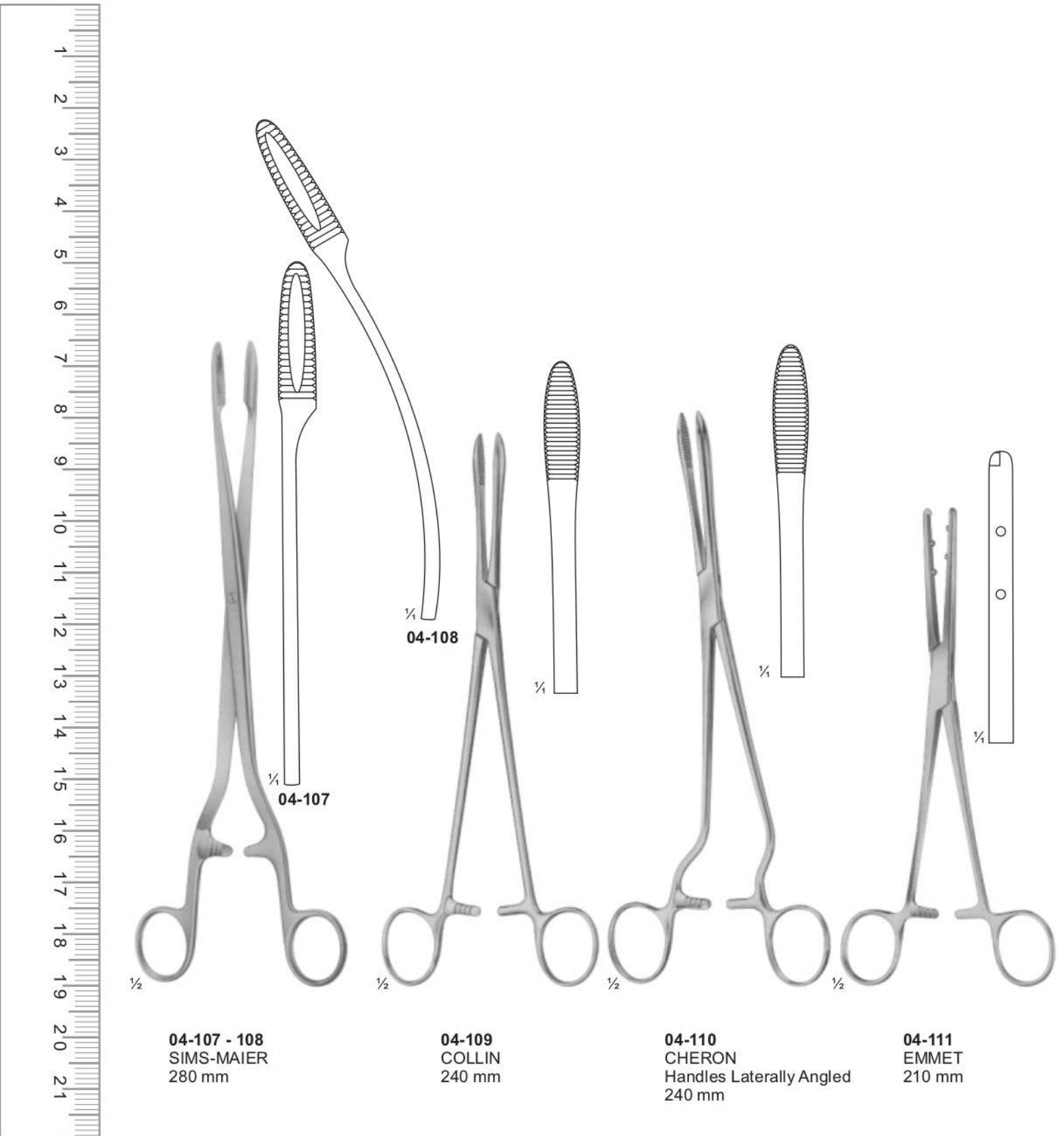

**04-107 - 108**  
SIMS-MAIER  
280 mm

**04-109**  
COLLIN  
240 mm

**04-110**  
CHERON  
Handles Laterally Angled  
240 mm

**04-111**  
EMMET  
210 mm



Dressing, Sponge Holding, Organ And Tissue Grasping  
Dressing, Sponge Holding, Organ-und Gewebetranpla  
Aderezo, Holding Esponja, De Órganos Y Tejidos Pinza:

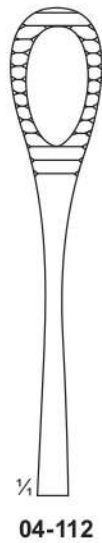
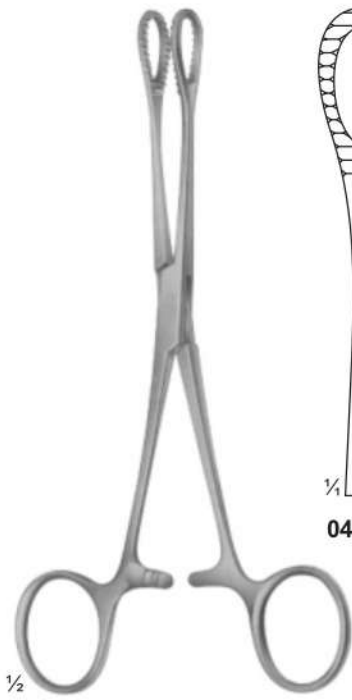

04-112

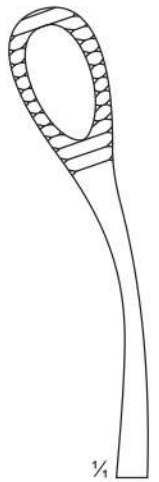

04-113



04-114  
180 mm



04-115  
250 mm

04-112 - 113  
FOERSTER-BALLENGER  
180 mm

04-114 - 115  
RAMPLEY

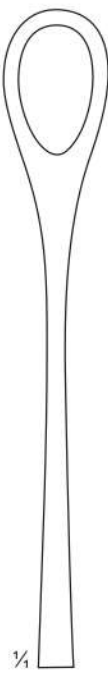
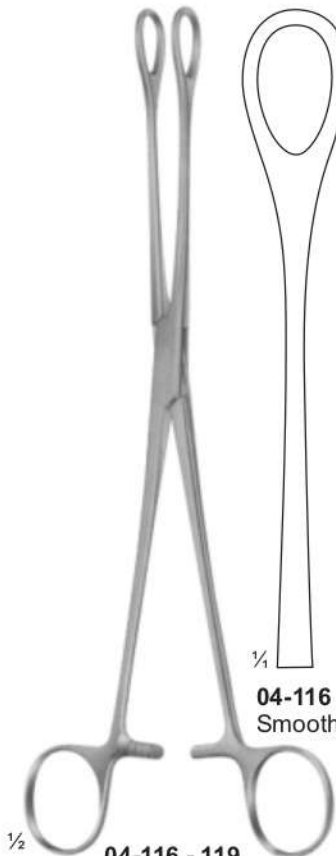

04-116  
Smooth Jaws

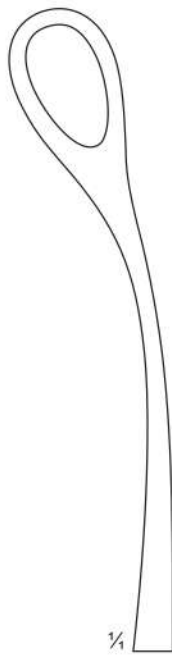

04-117  
Smooth Jaws

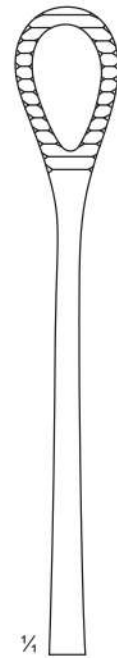

04-118  
Serrated Jaws

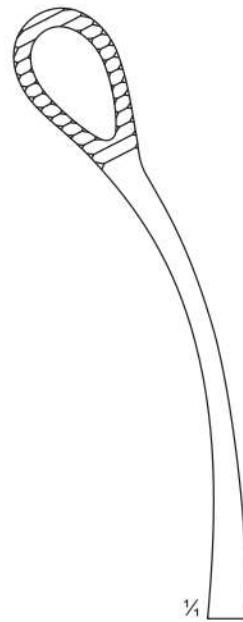

04-119  
Serrated Jaws



04-120  
PENNINGTON  
155 mm

04-116 - 119  
FOERSTER-BALLENGER  
240 mm

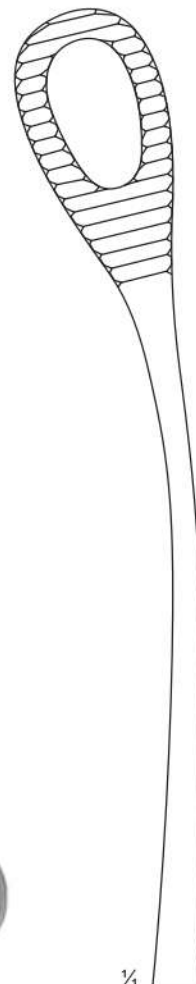
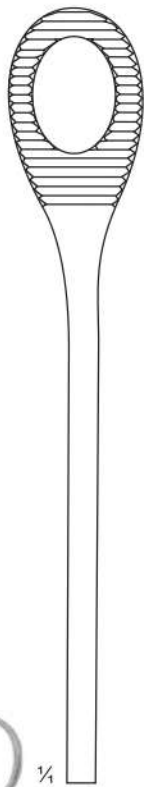
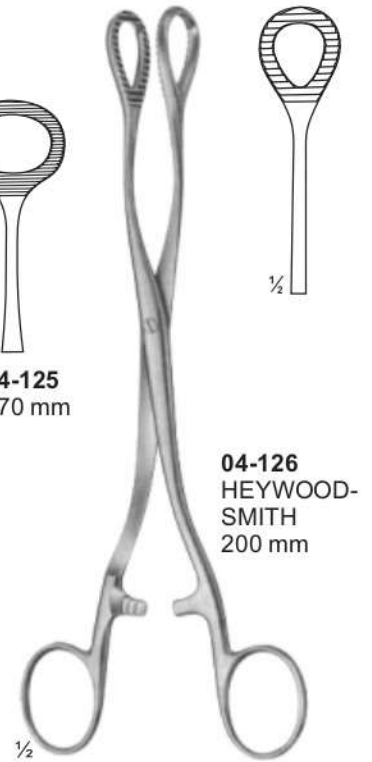
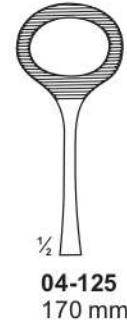
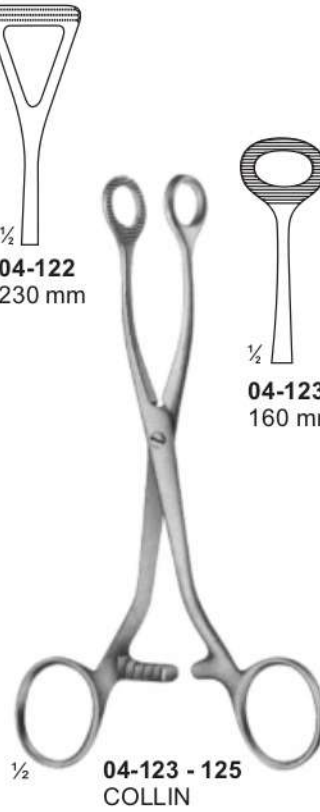
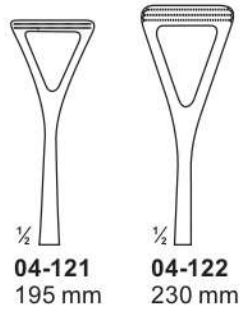
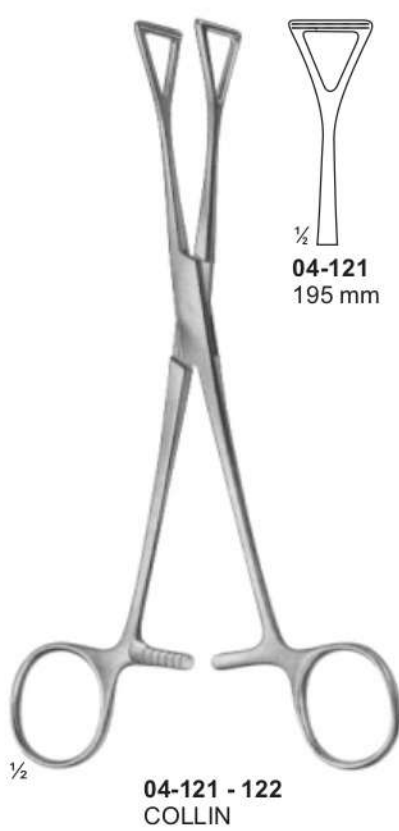



Artery Traction - And Tissue Grasping Forceps  
Artery Traction - Und Tissue Faßzange  
Tracción Arterial - Y Tejidos Pinzas De Agarre

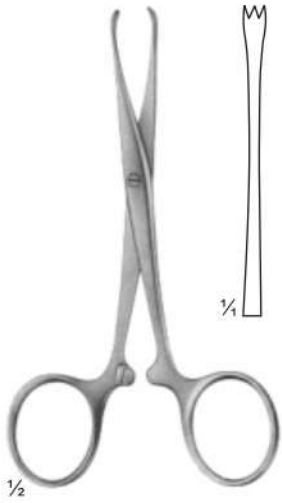

**04-129**  
CHAPUT  
2 x 3 teeth  
125 mm

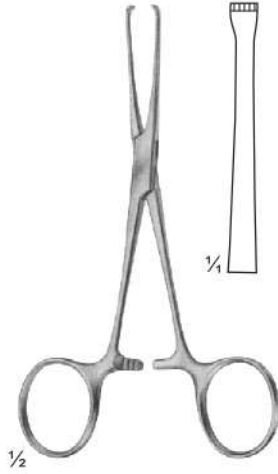

**04-130**  
BABY-ALLIS  
4 x 5 teeth  
130 mm

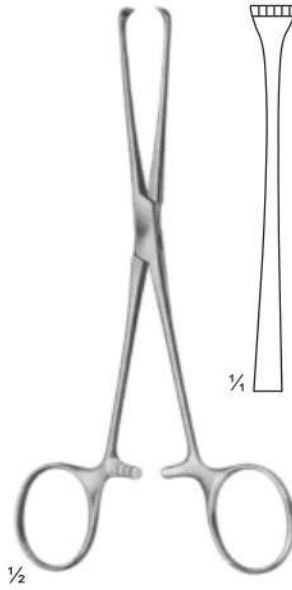

**04-131**  
BOYS-ALLIS  
5 x 6 teeth  
155 mm

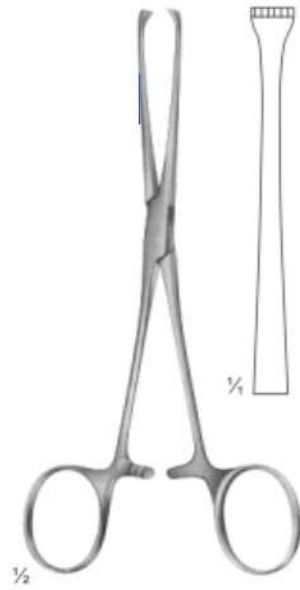

**04-132**  
ALLIS  
5 x 6 teeth  
155 mm

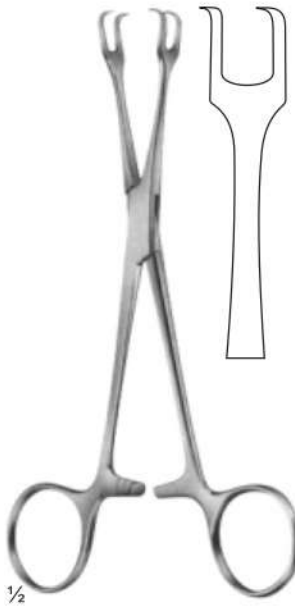

**04-133**  
LAHEY  
135 mm

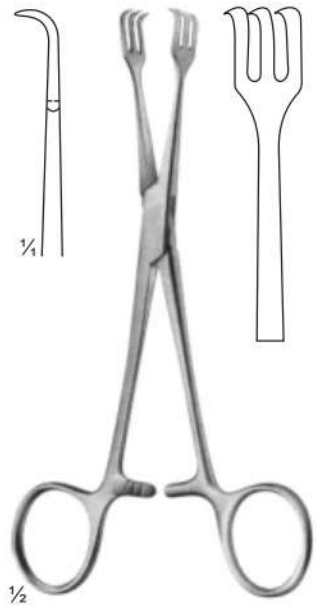

**04-134**  
LAHEY  
135 mm

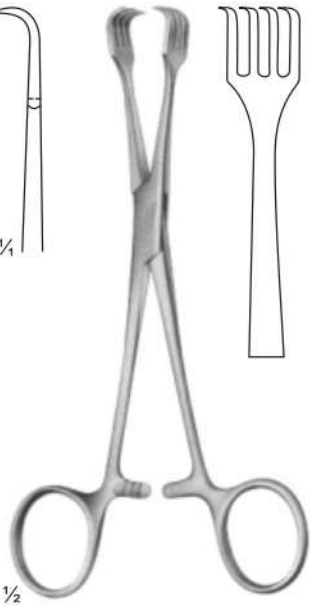

**04-135**  
BRAUN  
155 mm

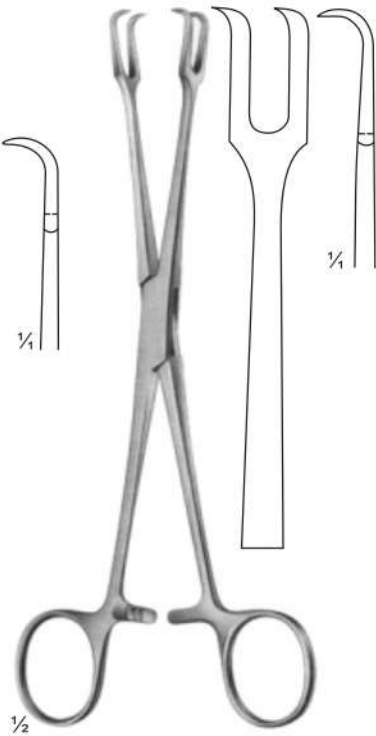

**04-136**  
MUSEUX  
200 mm



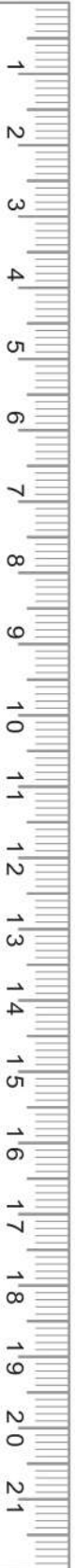

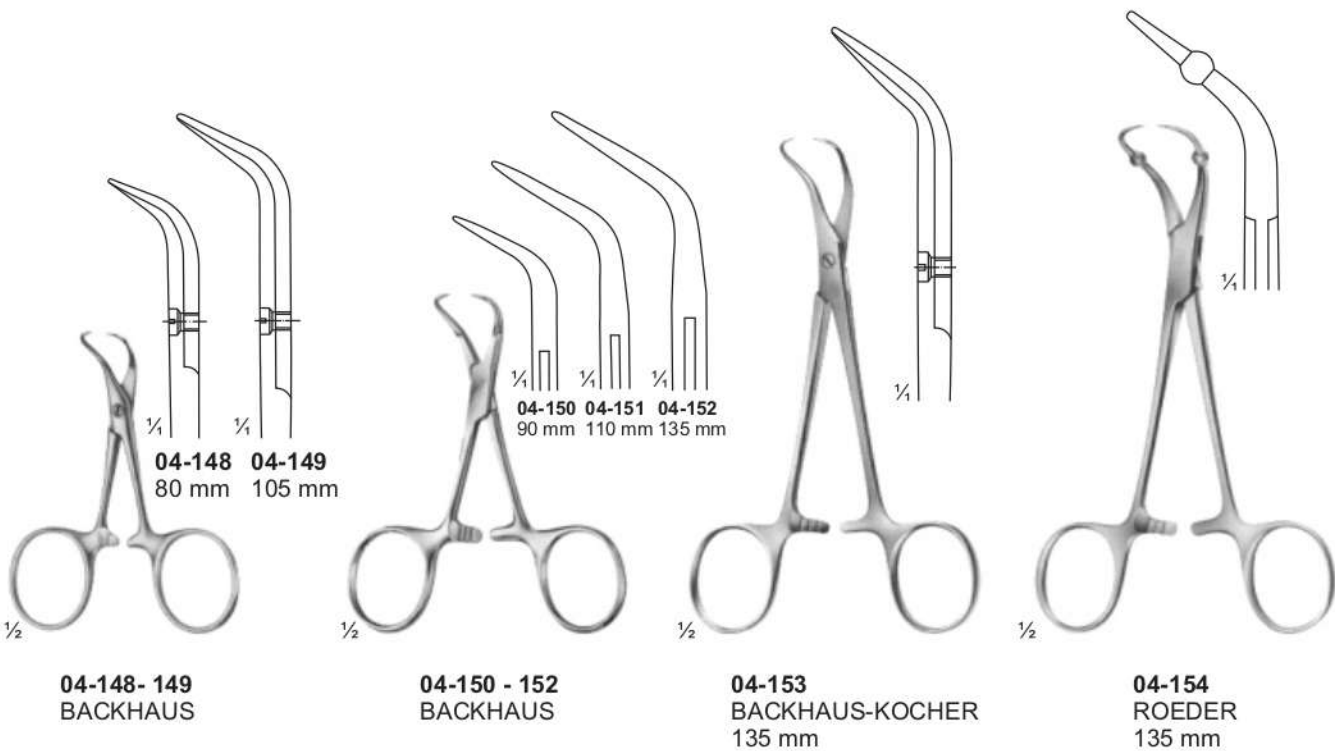
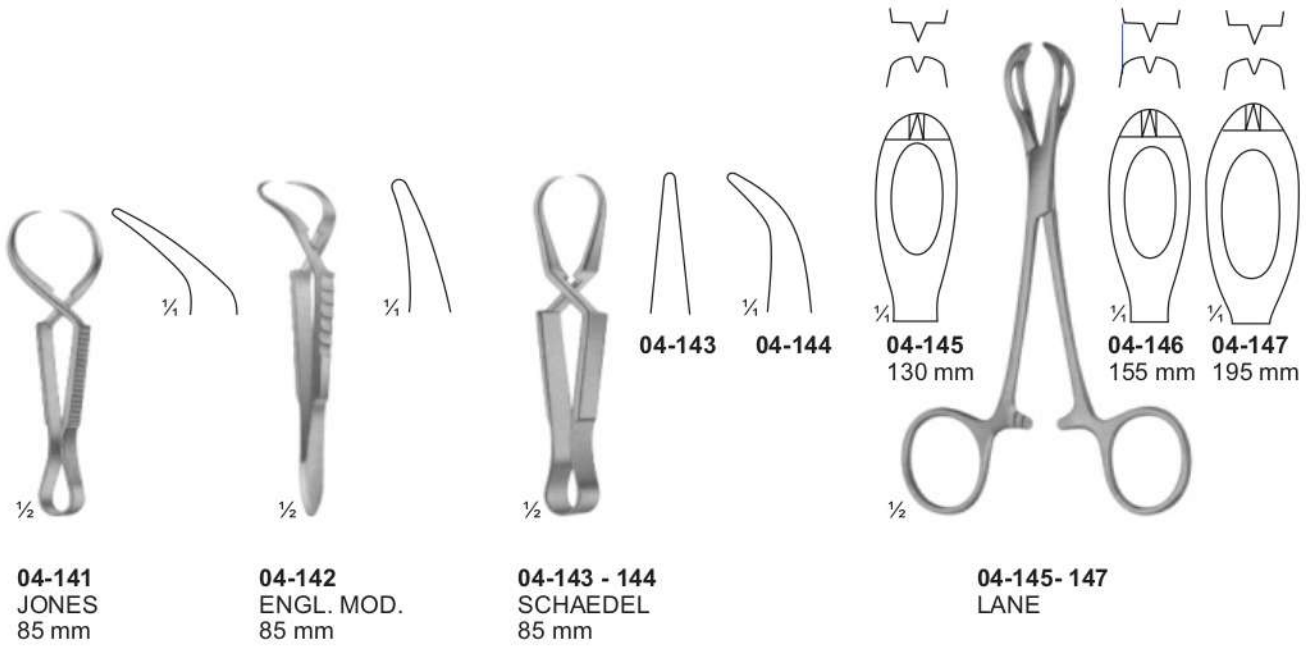

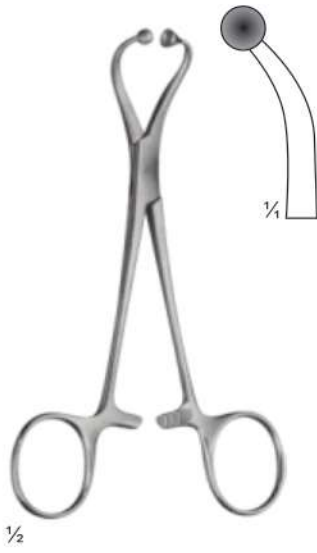
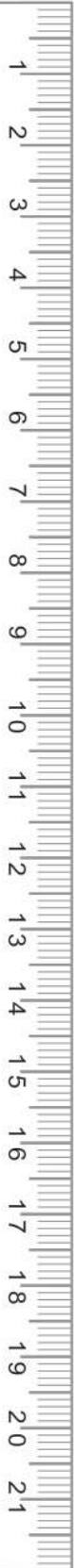

1/2

**04-155**  
for paper cloths  
140 mm

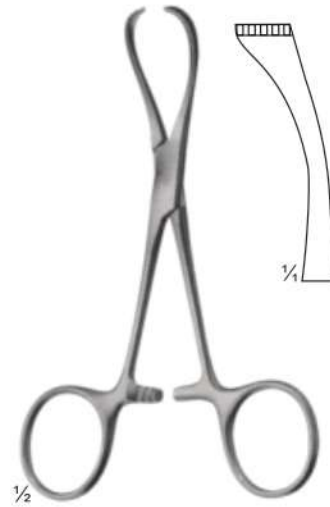

1/2

**04-156**  
LORNA  
non perforating  
130 mm



1/2

**04-157**  
BUNT  
105 mm



1/2

**04-158**  
MAYO  
140 mm



## Closing Force

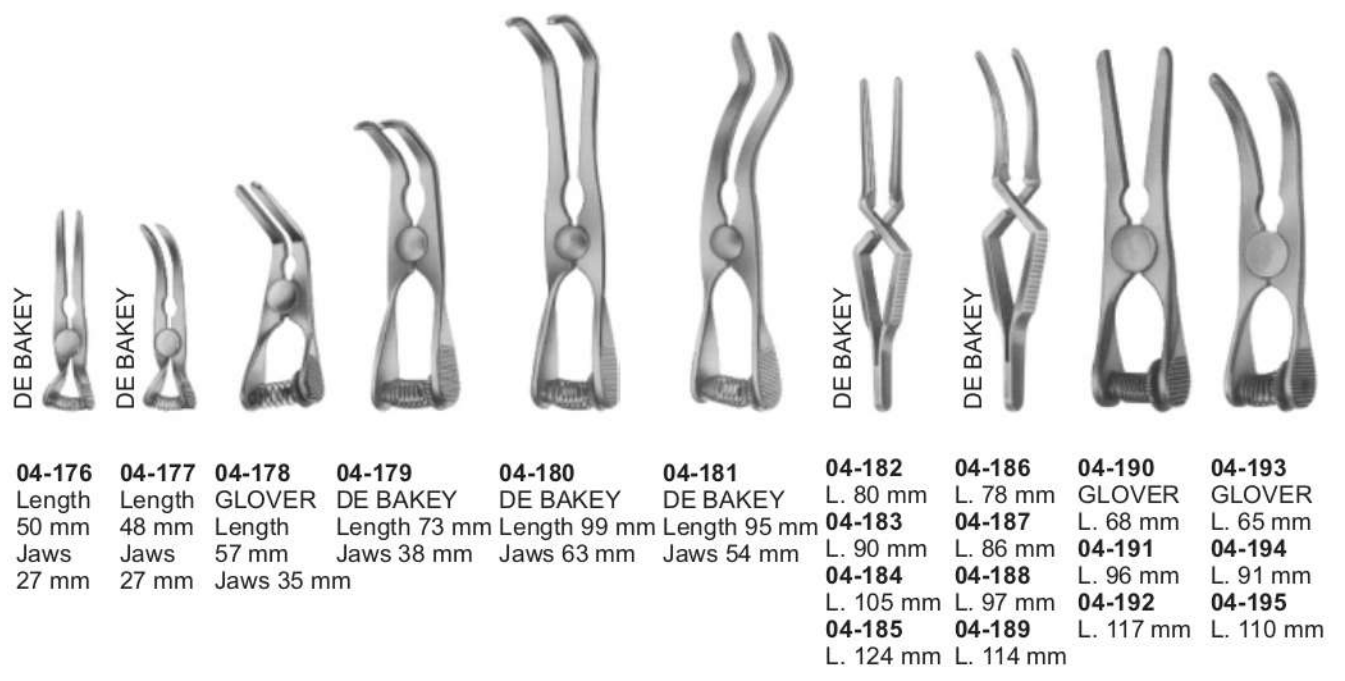
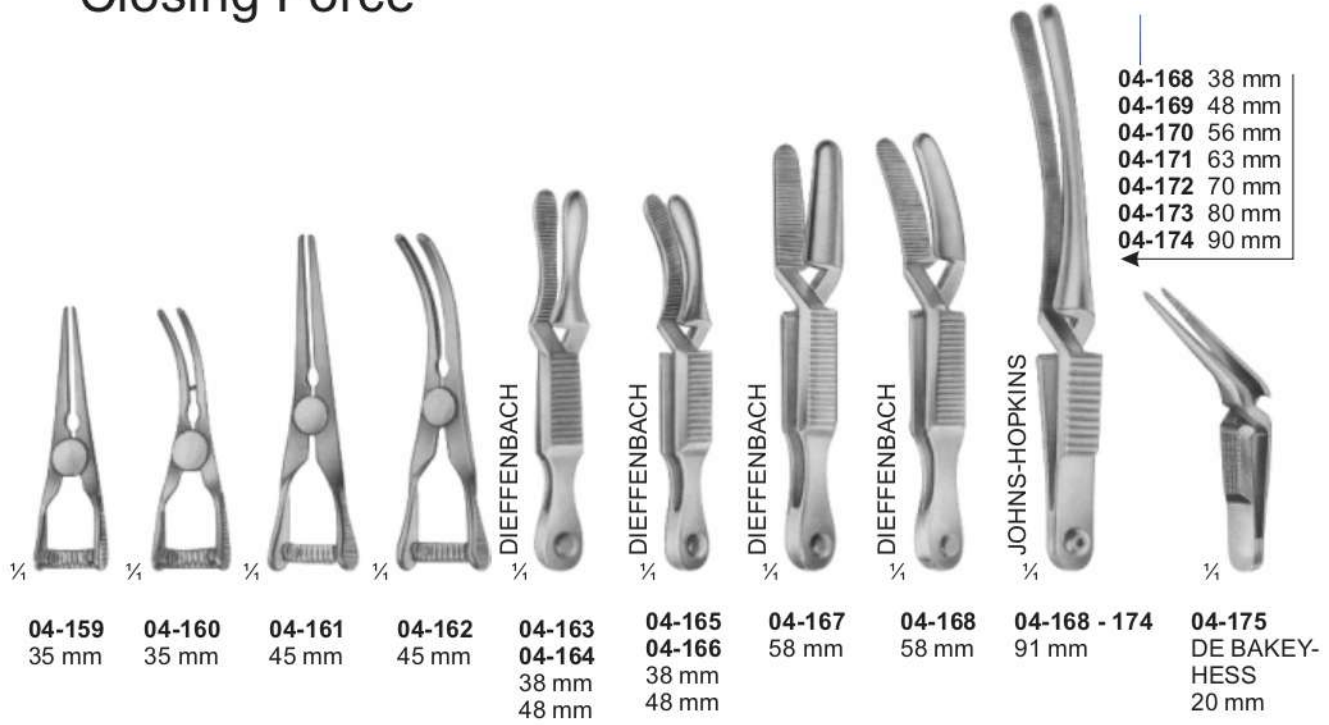

<b>04-159</b> 35 mm	<b>04-160</b> 35 mm	<b>04-161</b> 45 mm	<b>04-162</b> 45 mm	<b>04-163</b> <b>04-164</b> 38 mm 48 mm	<b>04-165</b> <b>04-166</b> 38 mm 48 mm	<b>04-167</b> 58 mm	<b>04-168</b> 58 mm	<b>04-168 - 174</b> 91 mm	<b>04-175</b> DE BAKEY- HESS 20 mm
<b>04-176</b> Length 50 mm Jaws 27 mm	<b>04-177</b> Length 48 mm Jaws 27 mm	<b>04-178</b> GLOVER Length 57 mm Jaws 35 mm	<b>04-179</b> DE BAKEY Length 73 mm Jaws 38 mm	<b>04-180</b> DE BAKEY Length 99 mm Jaws 63 mm	<b>04-181</b> DE BAKEY Length 95 mm Jaws 54 mm	<b>04-182</b> L. 80 mm <b>04-183</b> L. 90 mm <b>04-184</b> L. 105 mm <b>04-185</b> L. 124 mm	<b>04-186</b> L. 78 mm <b>04-187</b> L. 86 mm <b>04-188</b> L. 97 mm <b>04-189</b> L. 114 mm	<b>04-190</b> GLOVER L. 68 mm <b>04-191</b> L. 96 mm <b>04-192</b> L. 117 mm	<b>04-193</b> GLOVER L. 65 mm <b>04-194</b> L. 91 mm <b>04-195</b> L. 110 mm



**04-196 -199**  
HALSTED-MOSQUITO  
125 mm

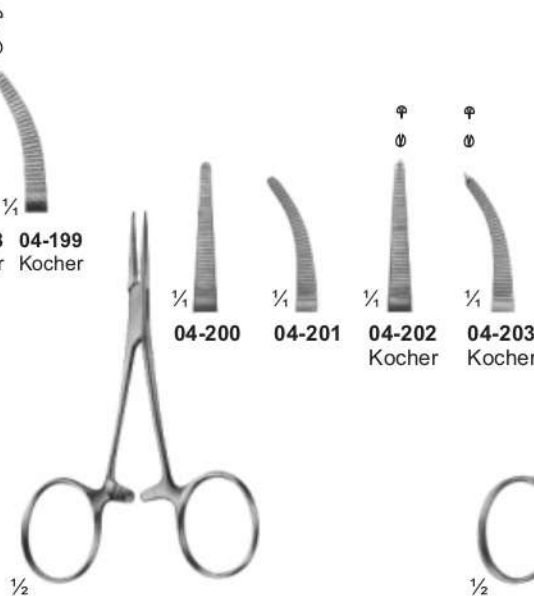

**04-200 - 203**  
BABY-MOSQUITO  
(HARTMANN)  
100 mm

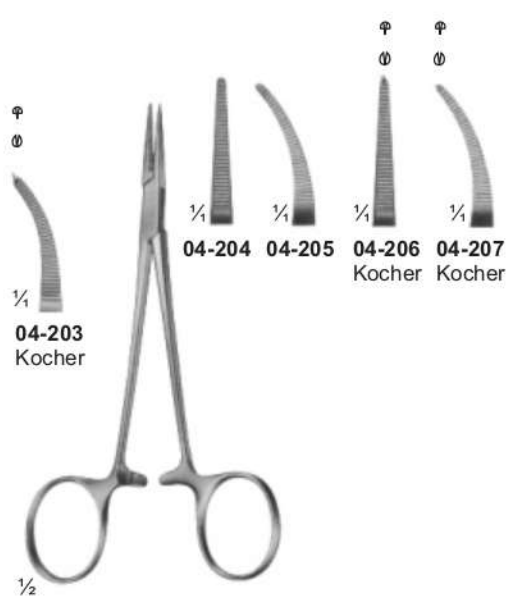

**04-204 - 207**  
MICRO-HALSTED  
125 mm



**04-208 - 209**  
PROVIDENCE-HOSPITAL  
140 mm



**04-210 - 211**  
KELLY  
140 mm

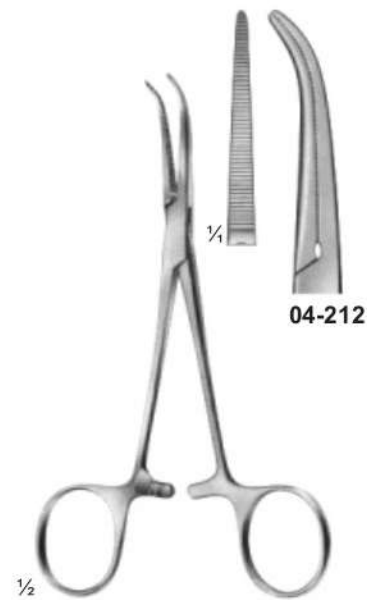

**04-212**  
DANDY  
Curved sideways  
140 mm



Delicate Haemostatic Forceps  
Zarte Arterienklemme  
Delicadas Pinzas Hemostáticas

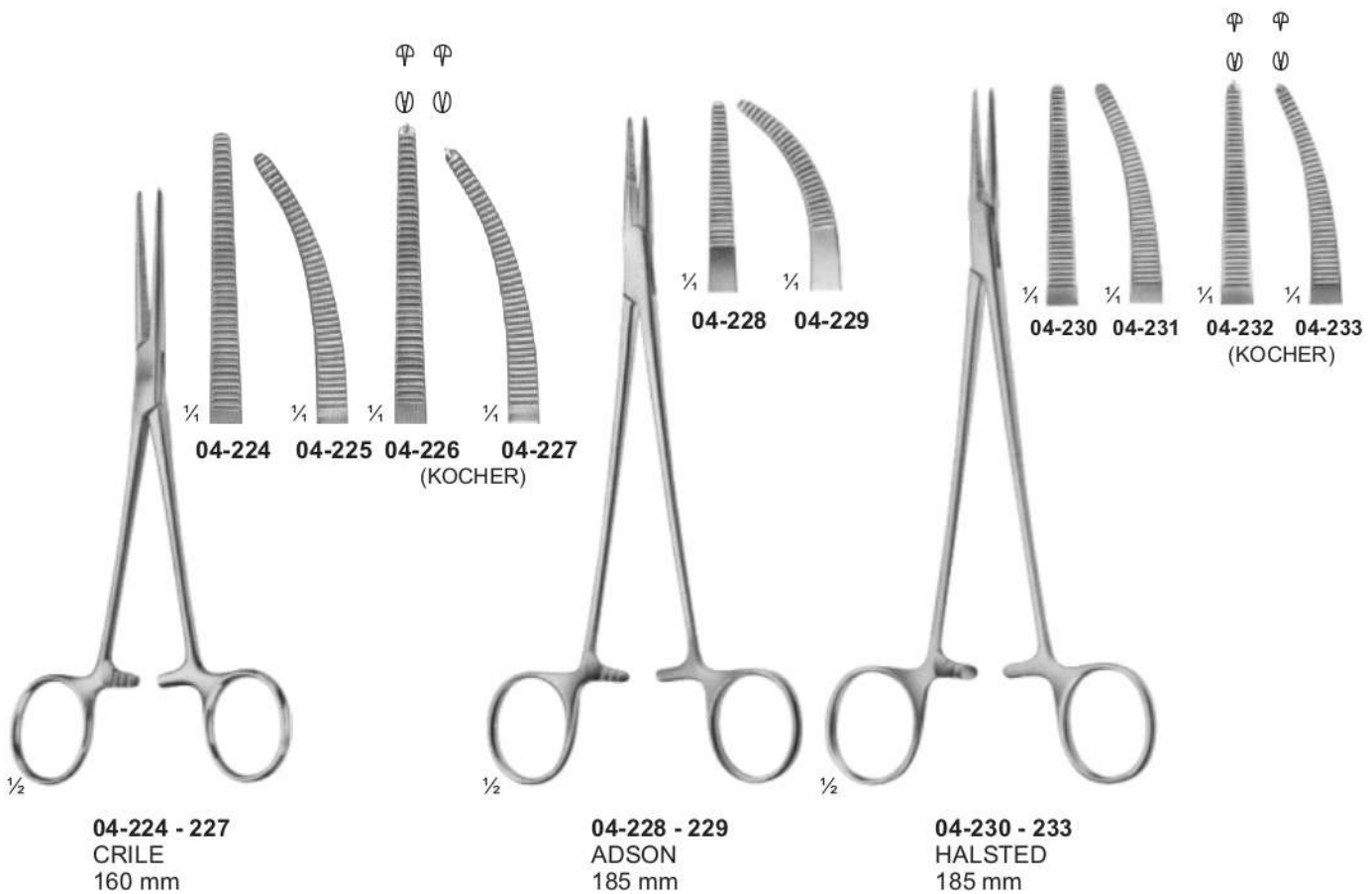
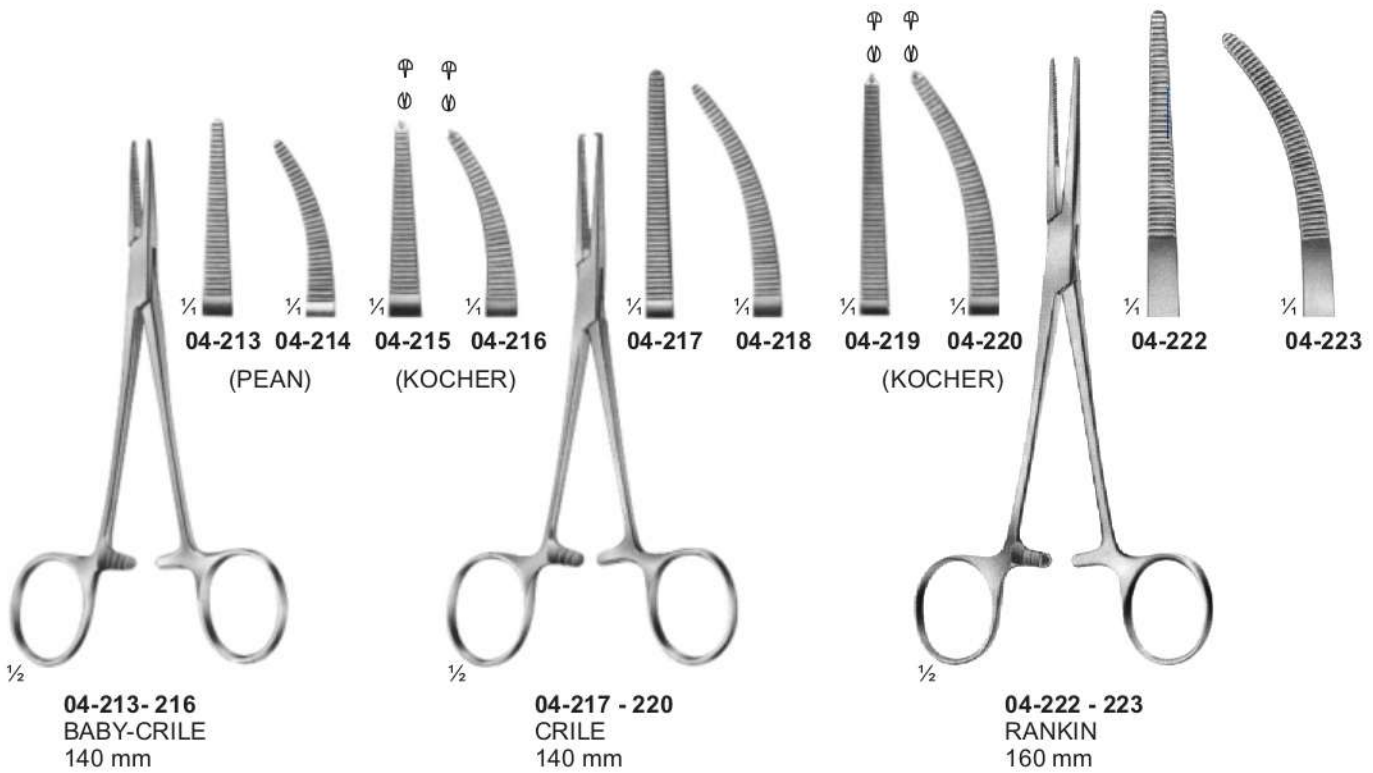

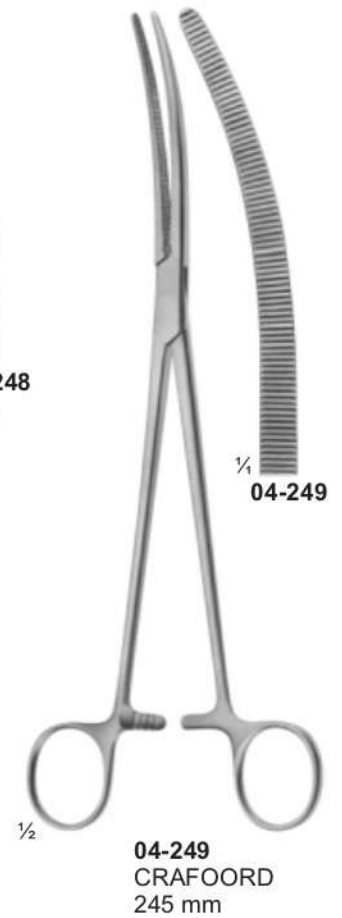
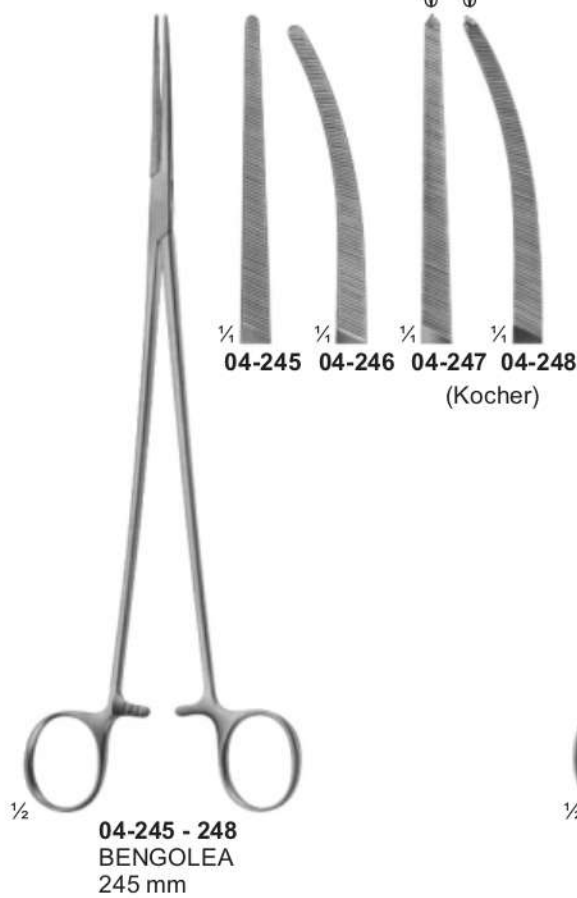
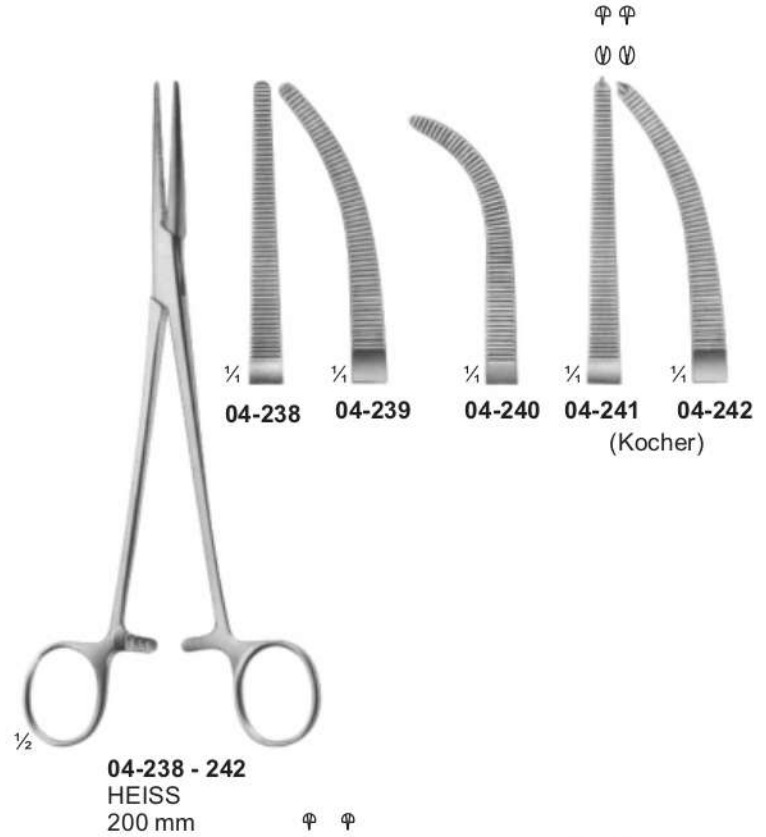
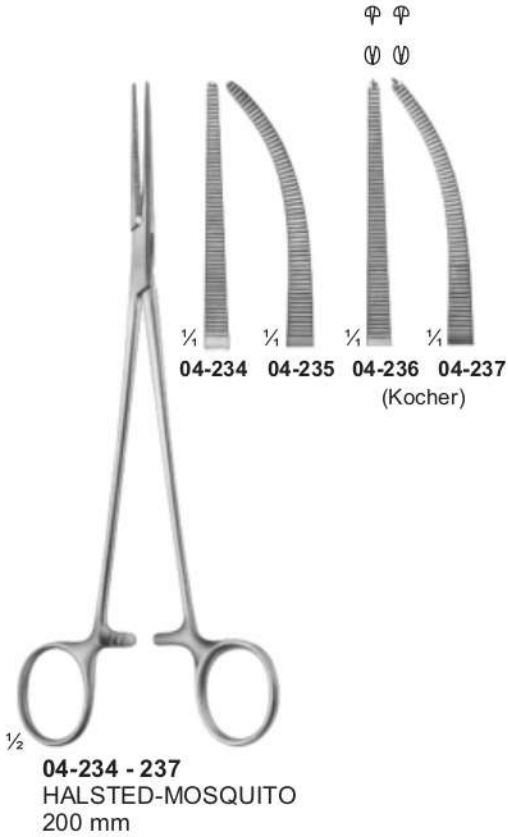
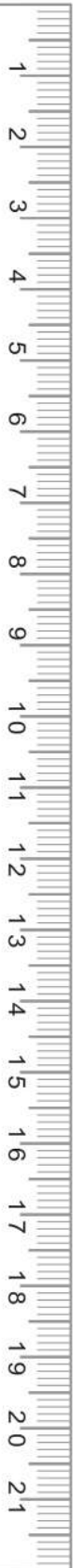



# Haemostatic Forceps Arterienklemme Pinzas Hemostáticas

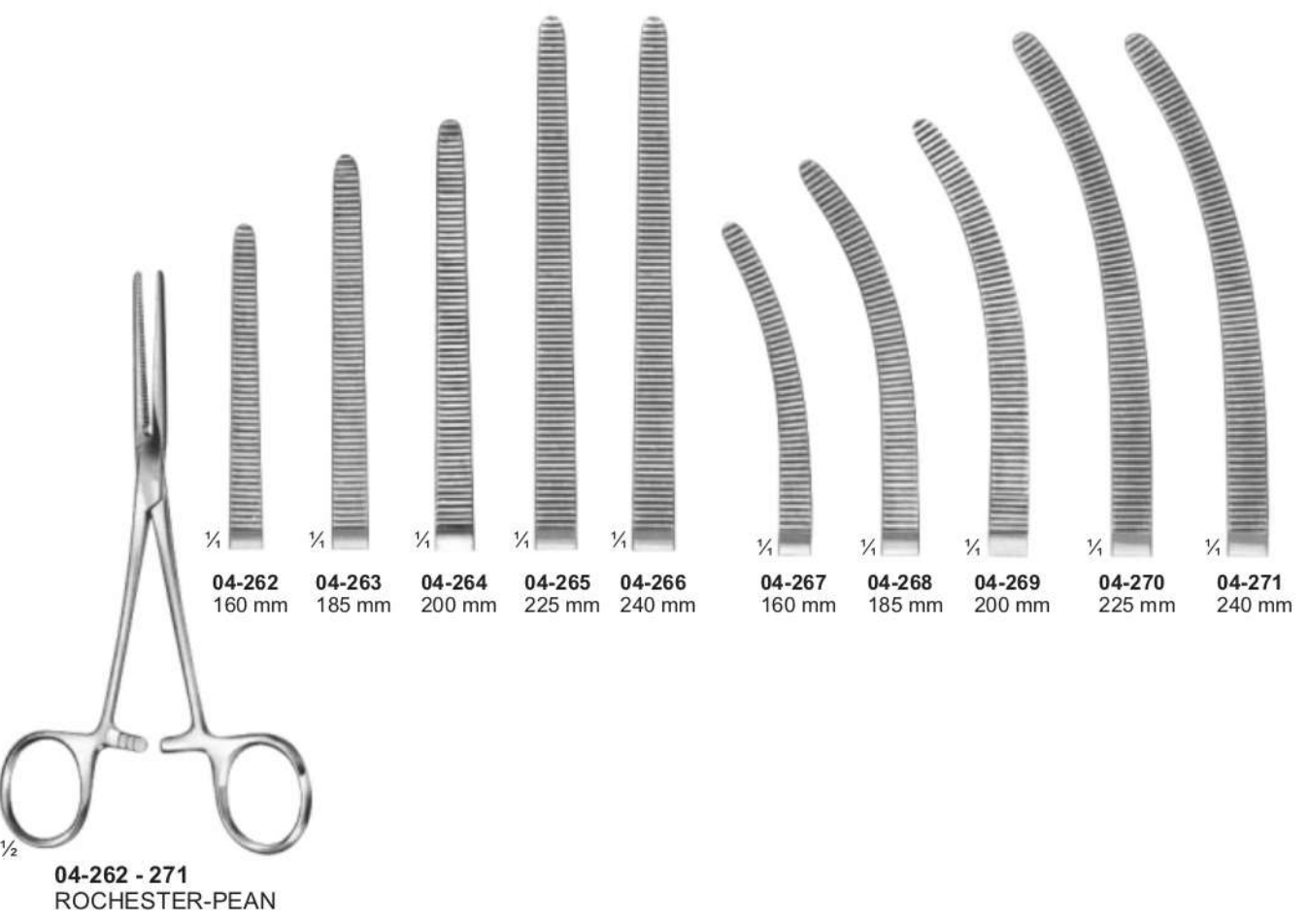
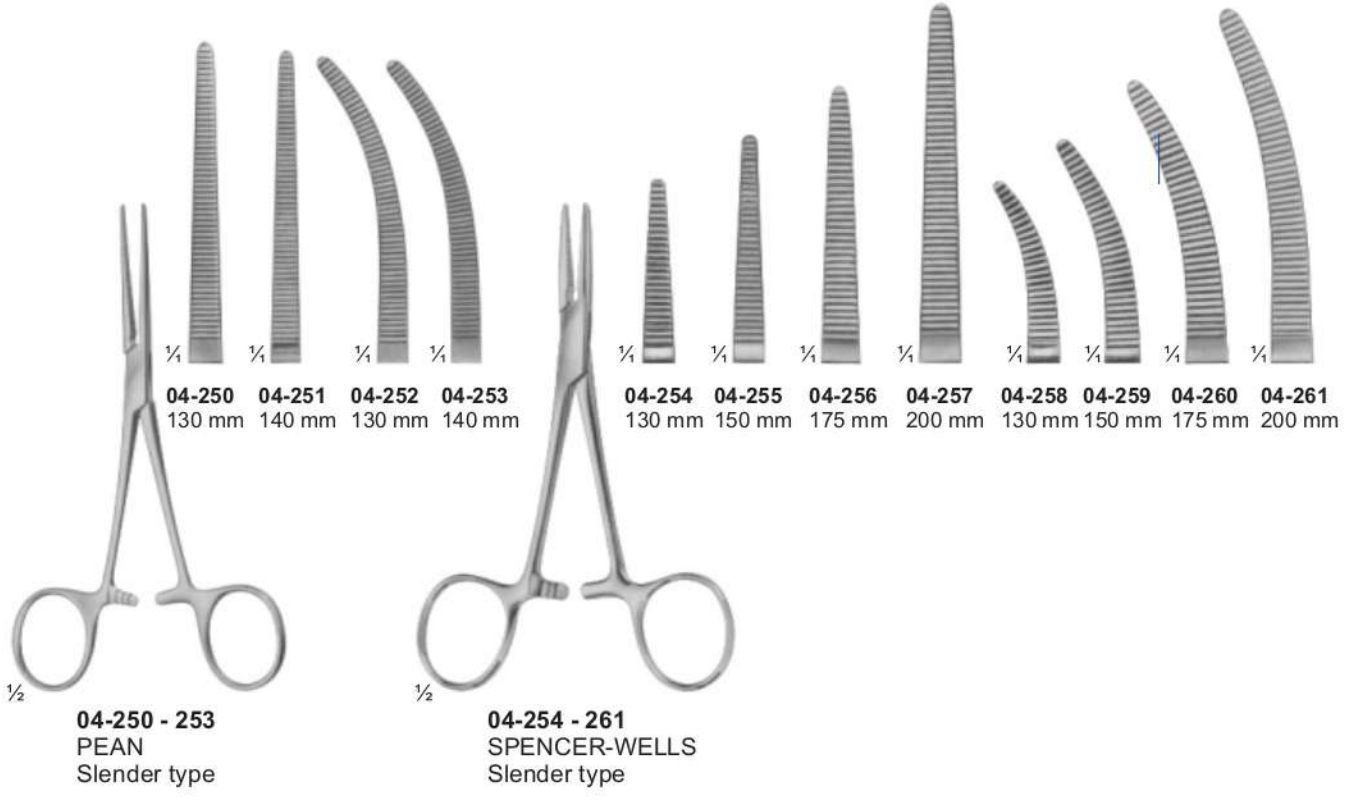

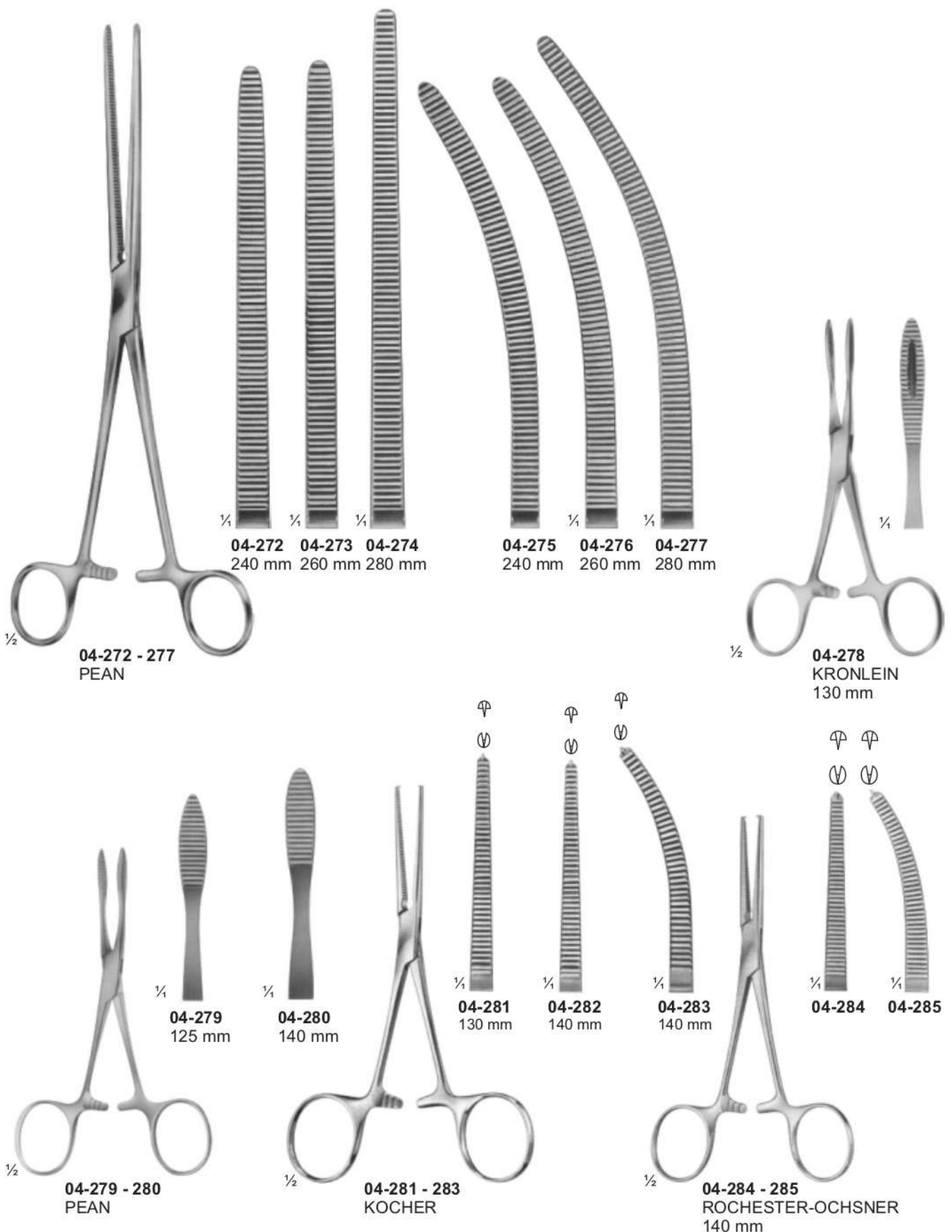



1/2

**04-286 - 292**  
**KOCHER-OCHSNER (STR)**

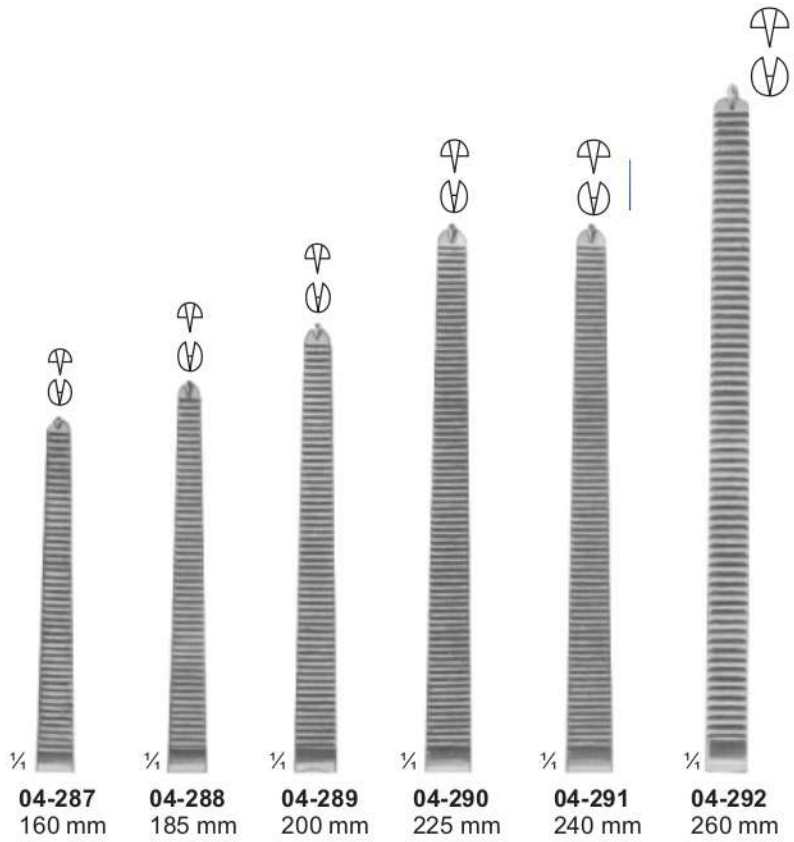

1/2

**04-293 - 298**  
**KOCHER-OCHSNER (CVD)**

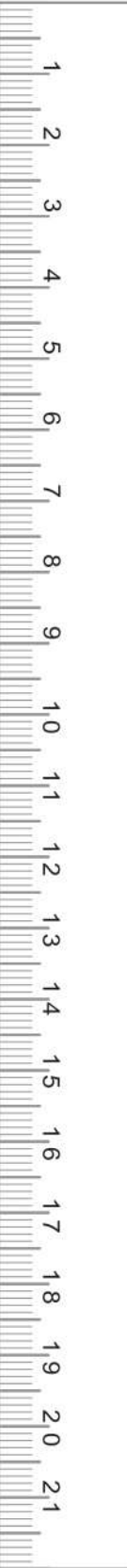
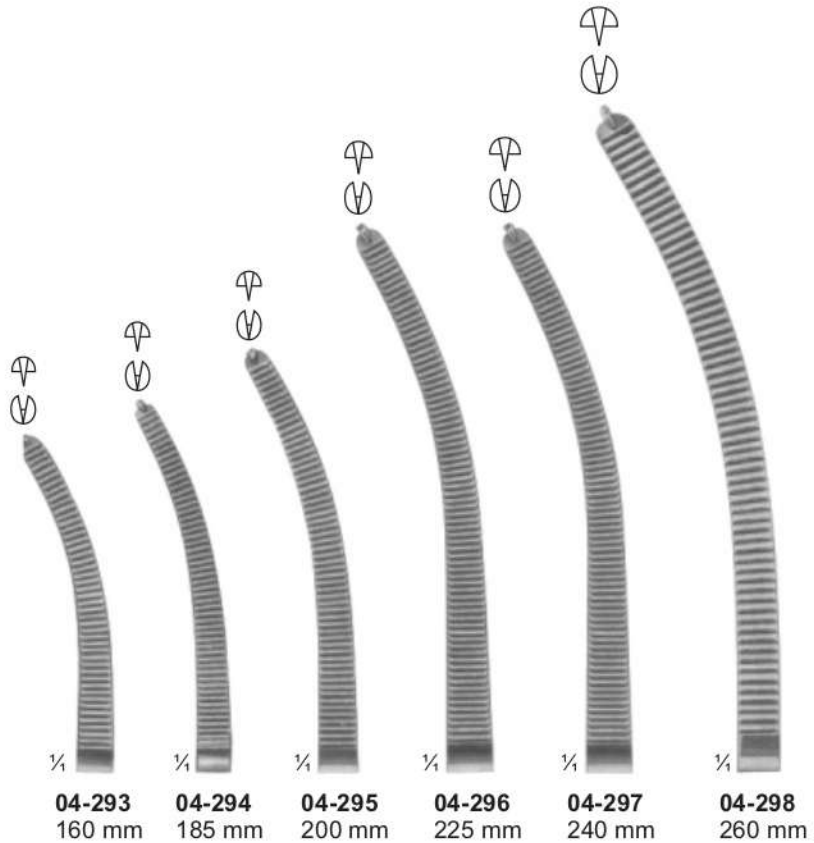

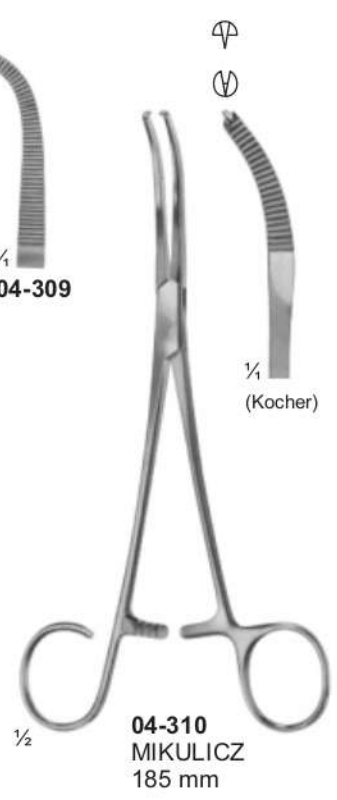
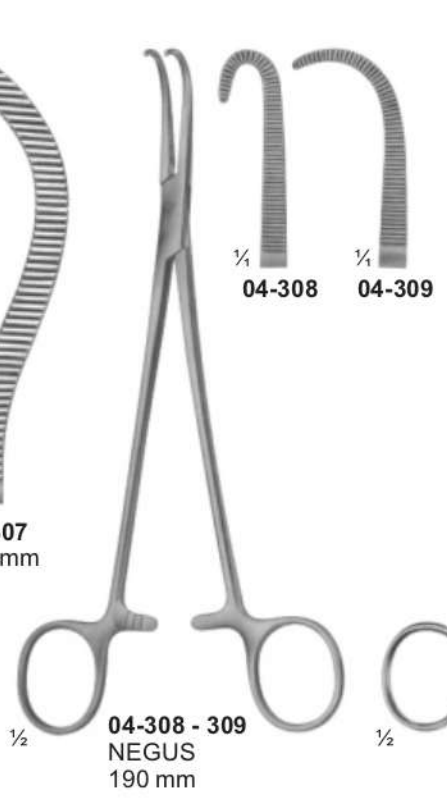
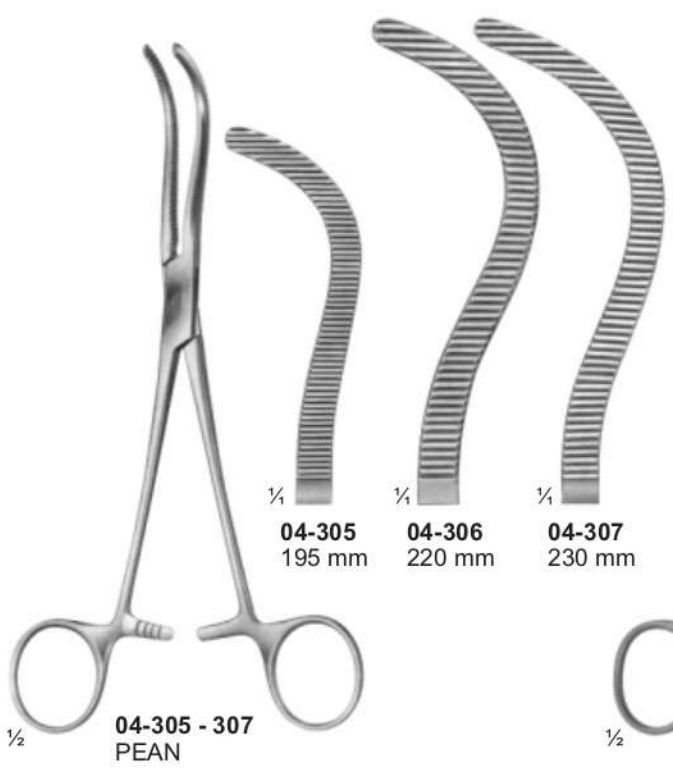
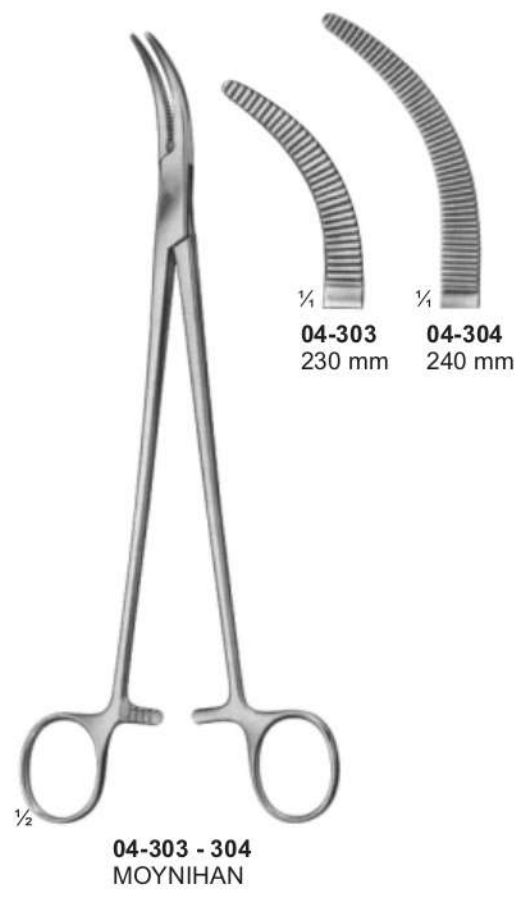
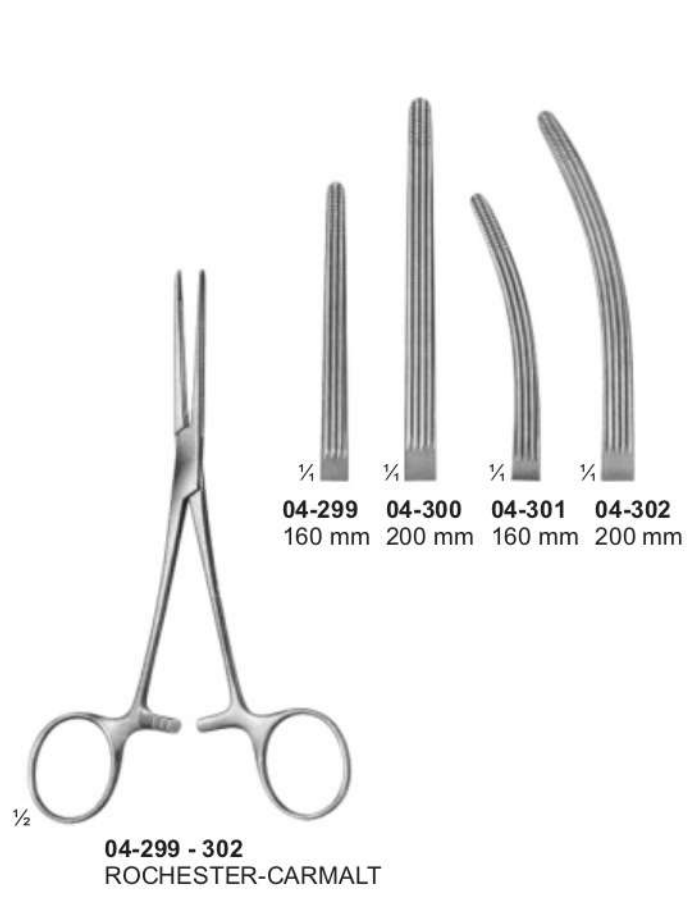





Dissecting- and Ligature Forceps  
Dissecting-und Ligaturklemmen  
La disección y ligadura Pinzas

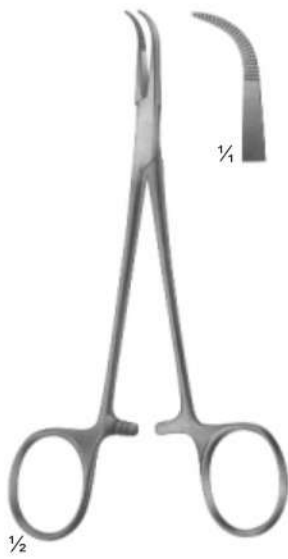

**04-311**  
MICRO-ADSON  
140 mm



**04-312**  
BABY-OVERHOLT  
135 mm

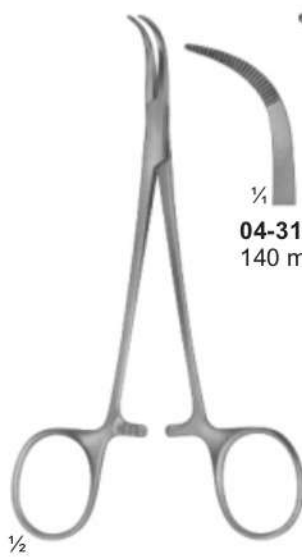

**04-313**  
140 mm



**04-314**  
180 mm

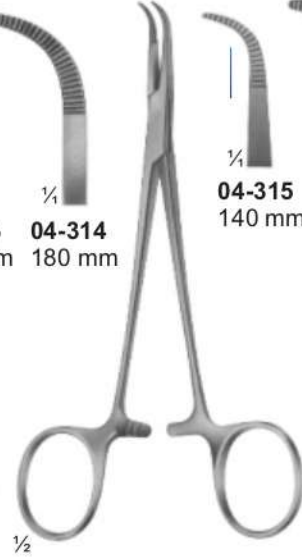

**04-315**  
140 mm

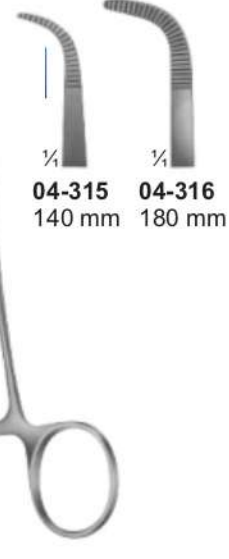

**04-316**  
180 mm

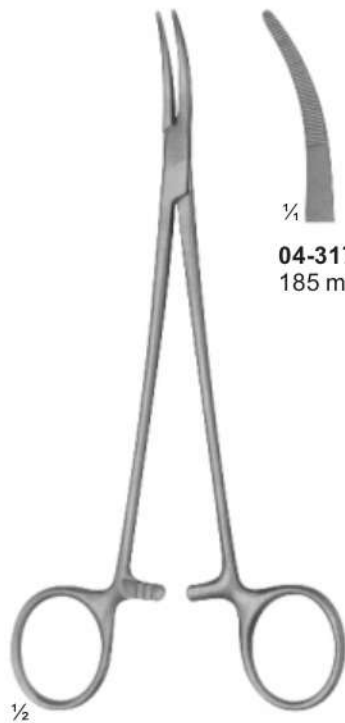

**04-317**  
185 mm



**04-318**



**04-319**

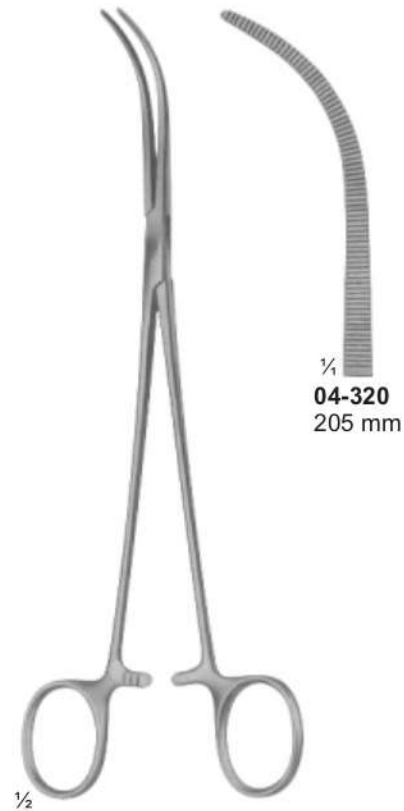

**04-320**  
205 mm



**04-317**  
NISSEN

**04-318 - 319**  
YASARGIL  
195 mm

**04-320**  
OVERHOLT-MIXTER

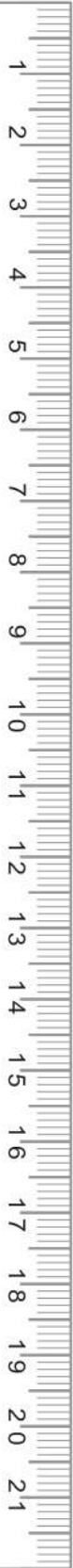

1/2

**04-321 - 332**  
OVERHOLT-GEISSENDOERFER

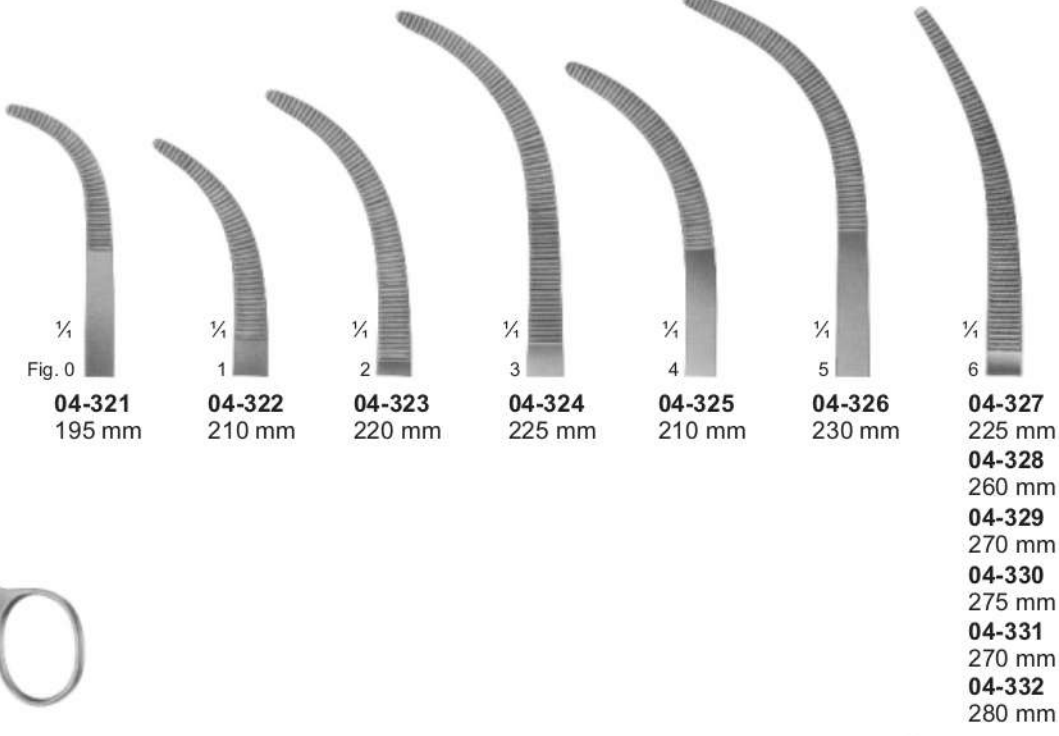

1/2

**04-333 - 340**  
OVERHOLT  
fine pattern

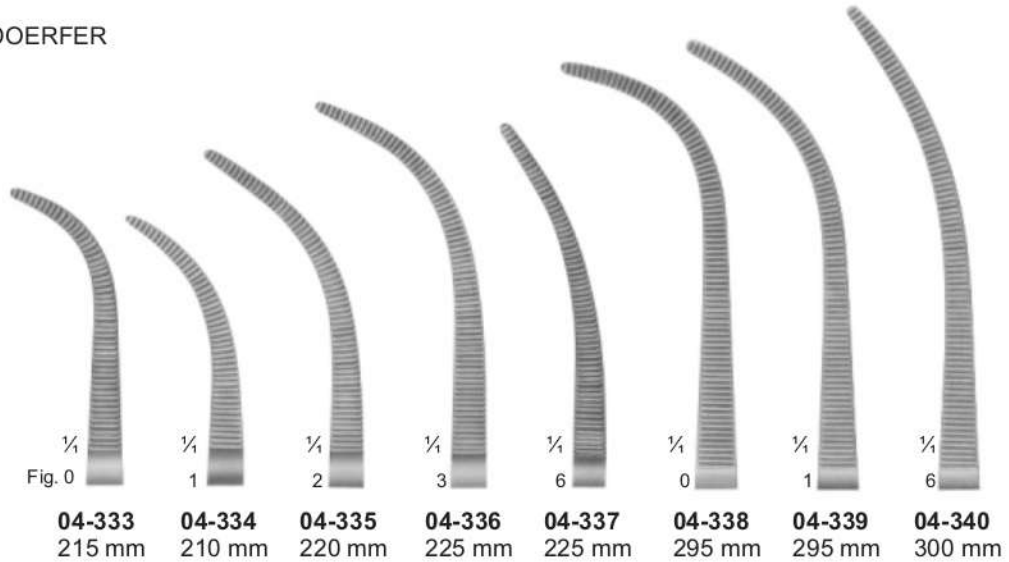

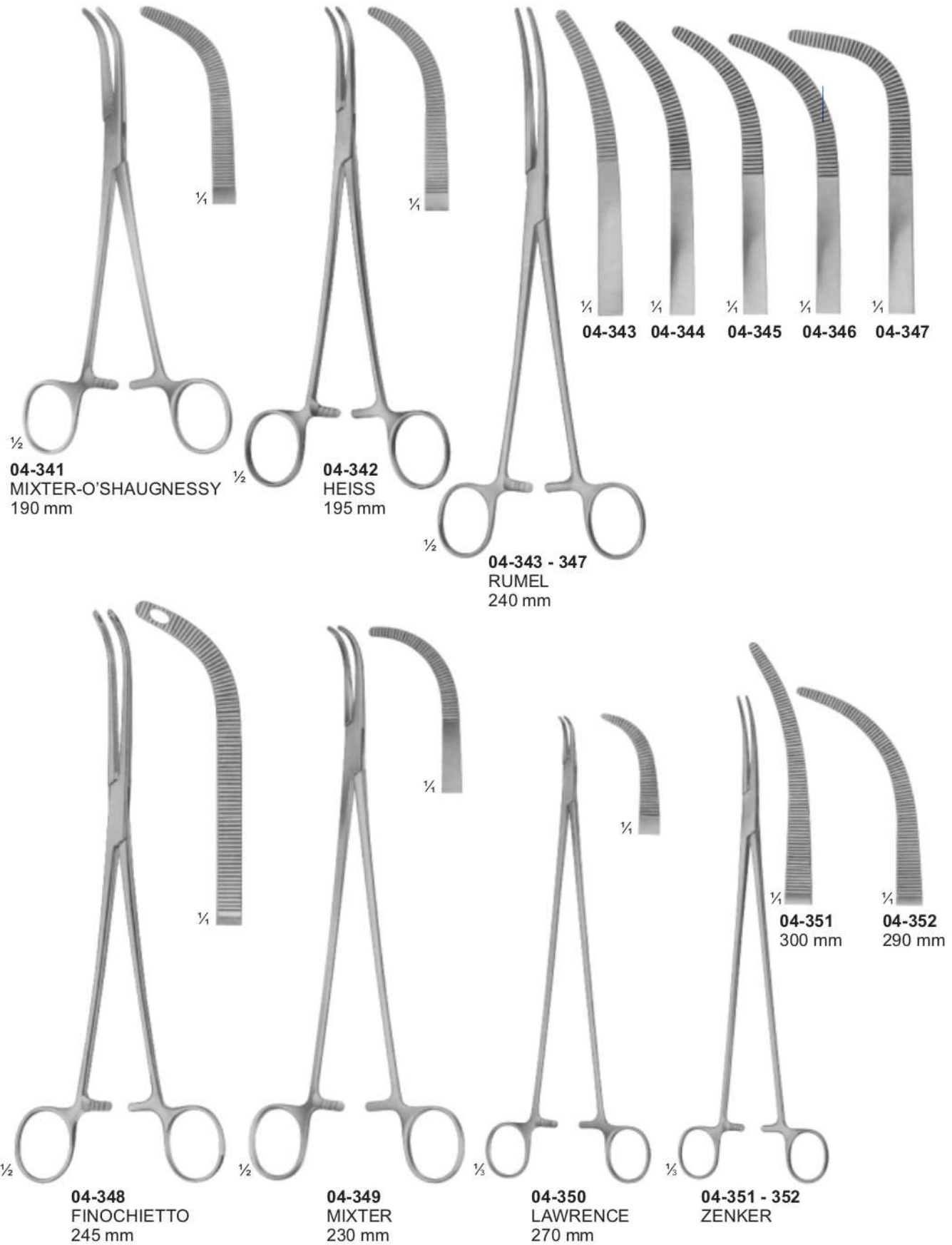

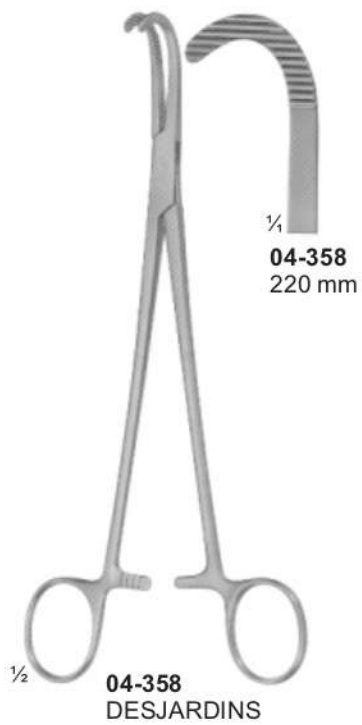



Peritoneum Forceps  
Peritoneum Zange  
Peritoneo Pinzas

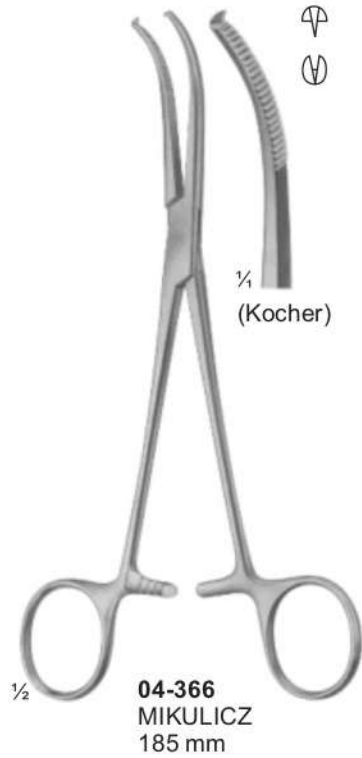
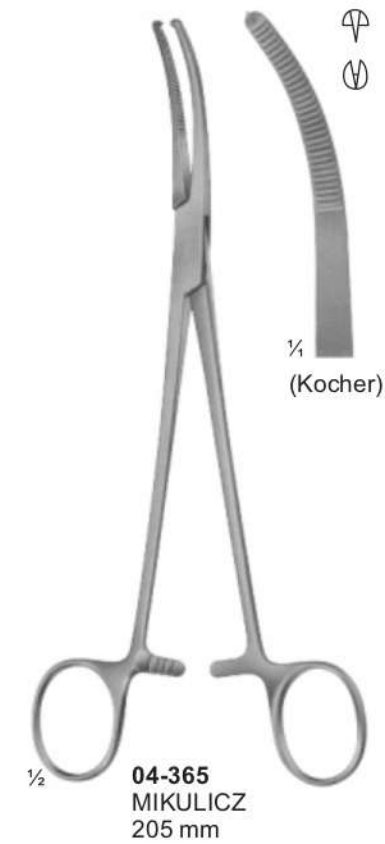
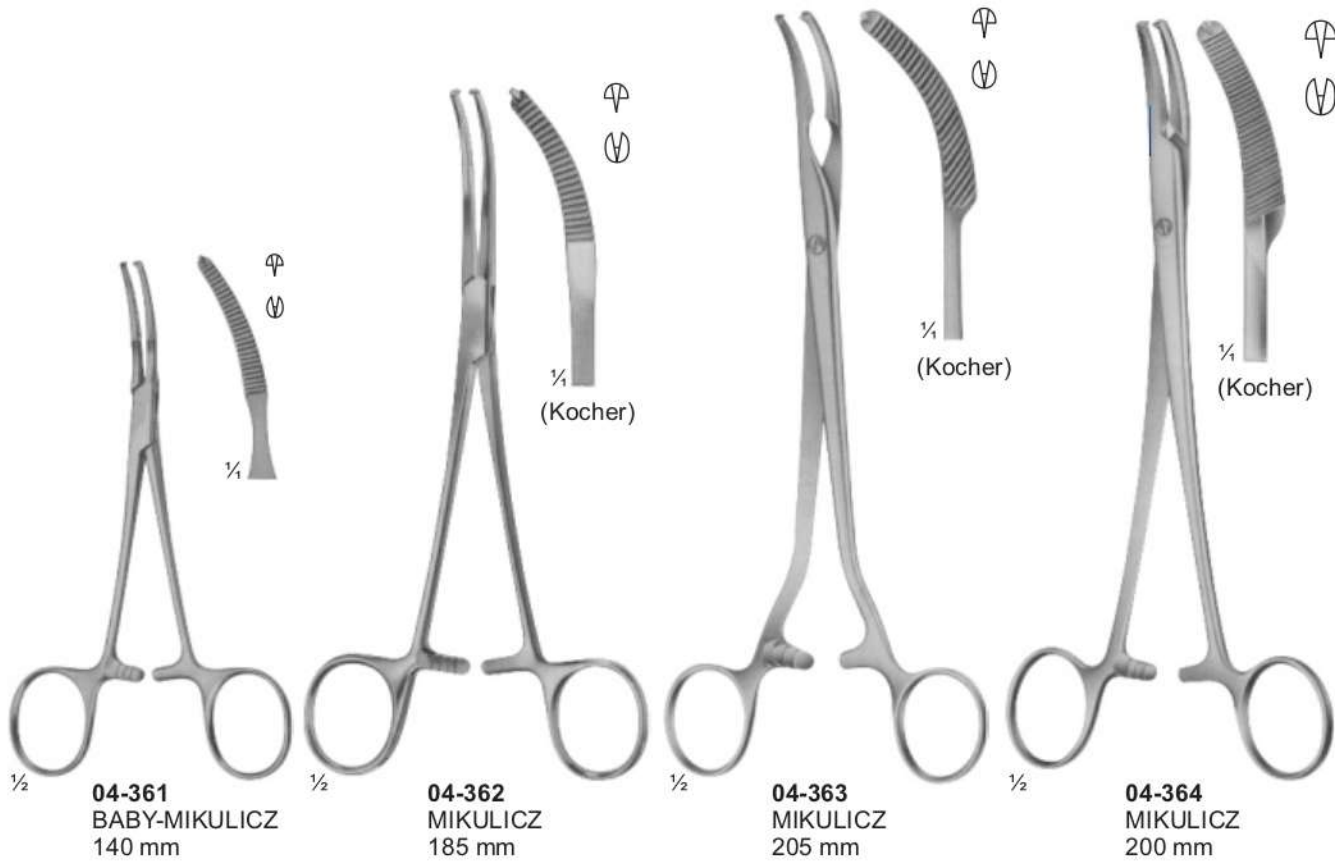



**04-369**  
210 mm  
(Kocher)

**04-370**  
205 mm  
(Kocher)

**04-369 - 370**  
PHANEUF



**04-371**  
205 mm

**04-372**  
245 mm

**04-371 - 372**  
HEANEY modif.



**04-373**  
195 mm

**04-373**  
HEANEY

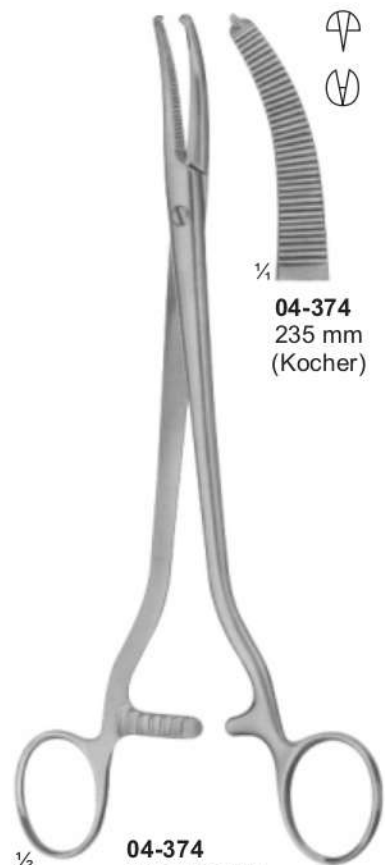

**04-374**  
235 mm  
(Kocher)

**04-374**  
WERTHEIM

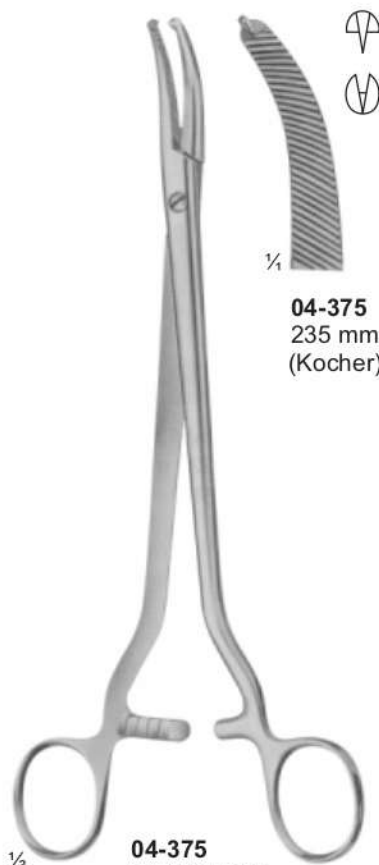

**04-375**  
235 mm  
(Kocher)

**04-375**  
WERTHEIM

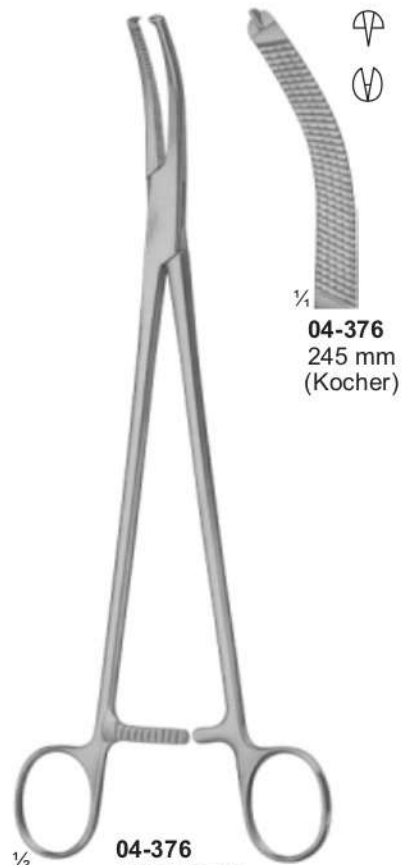

**04-376**  
245 mm  
(Kocher)

**04-376**  
WERTHEIM



**Hysterectomy Forceps And Vaginal Clamps**  
Hysterektomie Pinzetten Und Klemmen Vaginal  
Pinzas De La Histerectomía Vaginal Y Abrazaderas

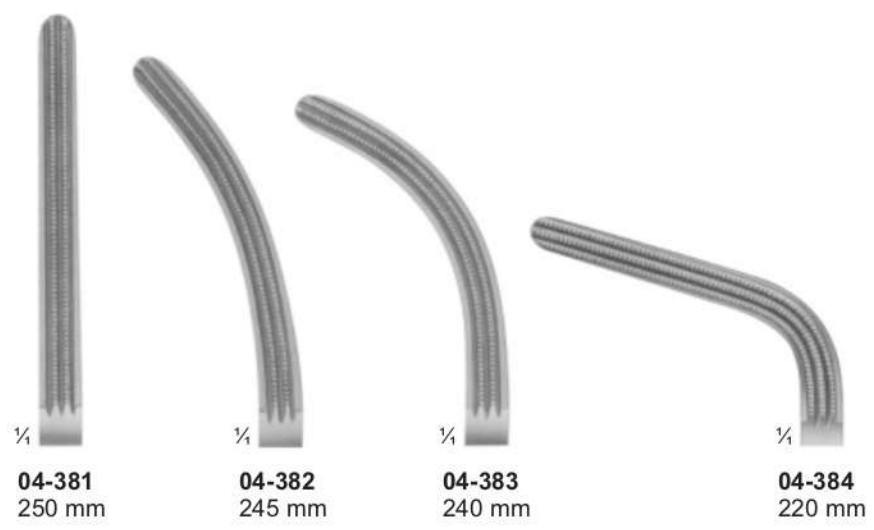
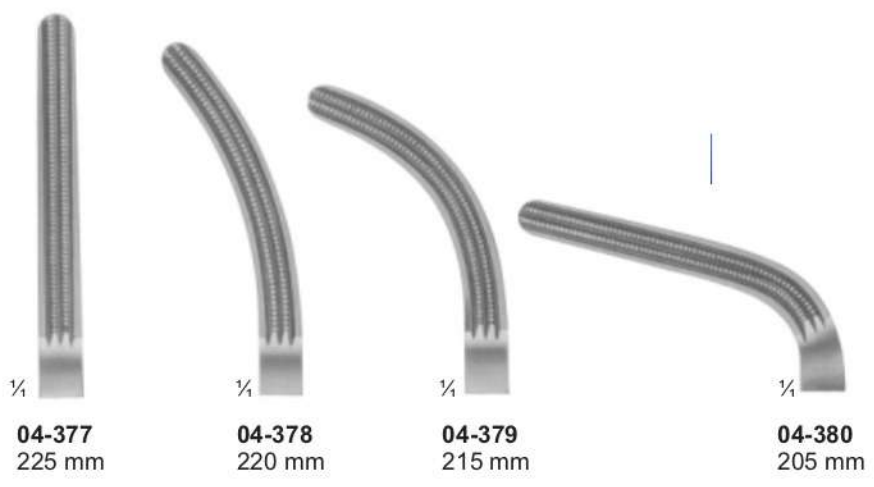



MATU BROTHERS  
SURGICAL

Hysterectomy Forceps And Vaginal Clamps And Compression Forceps  
Hysterektomie Pinzetten Und Klemmen Und Vaginal Kompressionszange  
Pinzas De La Histerectomía Vaginal Y Abrazaderas Y Pinzas De Compresión



1/2 **04-385**  
WERTHEIM  
Hysterectomy Forceps  
255 mm

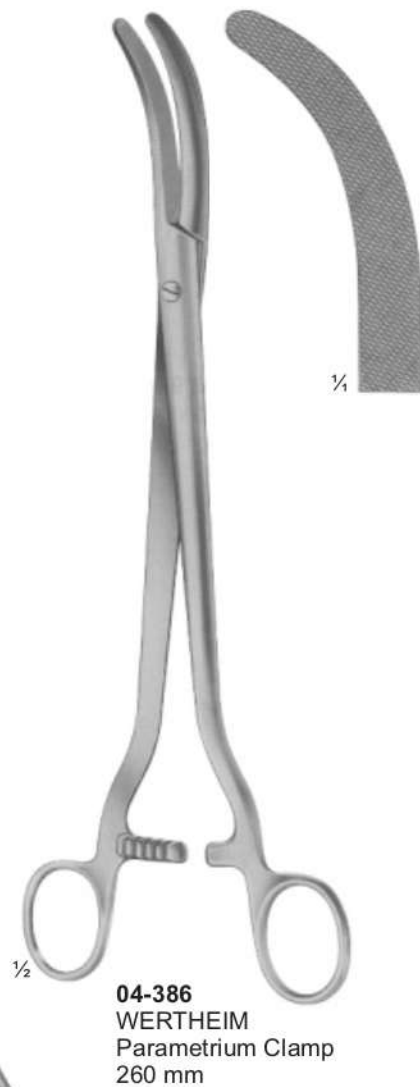

1/2 **04-386**  
WERTHEIM  
Parametrium Clamp  
260 mm

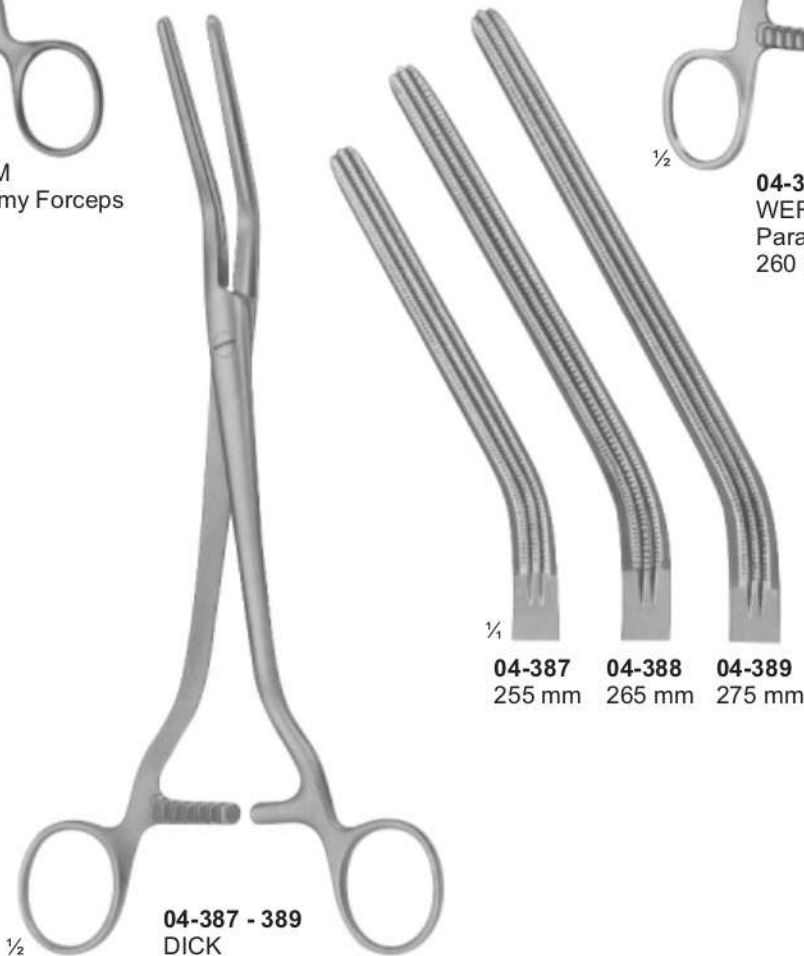

1/2 **04-387 - 389**  
DICK

1/4 **04-387** 255 mm **04-388** 265 mm **04-389** 275 mm





**Hysterectomy Forceps And Vaginal Clamps And Compression Forceps**  
Hysterektomie Pinzetten Und Klemmen Und Vaginal Kompressionszange  
Pinzas De La Histerectomía Vaginal Y Abrazaderas Y Pinzas De Compresión

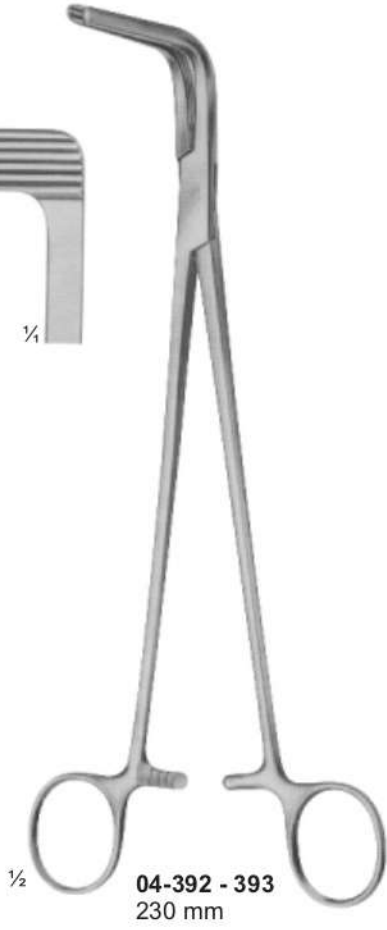
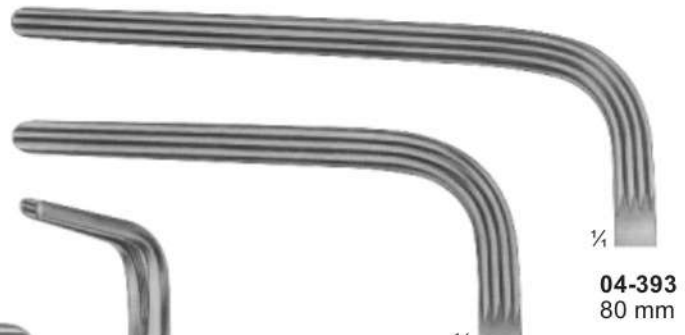

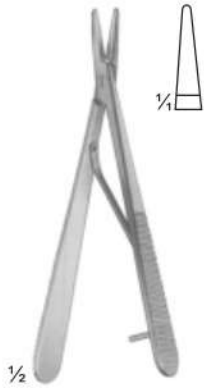
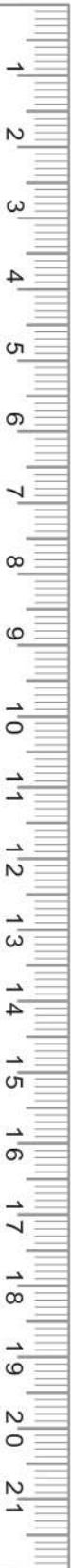

**04-394**  
**ROHRSCHEIDER**  
 With copper inserts  
 100 mm



**04-395**  
**KALT**  
 With catch  
 135 mm



**04-396**  
**ARRUGA**  
 With catch  
 135 mm



**04-397 - 398**  
**CASTROVIEJO**  
 With catch  
 145 mm



**04-399 - 400**  
**CASTROVIEJO**  
 With Catch  
 160 mm



**04-401 - 402**  
 Without catch  
 185 mm



**04-402**



**04-403 - 404**  
**JACOBSON**  
 185 mm



**04-404**  
 With catch



**04-405**  
 Without catch  
 195 mm



**04-406 - 407**  
**YASARGIL**  
 With catch  
 200 mm

**Micro Needle Holders With Round Handles**  
**Mikronadelhalter Rundgriff**  
**Titulares Micro Agujas Con Manijas Redondas**



**MATU BROTHERS  
 SURGICAL**



**04-408**  
115 mm



**04-409**  
135 mm

**04-408 - 409**  
BARRAQUER  
Without catch



**04-410**



**04-411**

**04-410 - 411**  
BARRAQUER  
Without catch  
120 mm



**04-412**



**04-413**

**04-412 - 413**  
BARRAQUER  
With catch  
120 mm



**04-414**



**04-415**

**04-414 - 415**  
BARRAQUER  
With Catch  
150 mm

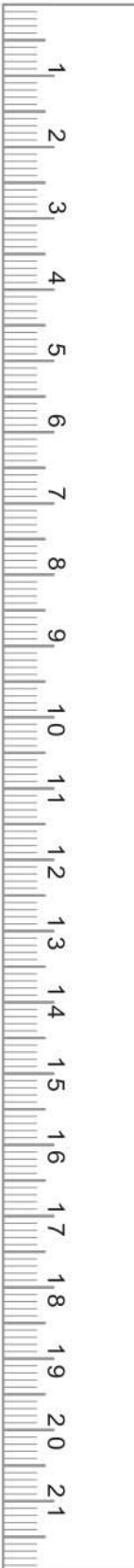

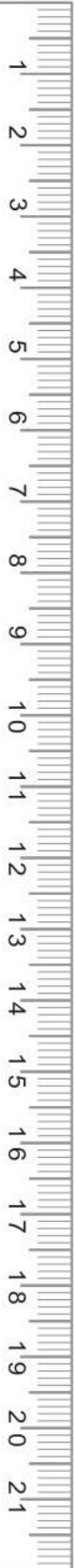

**04-416 04-417**

**04-416 - 417**  
**YASARGIL**  
 200 mm



**04-418 04-419**

**04-418 - 419**  
**YASARGIL**  
 225 mm



**04-420**  
**YASARGIL**  
 245 mm

**Needle Holders**  
Nadelhalter  
Porta Agujas

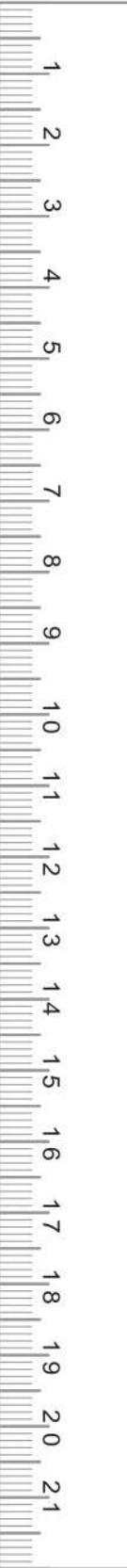
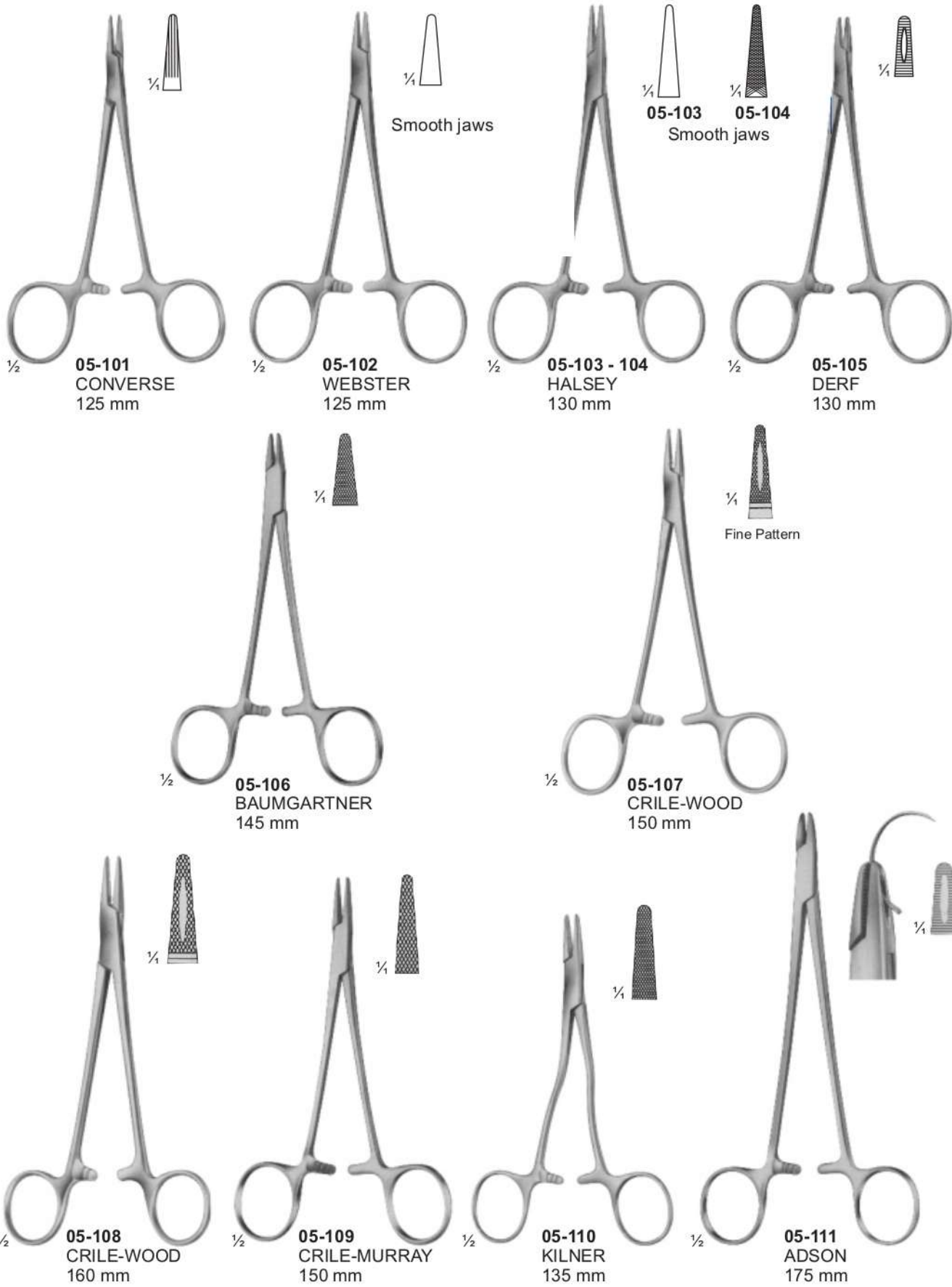

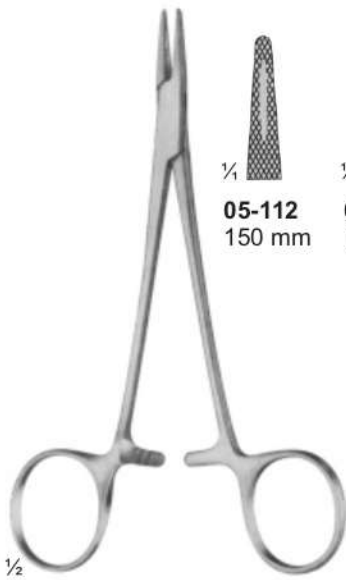
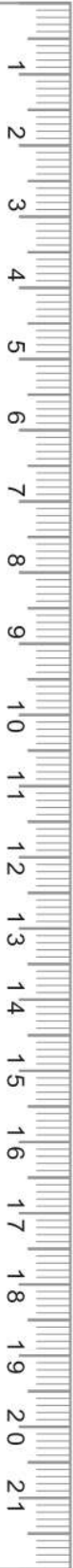

**05-112**  
150 mm

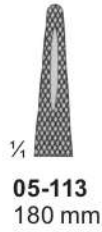

**05-113**  
180 mm

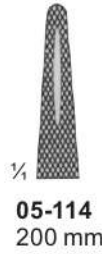

**05-114**  
200 mm

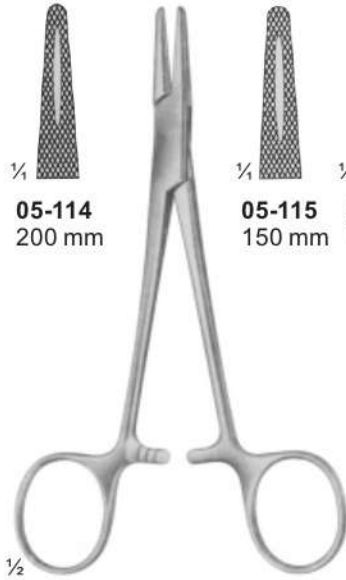

**05-115**  
150 mm

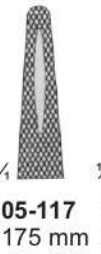

**05-117**  
175 mm

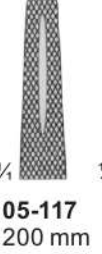

**05-117**  
200 mm

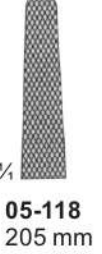

**05-118**  
205 mm

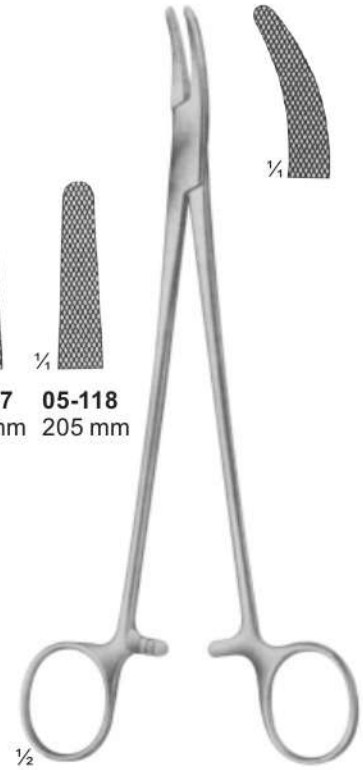

**05-119**  
HEANEY (HEGAR)  
200 mm

**05-112 - 114**  
MAYO-HEGAR  
Medium fine patterns

**05-115 - 118**  
HEGAR  
Heavy Patterns

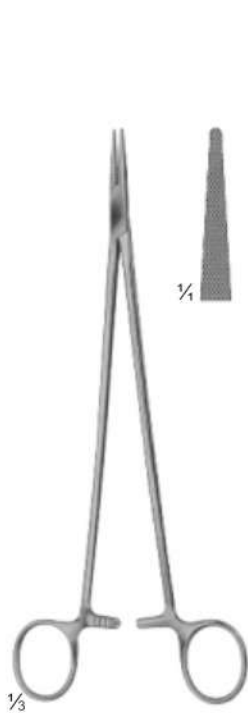

**05-120**  
JAMESON  
230 mm



**05-121**  
WANGENSTEEN  
275 mm



**05-122**  
MASSON  
265 mm

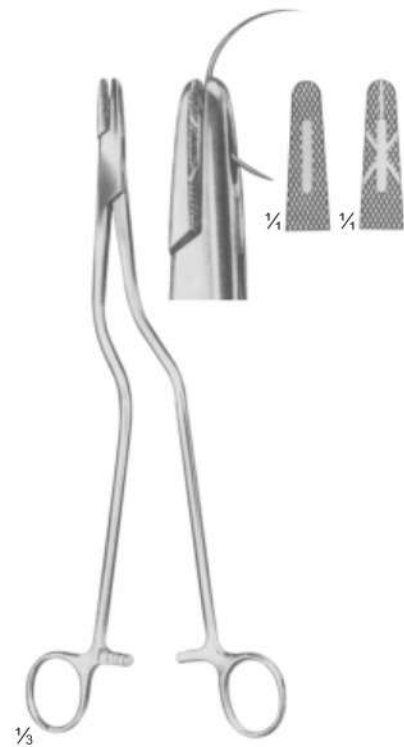

**05-123**  
MASSON-LUETHY  
255 mm

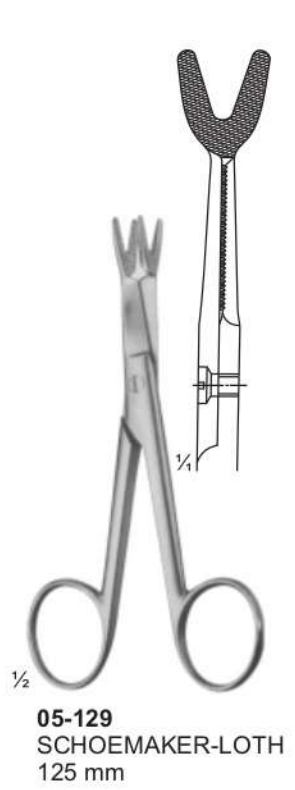
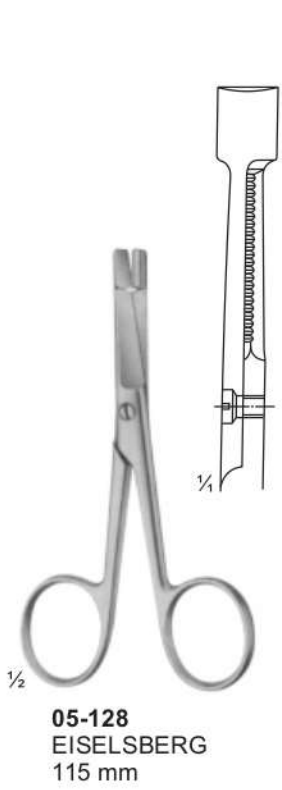
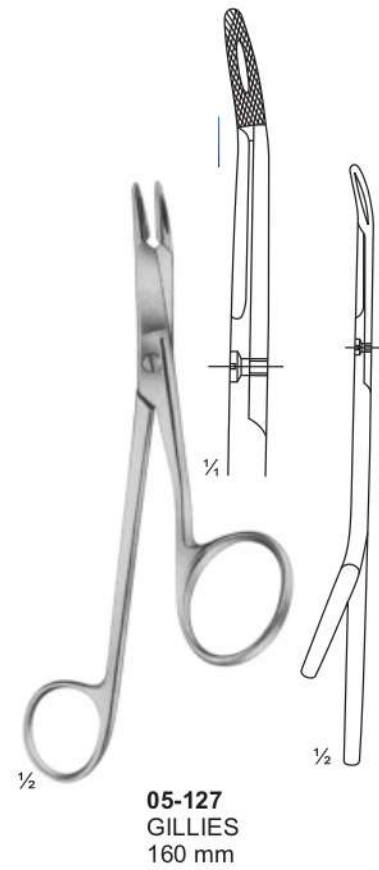
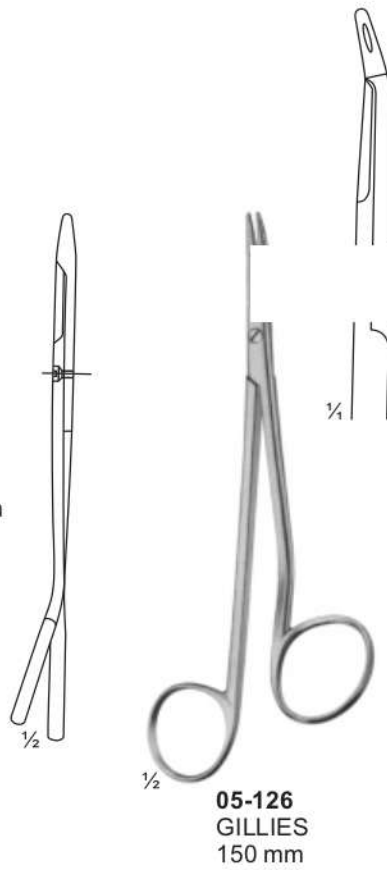
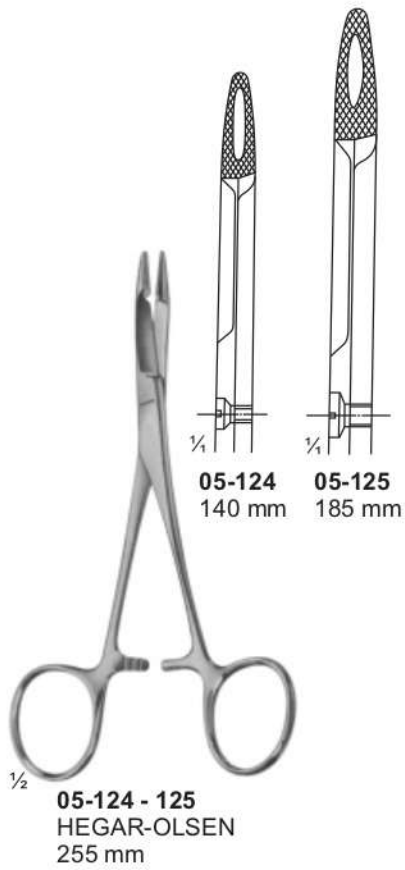



**05-132** 140 mm  
**05-133** 170 mm  
**05-134** 200 mm

**05-132 - 134  
MATHIEU**

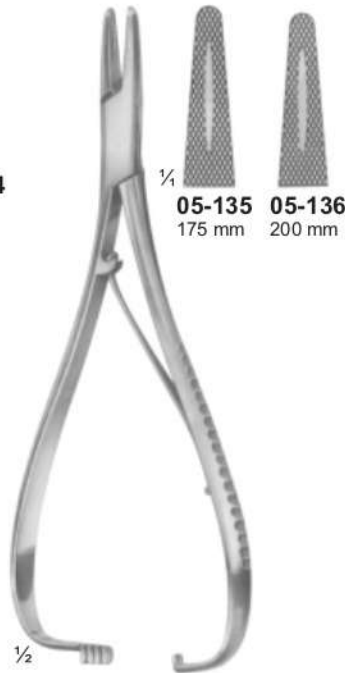

**05-135** 175 mm  
**05-136** 200 mm

**05-135 - 136  
MATHIEU-STILLE  
Very heavy models**



**05-137  
BOYNTON  
125 mm**



**05-138  
EISELSBERG-MATHIEU  
For palate suture  
195 mm**



**05-139  
MATHIEU-KOCHER**



**05-140  
BOYNTON  
125 mm**



**05-141  
MILLIN  
Ligature holding forceps  
245 mm**





**Suture Instruments - Reverdin Needles**  
Naht-instrumente - Reverdin Needles  
- Agujas De Sutura Instrumentos Reverdin

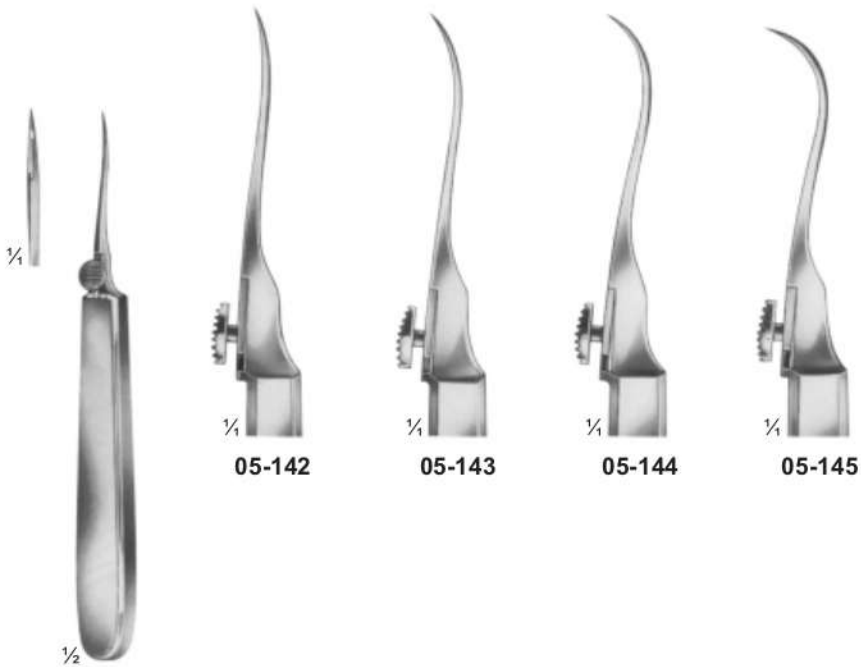

**05-142 - 145**  
REVERDIN  
140 mm



**05-146 - 149**  
REVERDIN  
195 mm

**05-150 - 154**  
REVERDIN  
220 mm



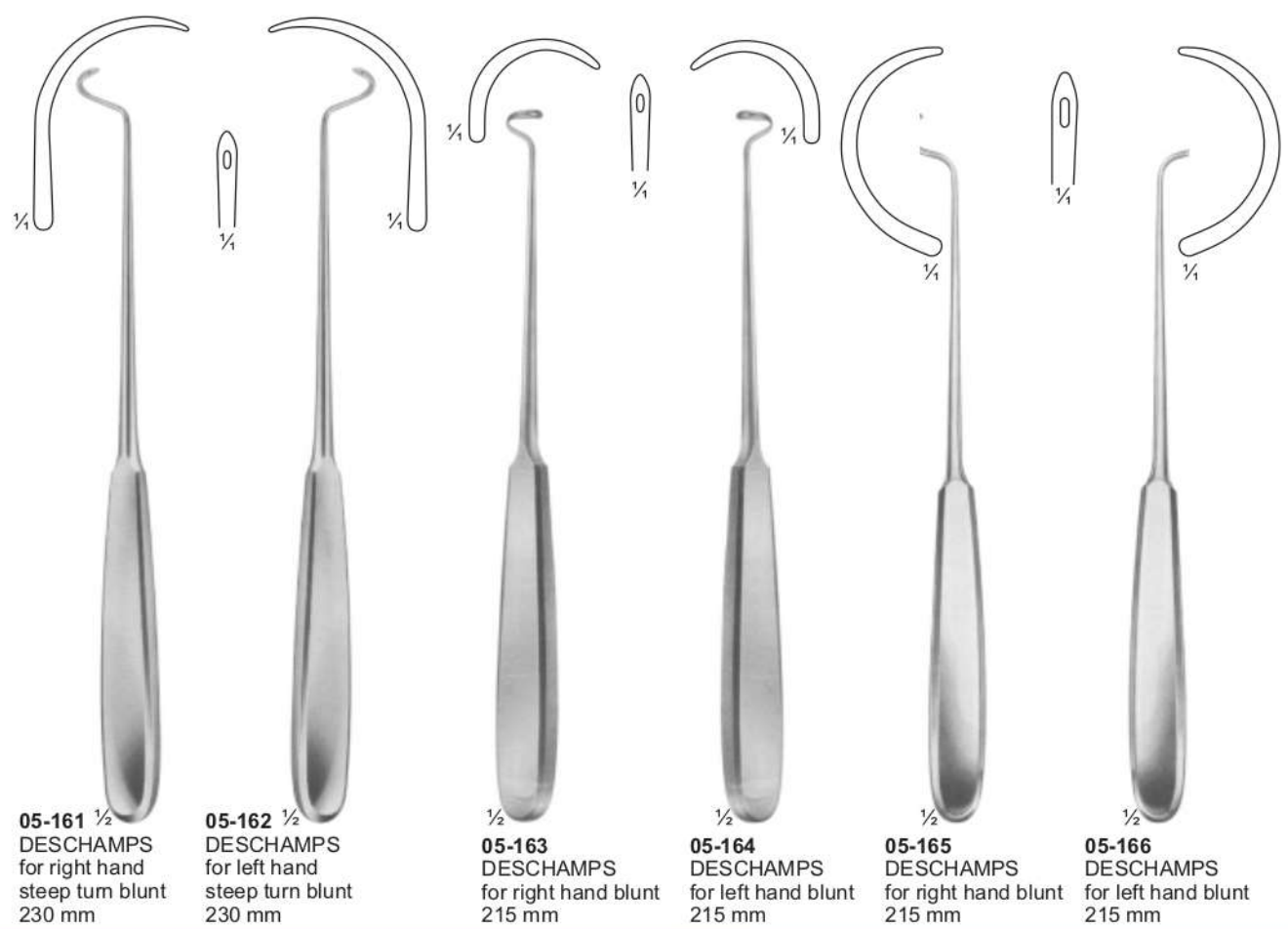
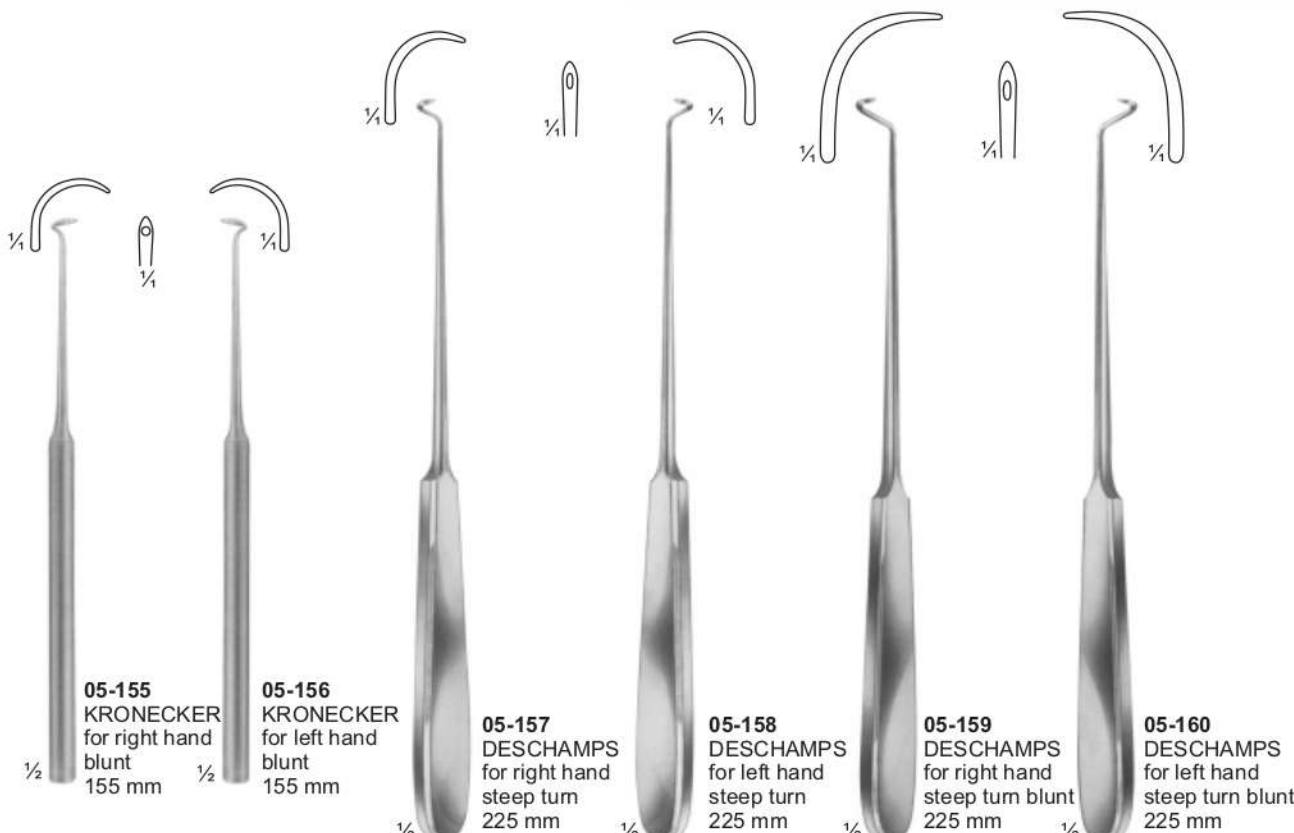



Suture Instruments - Ligature Needles  
Naht-instrumente - Ligature Needles  
Instrumentos De Sutura Ligadura - Agujas

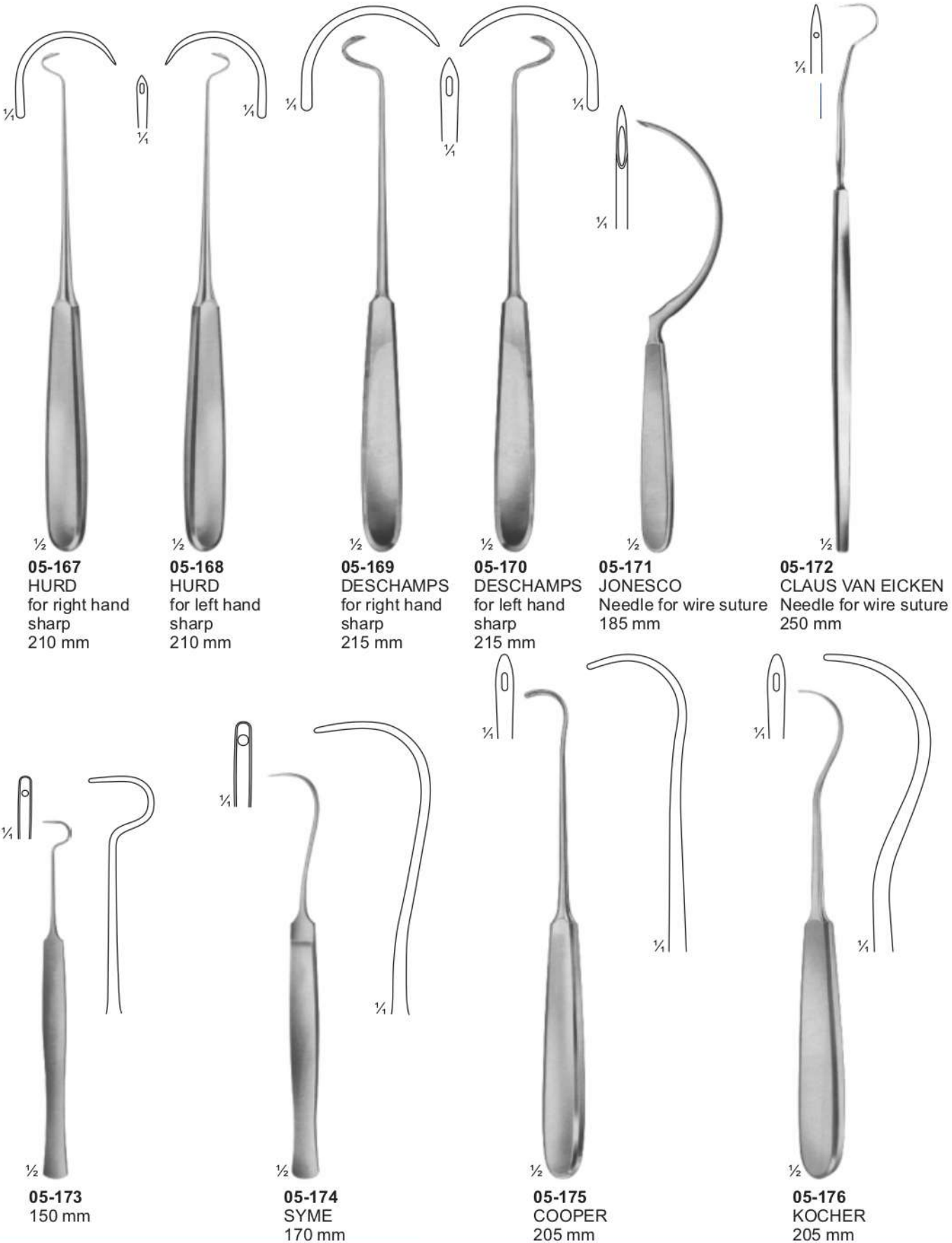

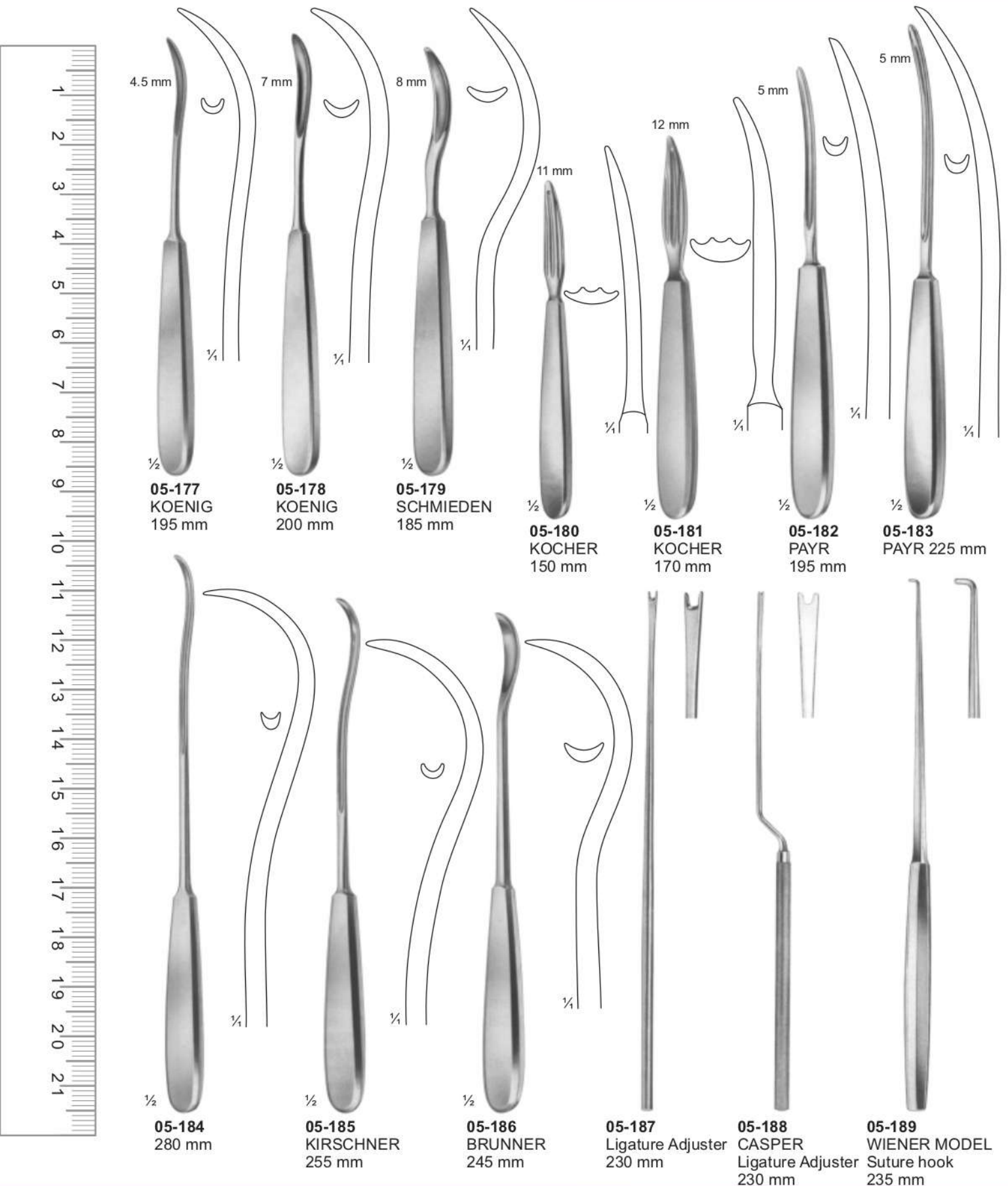

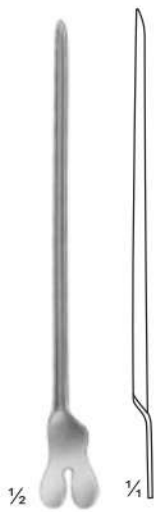

**05-190** 130 mm  
**05-191** 145 mm  
**05-192** 160 mm  
Directors

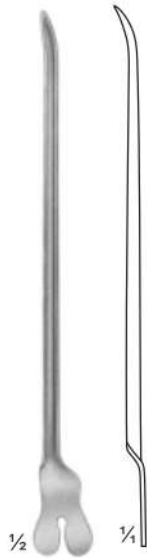

**05-193**  
**DOYEN**  
145 mm  
Directors



**05-194**  
**NELATON**  
160 mm  
Directors

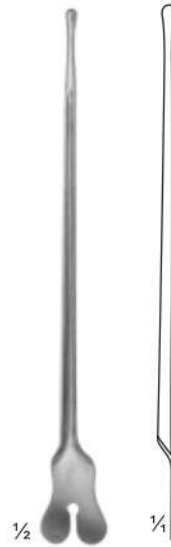

**05-195**  
Director with tip  
Diam. Of tip 3,3 mm  
140 mm

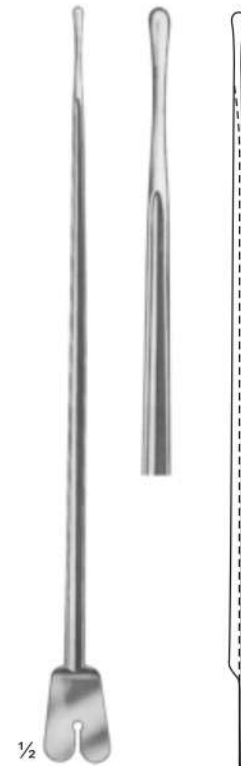

**05-196**  
**BRODIE**  
Director with tip,  
Diam. Of tip 3,5 mm  
200 mm



**05-197** 2,5 mm  
**05-198** 2,5 mm  
**05-199** 3,0 mm



**05-197** 145 mm  
**05-198** 160 mm  
**05-199** 200 mm  
Probes with eye

1,5 mm



**05-200**  
Myrtle leaf probe  
145 mm

2,0 mm



**05-201** 130 mm  
**05-202** 145 mm  
**05-203** 160 mm  
**05-204** 180 mm  
**05-205** 200 mm



**05-206**  
Probes



**05-207**  
Double ended probe,  
malleable, diam. of tips  
3 mm with hole  
190 mm



**05-208**  
Double ended probes,  
tin, malleable,  
diam. of tips  
3,5 mm with hole  
250 mm, 300 mm



**05-209**  
Double ended probes,  
tin, malleable,  
diam. of tips 4 mm  
400 mm



$\frac{1}{3}$   $\varnothing$  tip  
**05-210** 1,5 mm  
**05-211** 2,0 mm  
**05-212** 2,5 mm  
300 mm



**05-213**  
 STACKE  
 100 mm



**05-214**  
 KILLIAN  
 165 mm



**05-215**  
 160 mm



**05-216**  
 SEIFFERT  
 180 mm



**05-217**  
 BOWMAN  
 130 mm

German Silver



**05-218**  
 SPATULA  
 145 mm



**05-219**  
 SPATULA  
 145 mm



**05-220**  
 Modell PICCOLO  
 Round Serrated  
 110 mm



**05-221**  
 Modell PICCOLO  
 Triangular Serrated end  
 110 mm



**05-222**  
 FARRELL  
 Round Serrated end  
 110 mm



**05-223**  
 LATHBURY-FARREL  
 Triangular Serrated end  
 110 mm



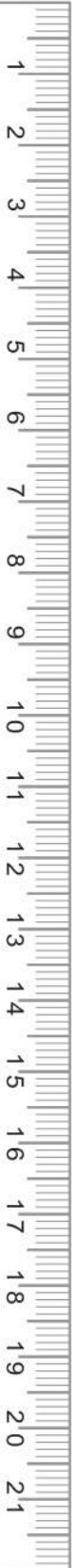

**05-224**  
BUCK  
Rough, spiral end  
120 mm



**05-225**  
Triangular  
serrated end  
140 mm



**05-226**  
Rough, spiral end  
140 mm



**05-227**  
Rough, spiral end  
140 mm



**05-228**  
Rough, spiral end  
140 mm



**05-229**  
FARRELL  
Round,  
serrated end  
140 mm



**05-230**  
LATHBURY-FARRELL  
Triangular,  
serrated end  
140 mm



**05-231**  
FARRELL  
Rough,  
spiral end  
160 mm



**05-232**  
LATHBURY-FARRELL  
Triangular,  
serrated end  
160 mm



**05-233**  
Triangular,  
serrated end  
160 mm



**05-234**  
Rough,  
spiral end  
180 mm



**05-235**  
Rough,  
spiral end  
180 mm



**05-236**  
Rough,  
spiral end  
270 mm





**Clip Applying Forceps - Suture Set**  
**Clipanlegezange - Suture Set**  
**Clip La aplicación de fórceps - Juego de sutur**



1/2

**05-237**  
**MICHEL**  
125 mm



1/2

**05-238**  
**HEGENBARTH**  
120 mm



1/2

**05-239**  
**WACHENFELDT**  
120 mm



1/2

**05-240**  
**WACHENFELDT**  
120 mm

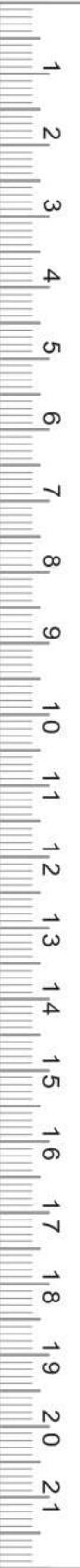

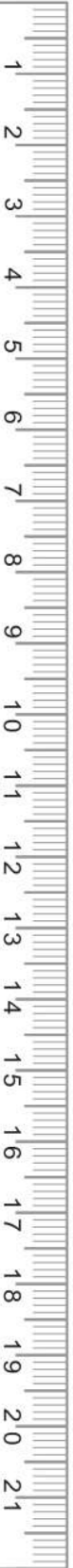

**05-241**  
MICHEL  
125 mm



**05-242**  
MICHEL modif.  
130 mm



**05-243**  
HEATH  
135 mm



**05-244**  
COLLIN  
135 mm



**Nerve - And Vessel Hooks**  
Nerve - Und Hooks Schiff  
Nerviosas - Y El Buque Ganchos

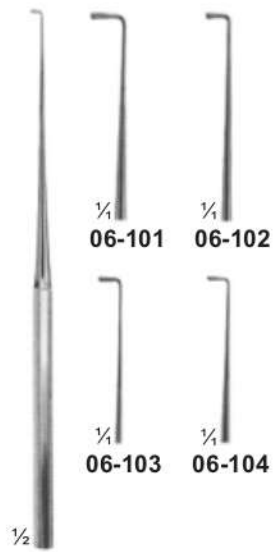

**06-101 - 104**  
WAGENER  
150 mm

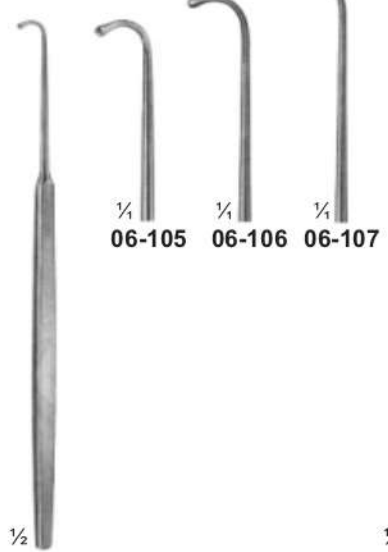

**06-105 - 107**  
GRAEFE  
140 mm



**06-108**  
BROM  
Vein hook  
170 mm



**06-109**  
CRILE  
200 mm

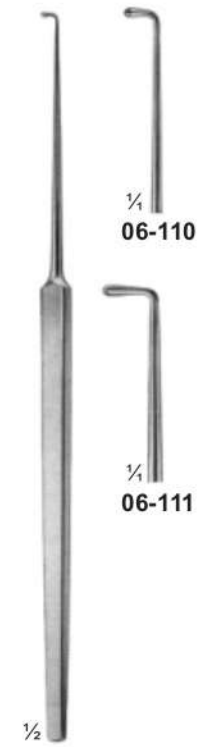

**06-110 - 111**  
CUSHING  
190 mm



Fine Wound Retractors (dura- And Skin Retractors)
Feine Wundhaken (dura-haut-und Retraktoren)
Retractores Bellas Heridas (dura-y Retractores De La Piel)

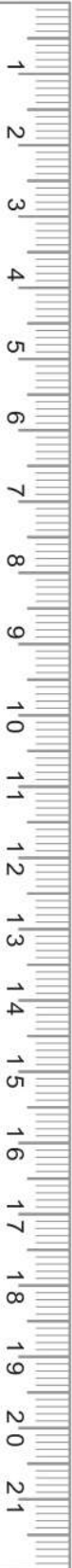

Product catalog showing various surgical retractors (06-112 to 06-135) with their names, types (Sharp/Blunt), and dimensions. Includes illustrations of each tool and a vertical ruler for scale.



Wound - Trachea Retractors  
Wound - Trachea Retraktoren  
Herida - Retractores Tráquea



**06-136** BERGMANN 140 mm  
**06-137** BOSE 165 mm  
**06-138** BOSE 165 mm  
**06-139 - 141** 180 mm

**06-142 - 144** Flexible shaft, sharp 155 mm

**06-145 - 147** Flexible shaft, blunt 155 mm

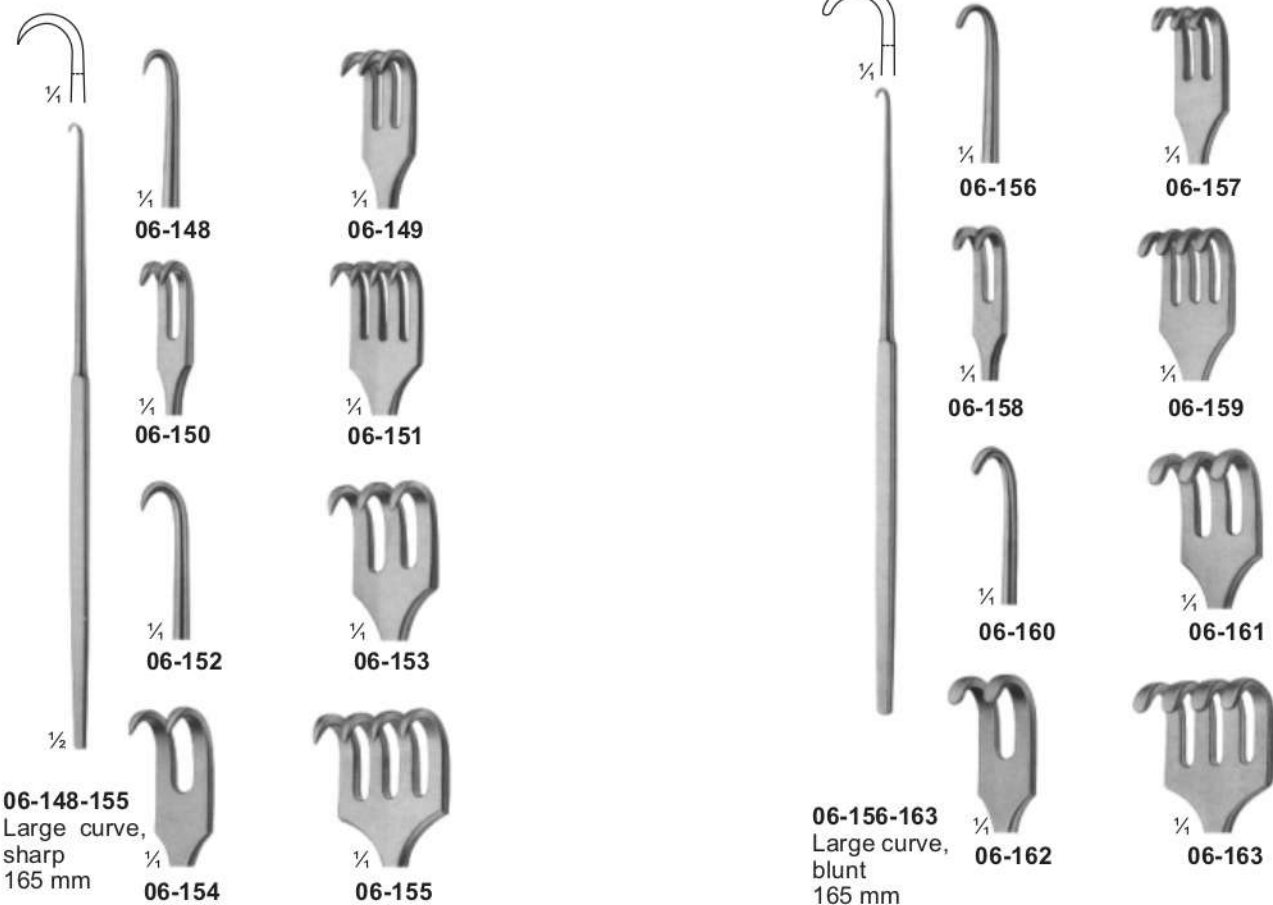

**06-148-155** Large curve, sharp 165 mm

**06-156-163** Large curve, blunt 165 mm



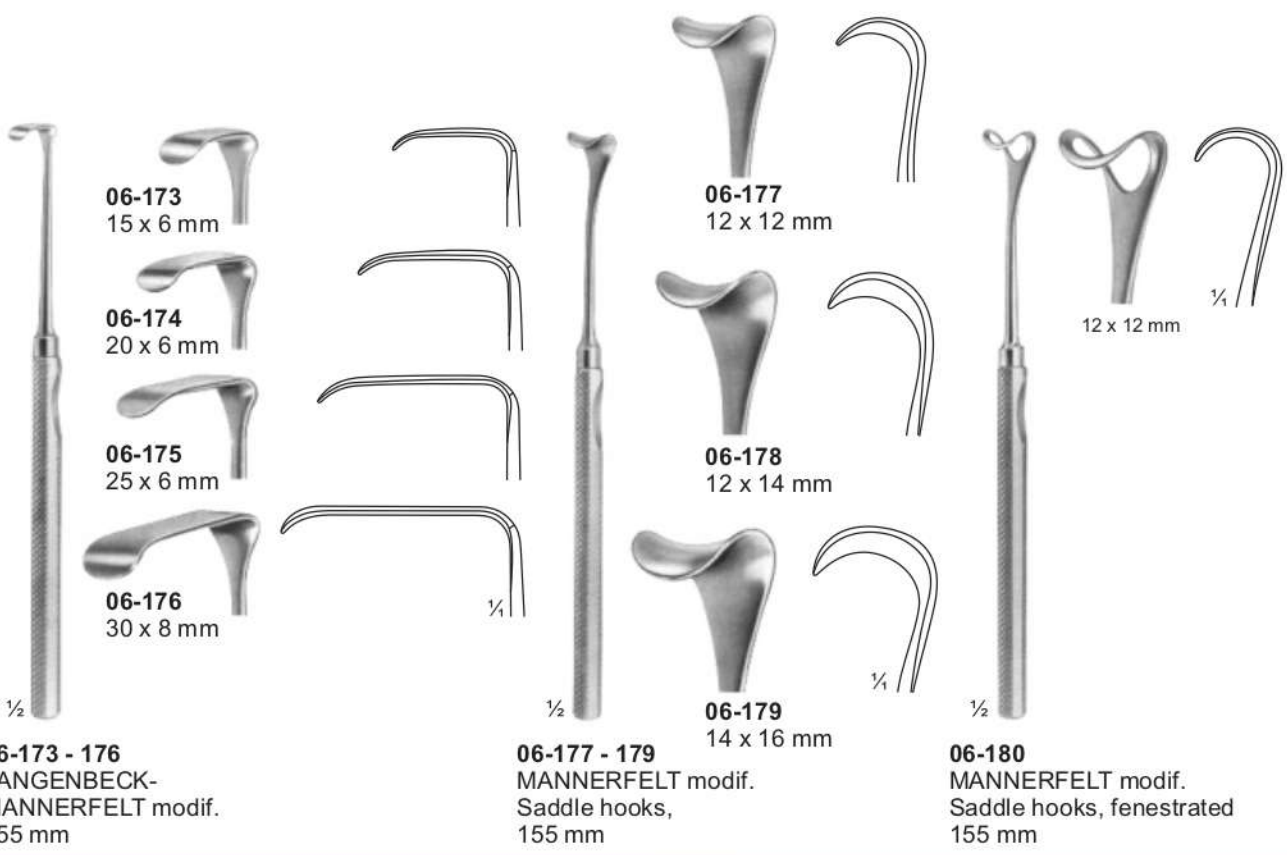
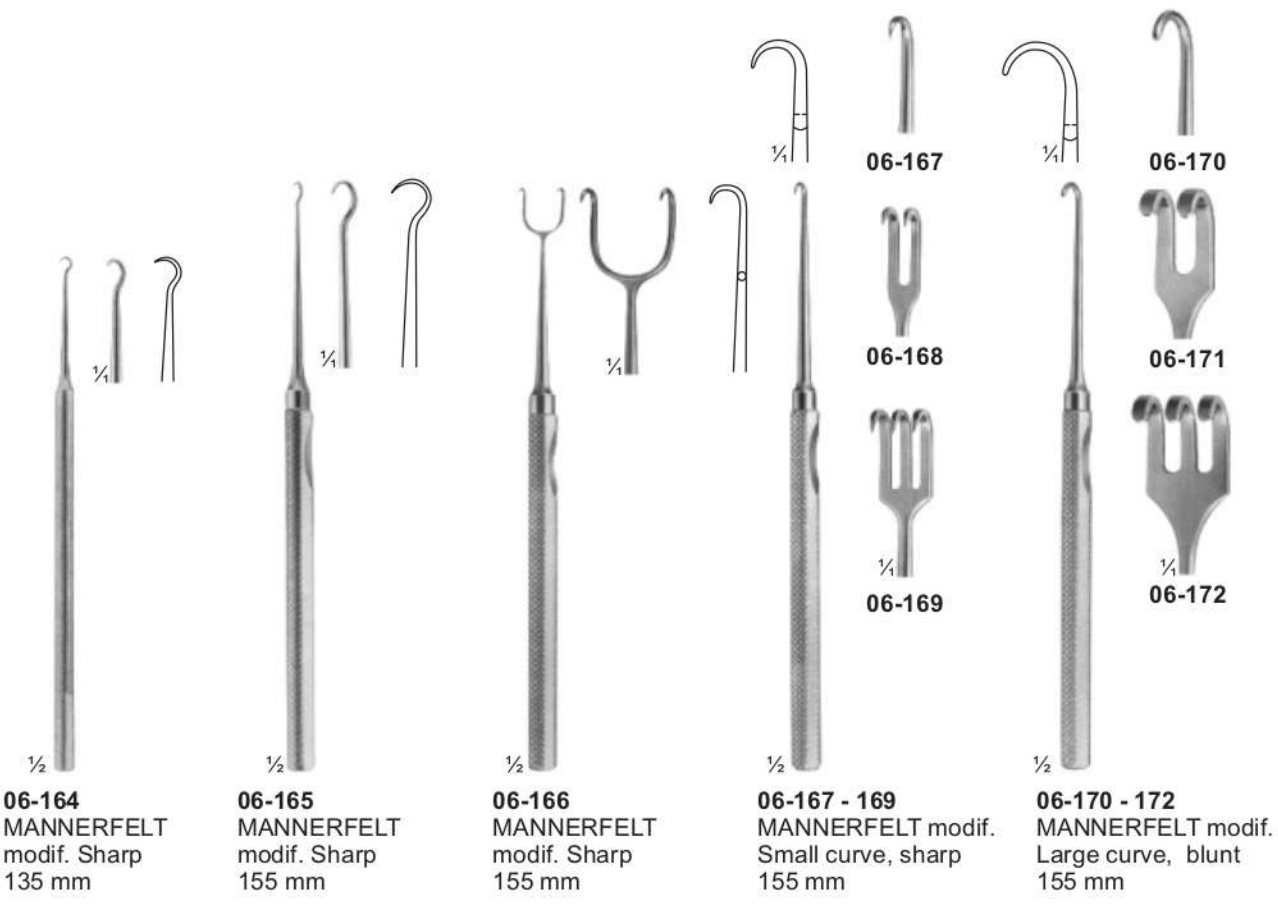
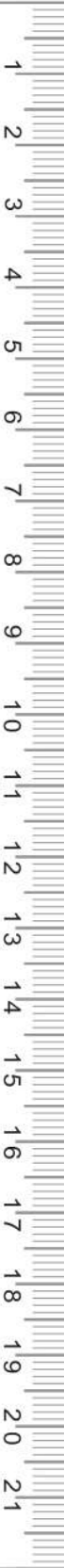

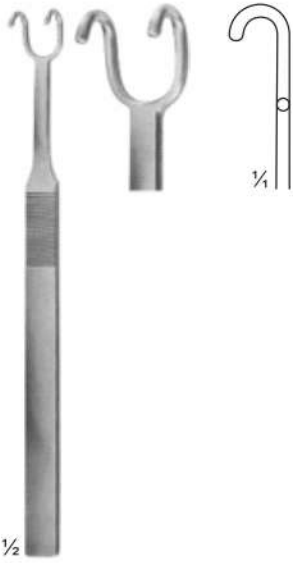

**06-181**  
**FOMON**  
 145 mm



**06-182 - 183**  
 160 mm



**06-184 - 185**  
**LANGENBECK-GREEN**  
 160 mm



**06-186**  
 160 mm



**06-187 - 192**  
**MEYERDING**  
 Fig. A - Fig. F  
 180 mm

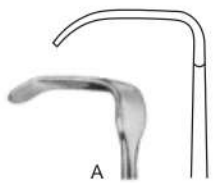

**06-187**  
 18 x 7 mm



**06-188**  
 16 x 5 mm



**06-189**  
 7 x 4 mm



**06-190**  
 5 x 10 mm



**06-191**  
 11 x 4 mm



**06-192**  
 6 x 4 mm

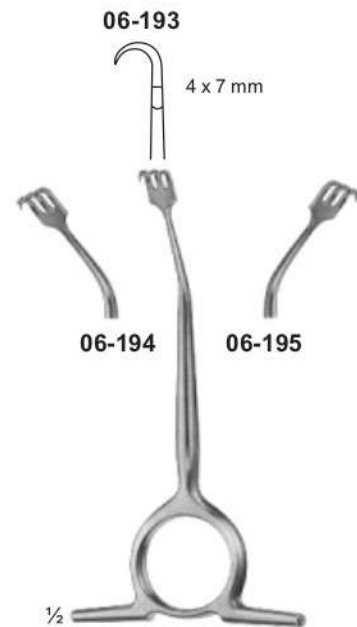

**06-193**  
 4 x 7 mm

**06-194**

**06-195**

**06-193 - 195**  
**WILLIGER**  
 120 mm

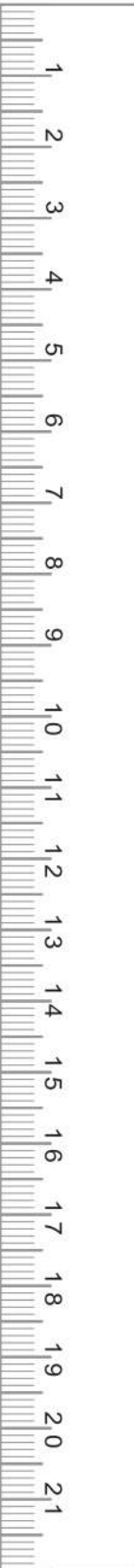

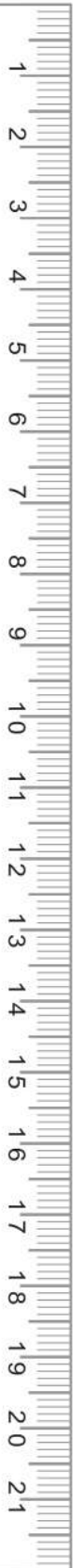

**06-196**  
EMMETT  
Fistula hook  
220 mm

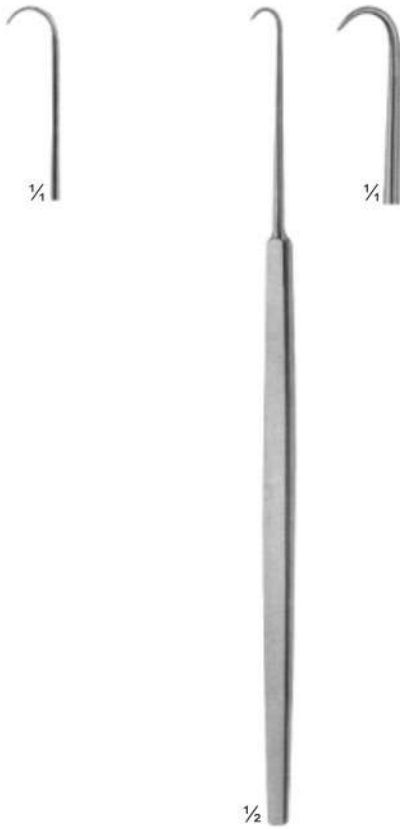

**06-197**  
SIMON  
Fistula hook  
220 mm



**06-198**  
SIMON  
Fistula hook  
220 mm



**06-199**  
LANGE  
Fistula hook  
230 mm



12 x 6 mm

**06-200**

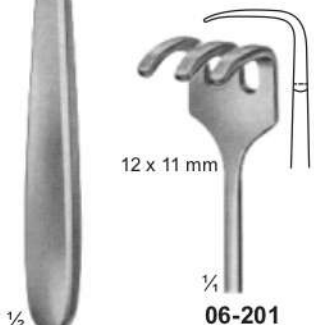

12 x 11 mm

**06-201**

**06-200 - 201**  
Tendon hooks  
175 mm

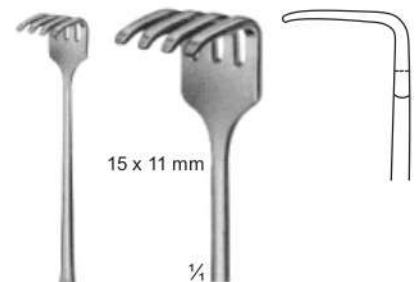

15 x 11 mm

**06-202**

**06-202**  
KLAPP  
Tendon hooks  
175 mm



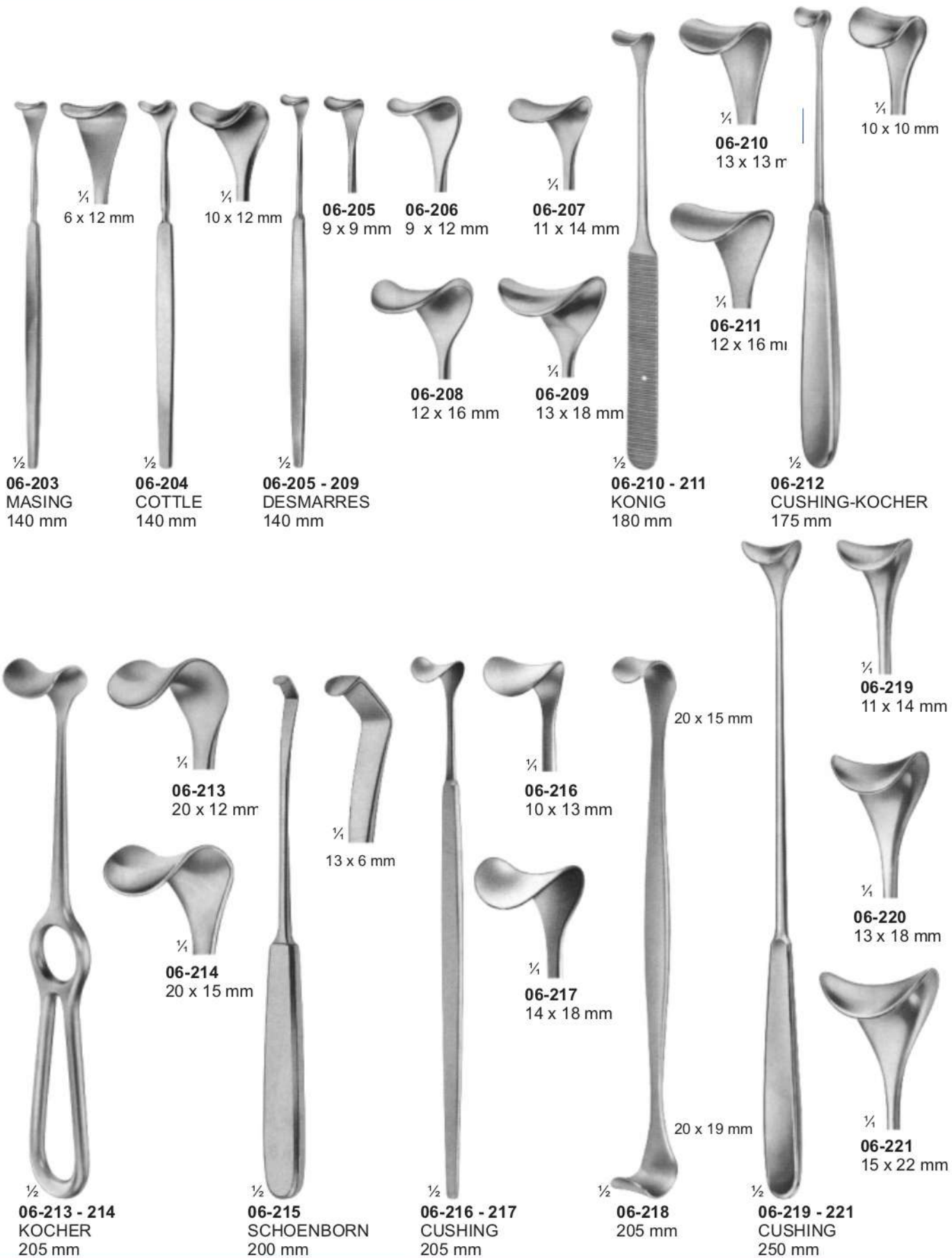

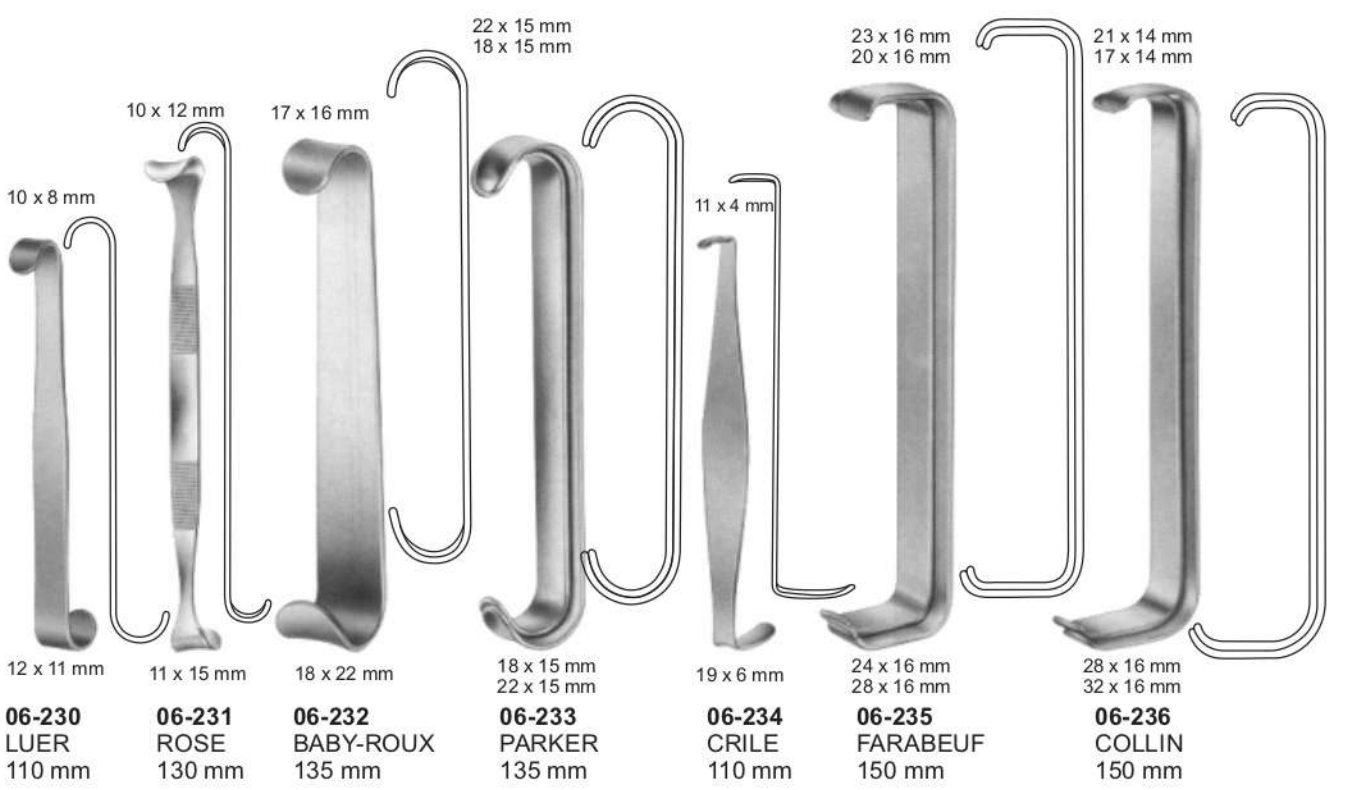
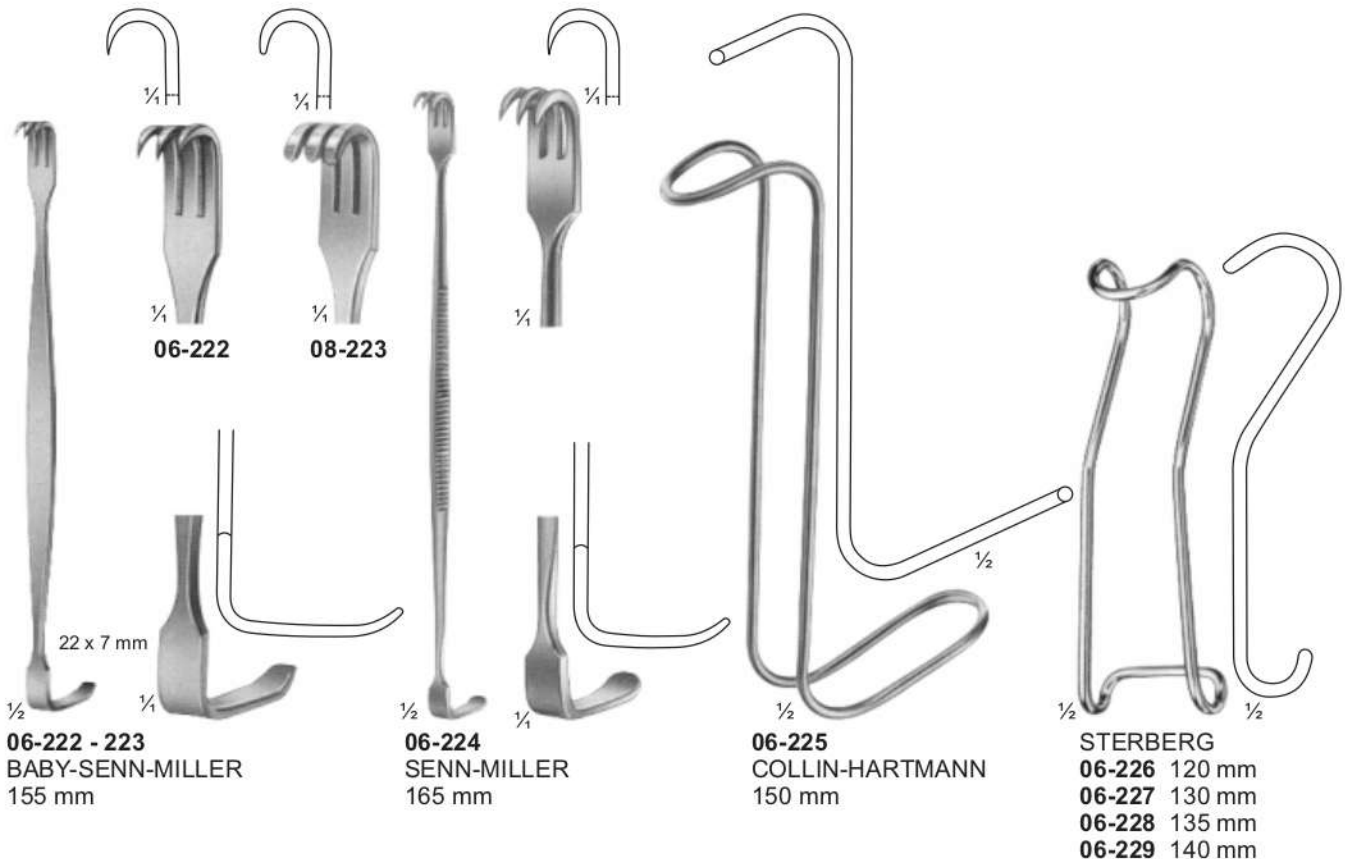

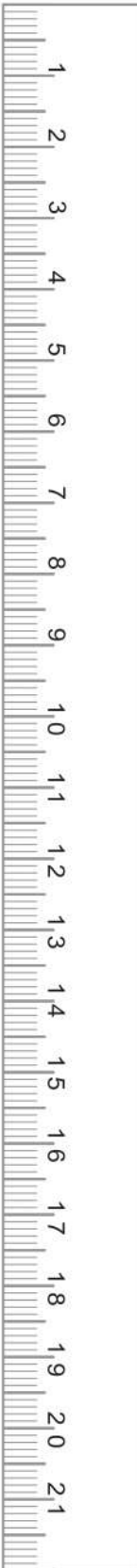
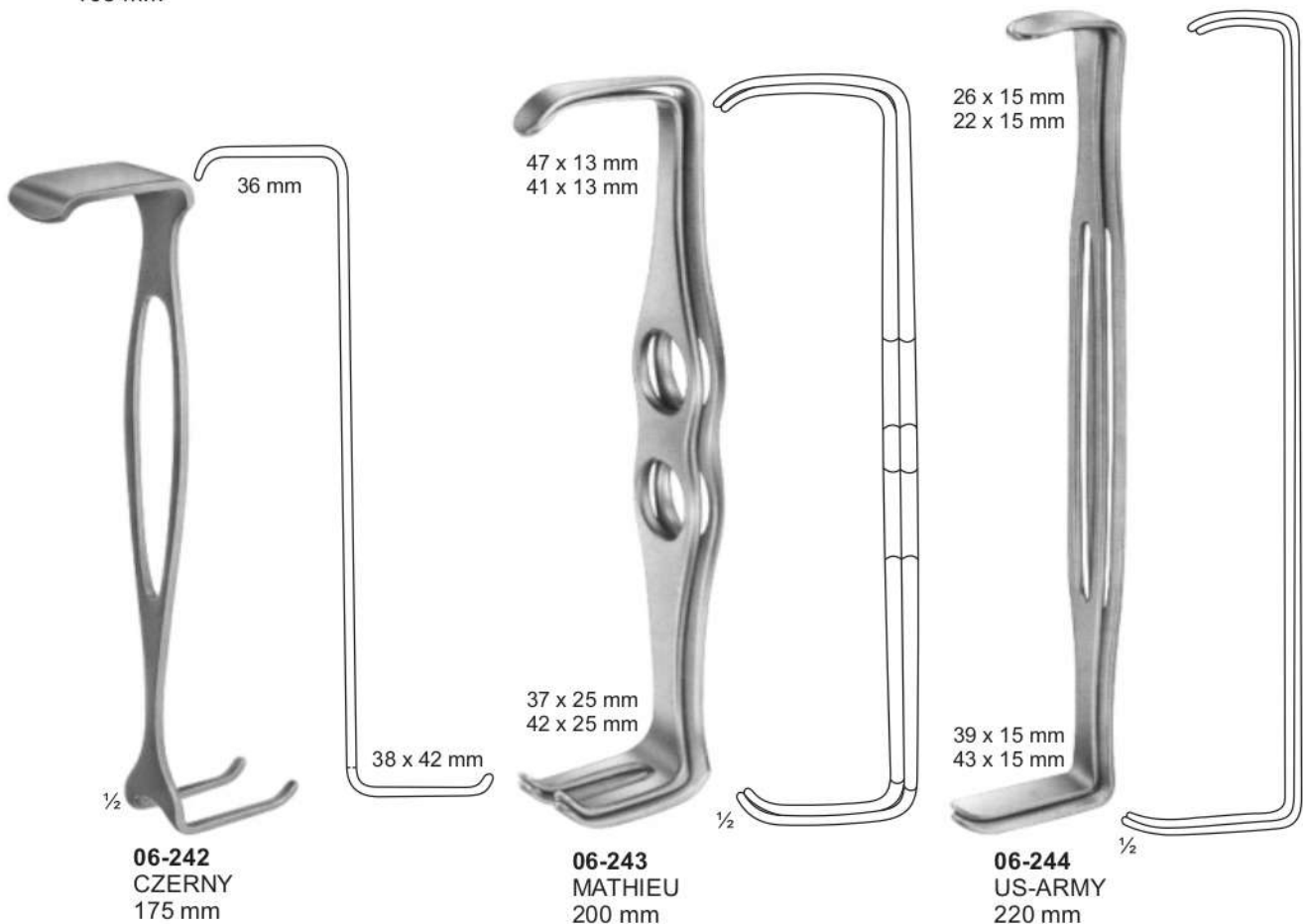
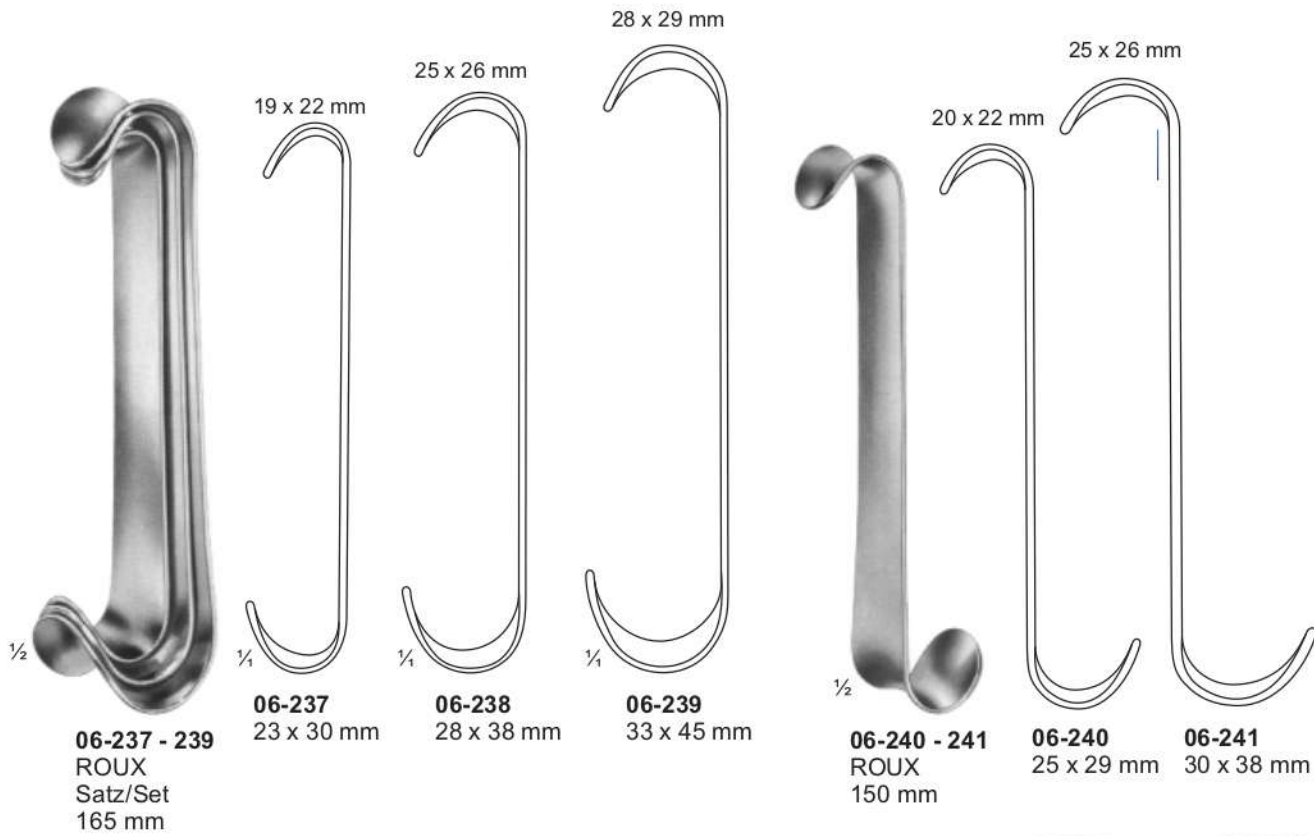



**06-245**  
**KOCHER**  
 Sharp  
 205 mm



**06-246**  
**KOCHER**  
 Sharp  
 220 mm



**06-247**  
**KOCHER**  
 Blunt  
 220 mm



**06-248**  
**VOLKMANN**  
 Sharp  
 220 mm



**06-249**  
**VOLKMANN**  
 Sharp  
 220 mm



**06-250 - 257**  
**VOLKMANN**  
 225 mm

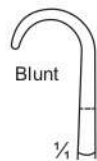
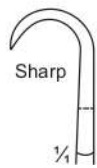

**06-250**  
 9 x 8 mm



**06-251**  
 9 x 13 mm



**06-252**  
 9 x 19 mm



**06-253**  
 9 x 29 mm



**06-254**  
 8,5 x 8 mm



**06-255**  
 8,5 x 13 mm



**06-256**  
 8,5 x 19 mm



**06-257**  
 8,5 x 29 mm



Retractors  
Retraktoren  
Retradores

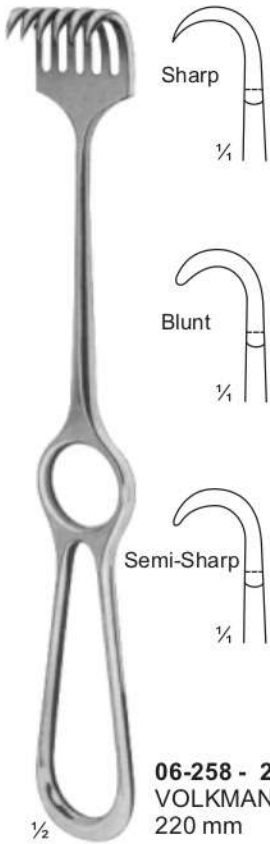

**06-258 - 271**  
VOLKMANN  
220 mm

<b>06-258</b> 9 x 8 mm	<b>06-259</b> 9 x 13 mm	<b>06-260</b> 9 x 19 mm	<b>06-261</b> 9 x 29 mm	<b>06-262</b> 9 x 40 mm
<b>06-263</b> 8 x 8 mm	<b>06-264</b> 8 x 13 mm	<b>06-265</b> 8 x 19 mm	<b>06-266</b> 8 x 29 mm	<b>06-267</b> 8 x 40 mm
<b>06-268</b> 8,5 x 8 mm	<b>06-269</b> 8,5 x 13 mm	<b>06-270</b> 8,5 x 19 mm	<b>06-271</b> 8,5 x 29 mm	

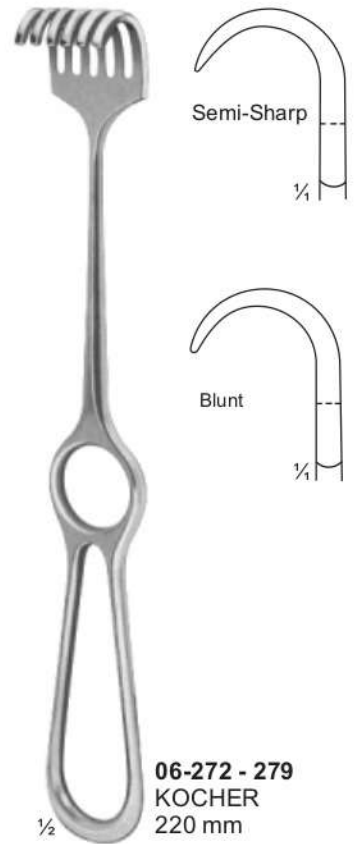

**06-272 - 279**  
KOCHER  
220 mm

<b>06-272</b> 16 x 9 mm	<b>06-273</b> 16 x 14 mm	<b>06-274</b> 16 x 20 mm	<b>06-275</b> 16 x 30 mm
<b>06-276</b> 15,5 x 9 mm	<b>06-277</b> 15,5 x 14 mm	<b>06-278</b> 15,5 x 20 mm	<b>06-279</b> 15,5 x 30 mm

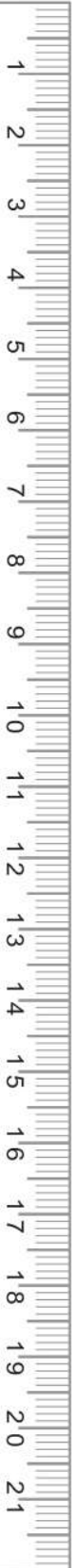

**06-280 - 281**  
KORTE  
240 mm



**06-280**  
8 Prongs, blunt



**06-281**  
8 Prongs, sharp



**06-282 - 285**  
ISRAEL  
255 mm

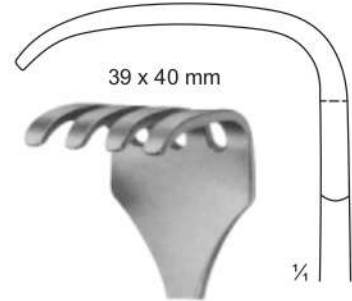

**06-282**  
4 Prongs, blunt

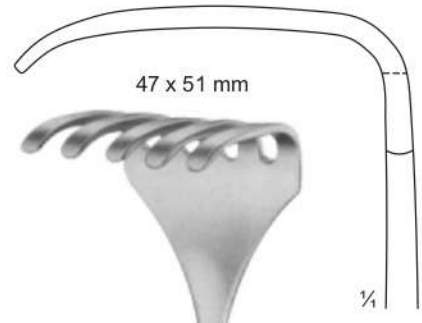

**06-283**  
5 Prongs, blunt

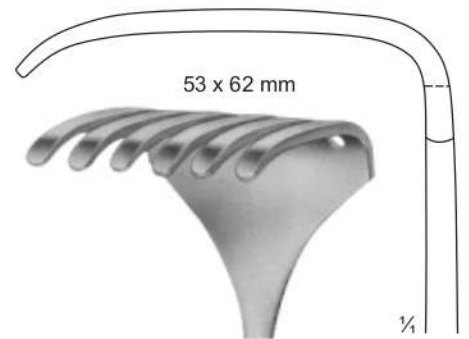

**06-284**  
6 Prongs, blunt

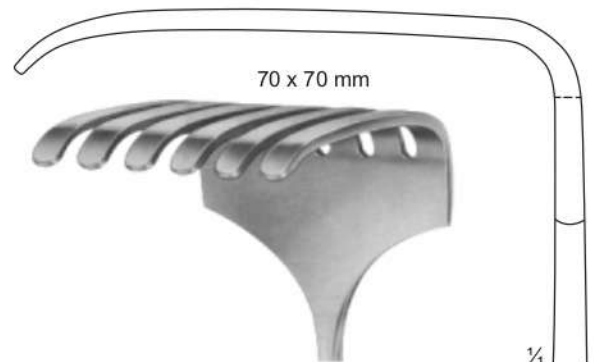

**06-285**  
6 Prongs, blunt



**06-286 - 291**  
LANGENBECK  
210 mm

- 06-286** 28 x 10 mm
- 06-287** 28 x 14 mm
- 06-288** 33 x 14 mm
- 06-289** 28 x 16 mm
- 06-290** 40 x 10 mm
- 06-291** 40 x 13 mm



**06-292 - 298**  
KOCHER-LANGENBECK  
215 mm

- 06-292** 25 x 6 mm
- 06-293** 35 x 8 mm
- 06-294** 35 x 11 mm
- 06-295** 35 x 15 mm
- 06-296** 41 x 11 mm
- 06-297** 55 x 11 mm
- 06-298** 70 x 14 mm

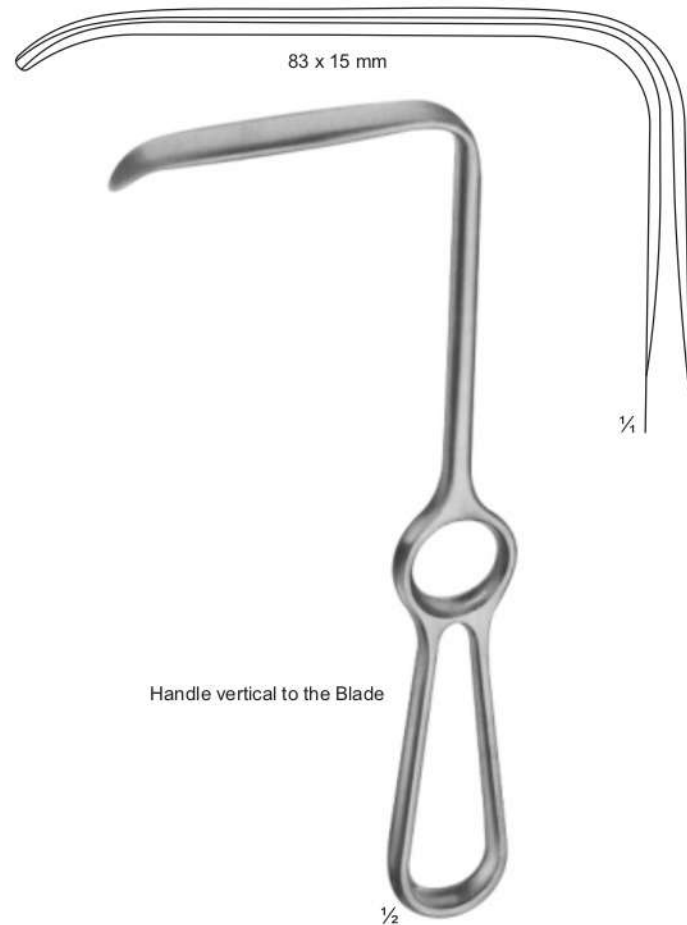

**06-299**  
LANGENBECK  
215 mm

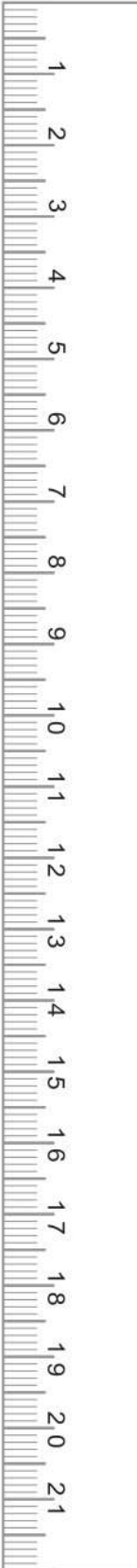

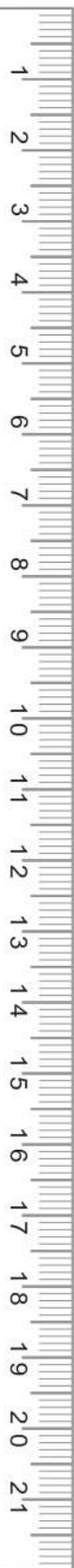

**06-300 - 304**  
KOCHER  
230 mm

1/2



**06-305 - 307**  
SAUERBRUCH  
225 mm

1/2

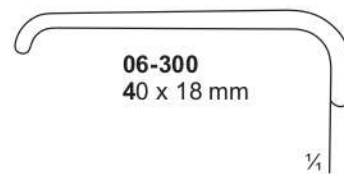

**06-300**  
40 x 18 mm

1/4

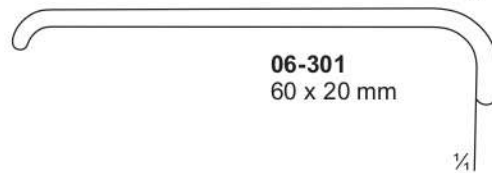

**06-301**  
60 x 20 mm

1/4

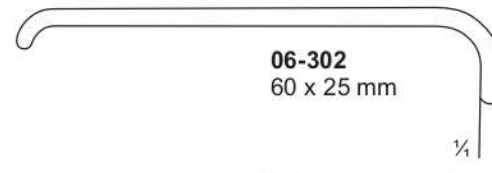

**06-302**  
60 x 25 mm

1/4



**06-303**  
75 x 30 mm

1/4

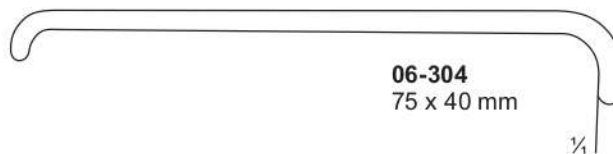

**06-304**  
75 x 40 mm

1/4

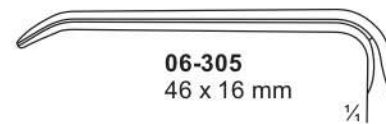

**06-305**  
46 x 16 mm

1/4

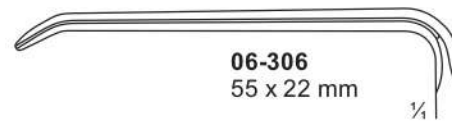

**06-306**  
55 x 22 mm

1/4



**06-307**  
72 x 19 mm

1/4





Retractors  
Retraktoren  
Retradores



**06-308**  
15 x 15 mm  
220 mm

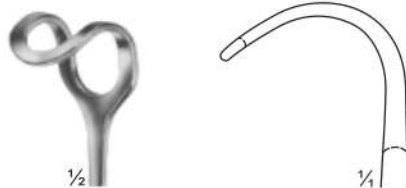

**06-309**  
20 x 22 mm  
215 mm

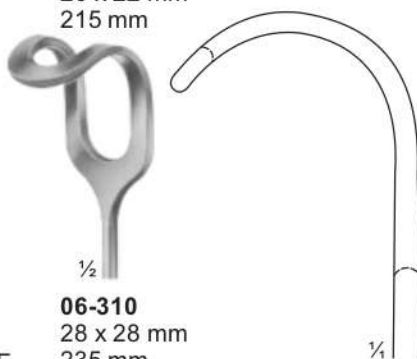

**06-310**  
28 x 28 mm  
235 mm

**06-308 - 310**  
MIDDELDORPF

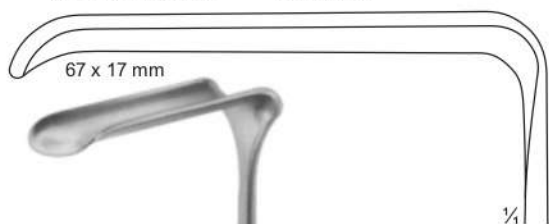

67 x 17 mm

**06-312**  
CASPAR  
210 mm

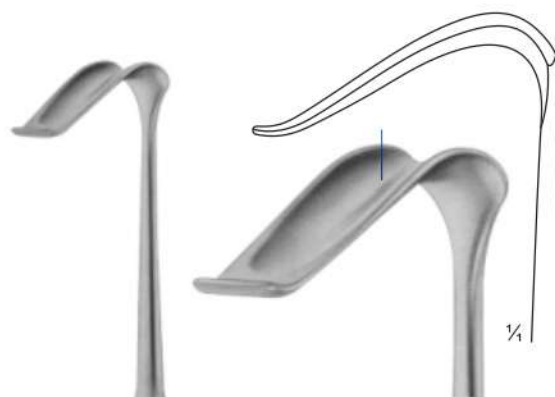

38 x 18 mm

**06-311**  
BUCHS  
205 mm



36 x 20 mm

**06-313**  
KOCHER  
230 mm



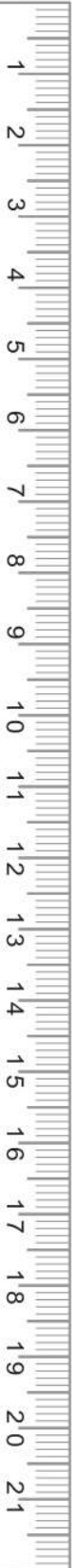

$\frac{1}{2}$   
**06-314 - 319**  
HOSEL  
250 mm

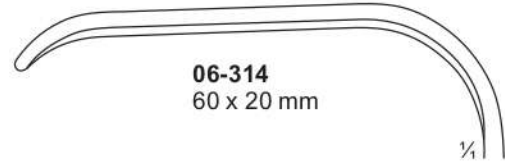

**06-314**  
60 x 20 mm

$\frac{1}{4}$

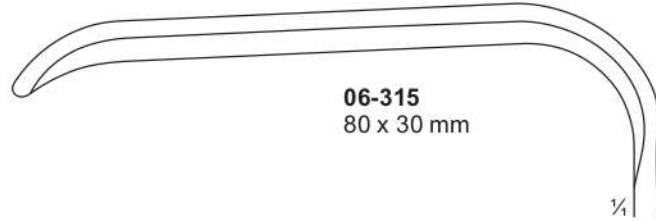

**06-315**  
80 x 30 mm

$\frac{1}{4}$

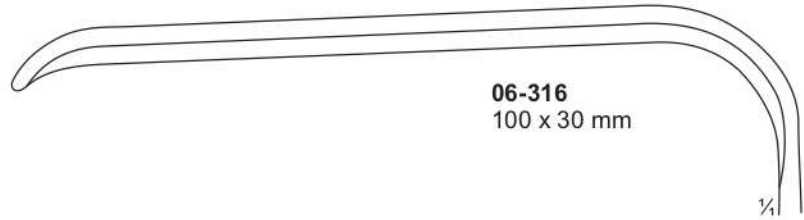

**06-316**  
100 x 30 mm

$\frac{1}{4}$

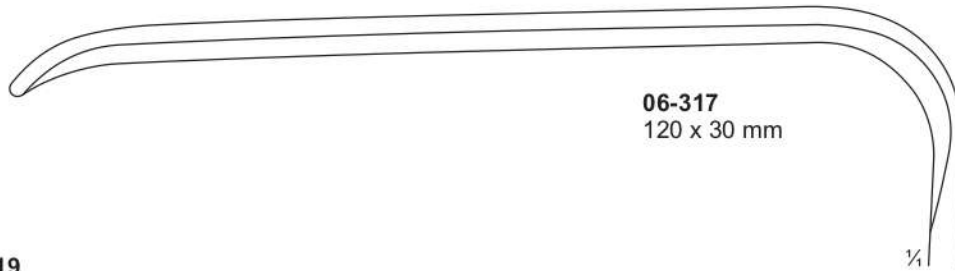

**06-317**  
120 x 30 mm

$\frac{1}{4}$

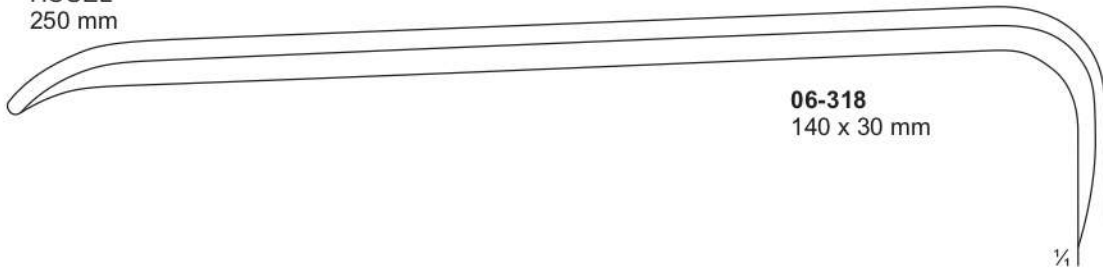

**06-318**  
140 x 30 mm

$\frac{1}{4}$

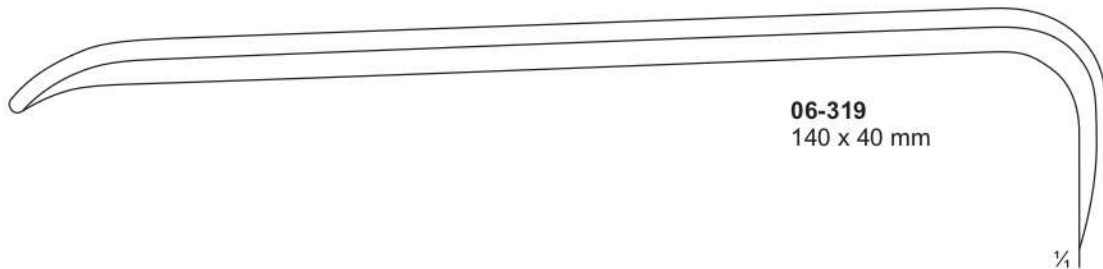

**06-319**  
140 x 40 mm

$\frac{1}{4}$



**Retractors**  
Retraktoren  
Retradores

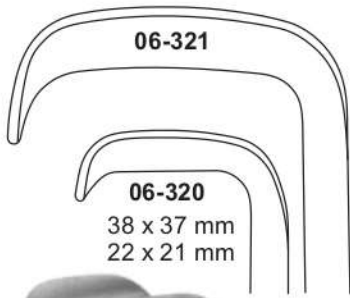

**06-321**

**06-320**

38 x 37 mm  
22 x 21 mm



**06-322**  
23 x 20 mm



**06-323**  
30 x 29 mm



**06-324**  
37 x 37 mm

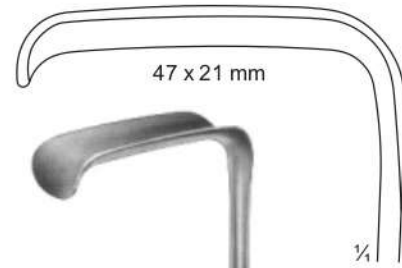

47 x 21 mm



1/2

29 x 30 mm  
64 x 43 mm

1/4

**06-320 - 321**  
RICHARDSON-EASTMAN  
Set-250 mm

**06-320** 250 mm  
**06-321** 270 mm



1/2

**06-322 - 324**  
RICHARDSON  
240 mm

1/2

**06-325**  
RICHARDSON  
240 mm

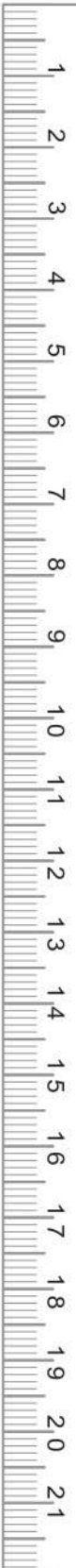

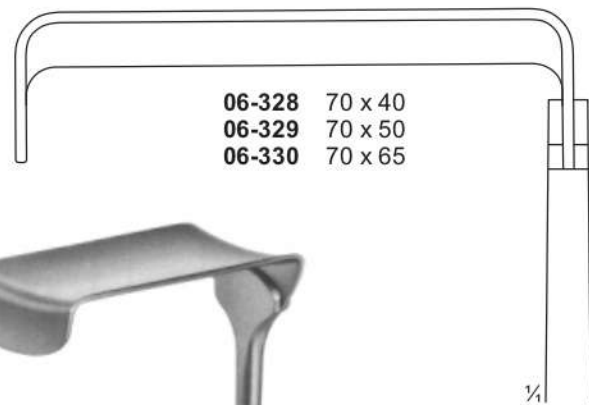
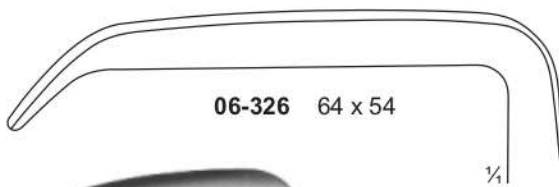
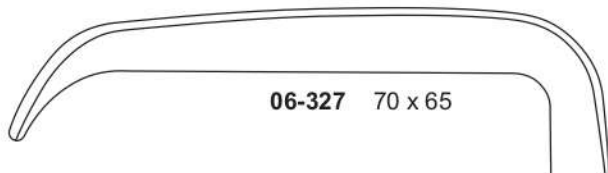
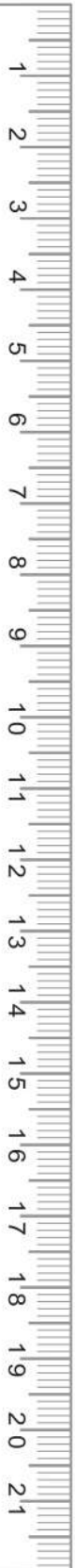

**06-326 - 327**  
KELLY  
260 mm



**06-328 - 330**  
MORRIS  
245 mm

**Retractors For Deep Surgery**  
**Retraktoren Für Tief Chirurgie**  
**Los Retractores Para Cirugía Profunda**



**MATU BROTHERS  
 SURGICAL**

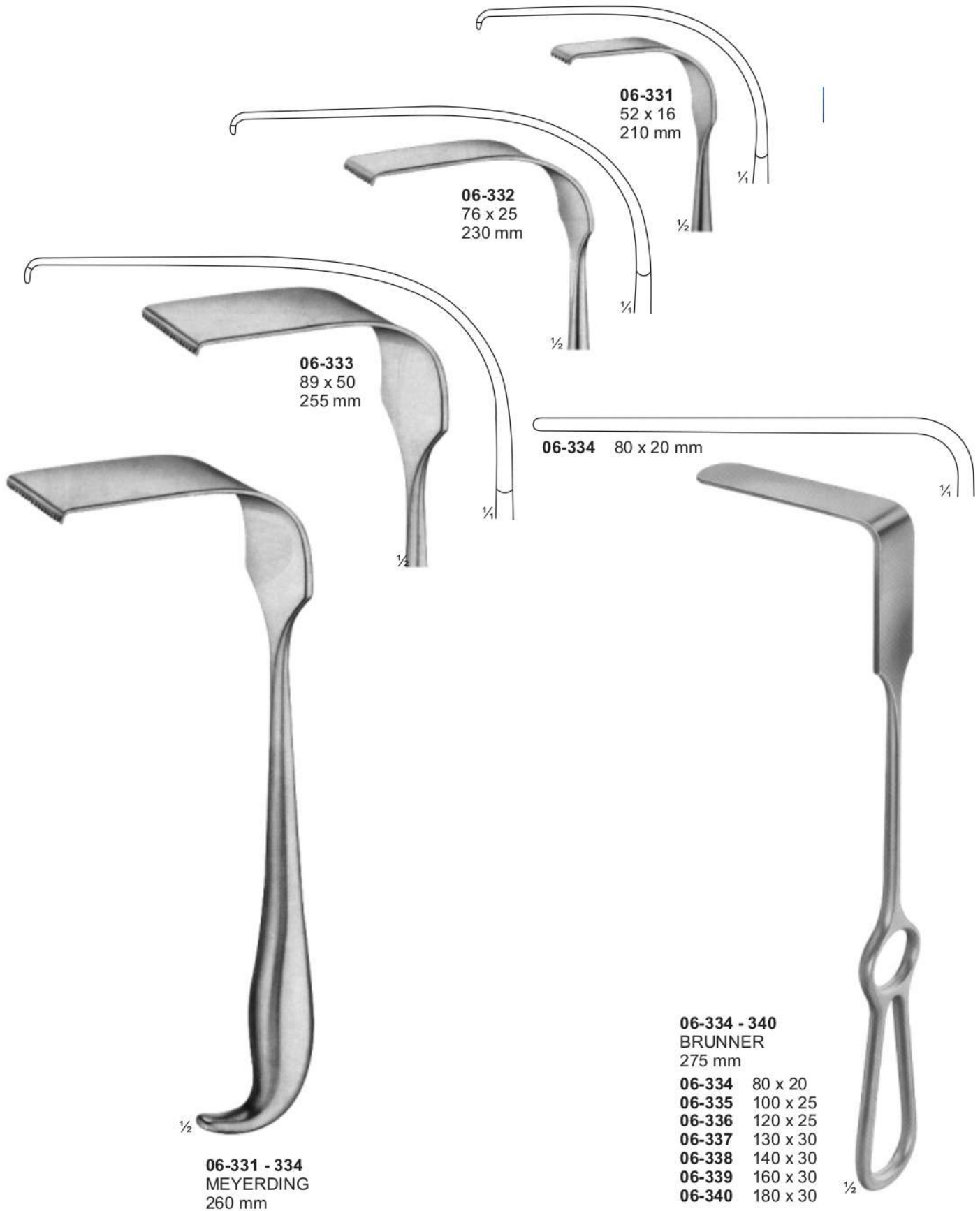



**MATU BROTHERS  
SURGICAL**

**Retractors For Deep Surgery**  
**Retraktoren Für Tief Chirurgie**  
**Los Retractores Para Cirugía Profunda**

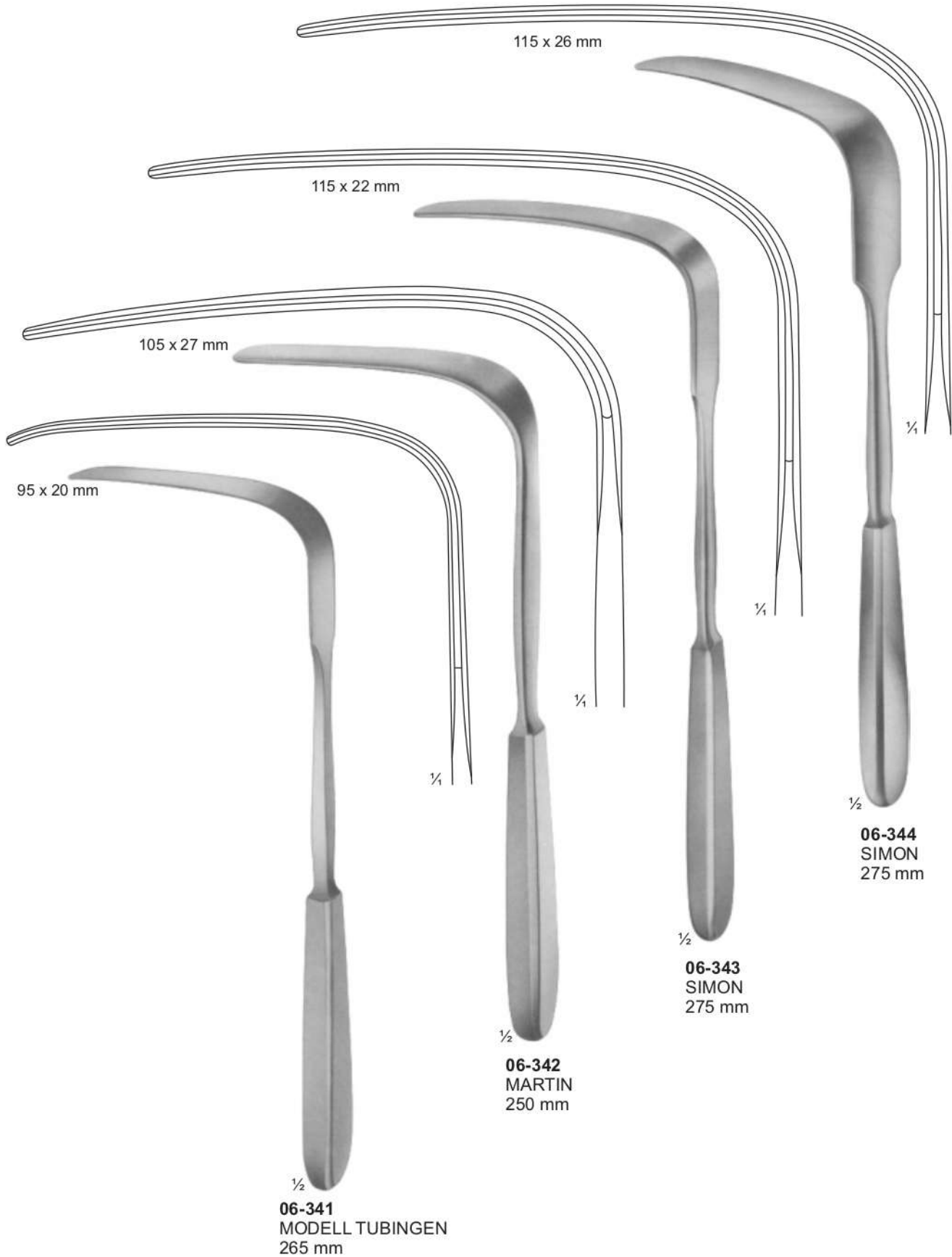
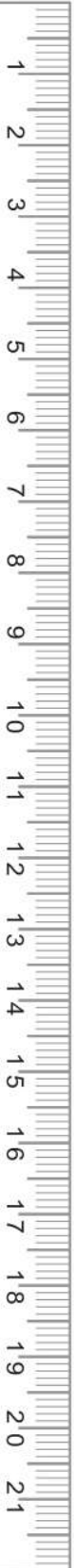



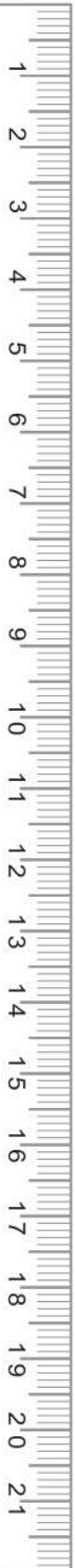

**06-348**  
DEAVER  
310 mm  
Fig. 1



**06-349**  
DEAVER  
310 mm  
Fig. 3





MATU BROTHERS  
SURGICAL

**Retractors For Deep Surgery (abdominal Retractors)**  
**Retraktoren Für Tief Chirurgie (bauchdeckenhalter)**  
**Los Retractores Para Cirugía Profunda (retractores Abdominales)**

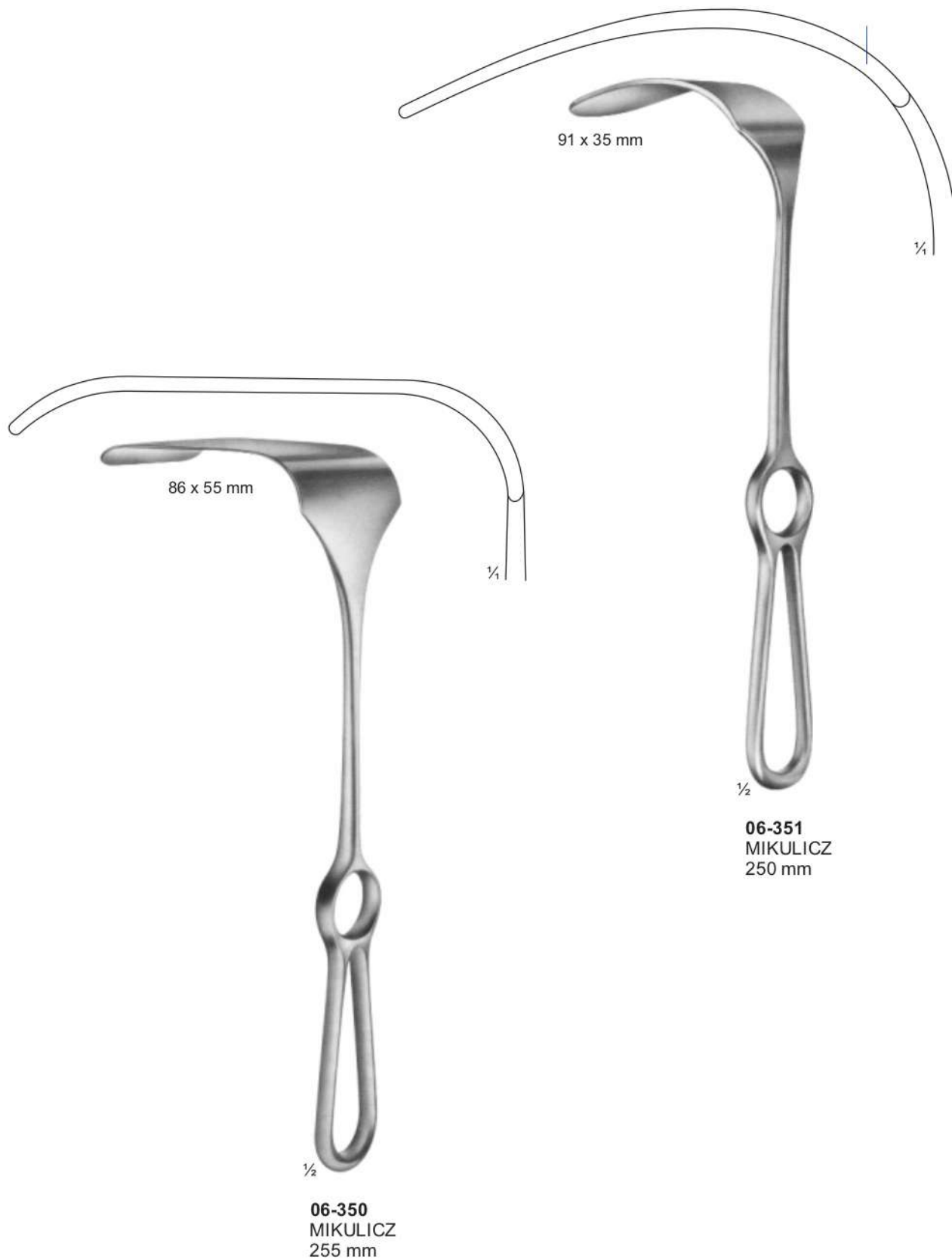

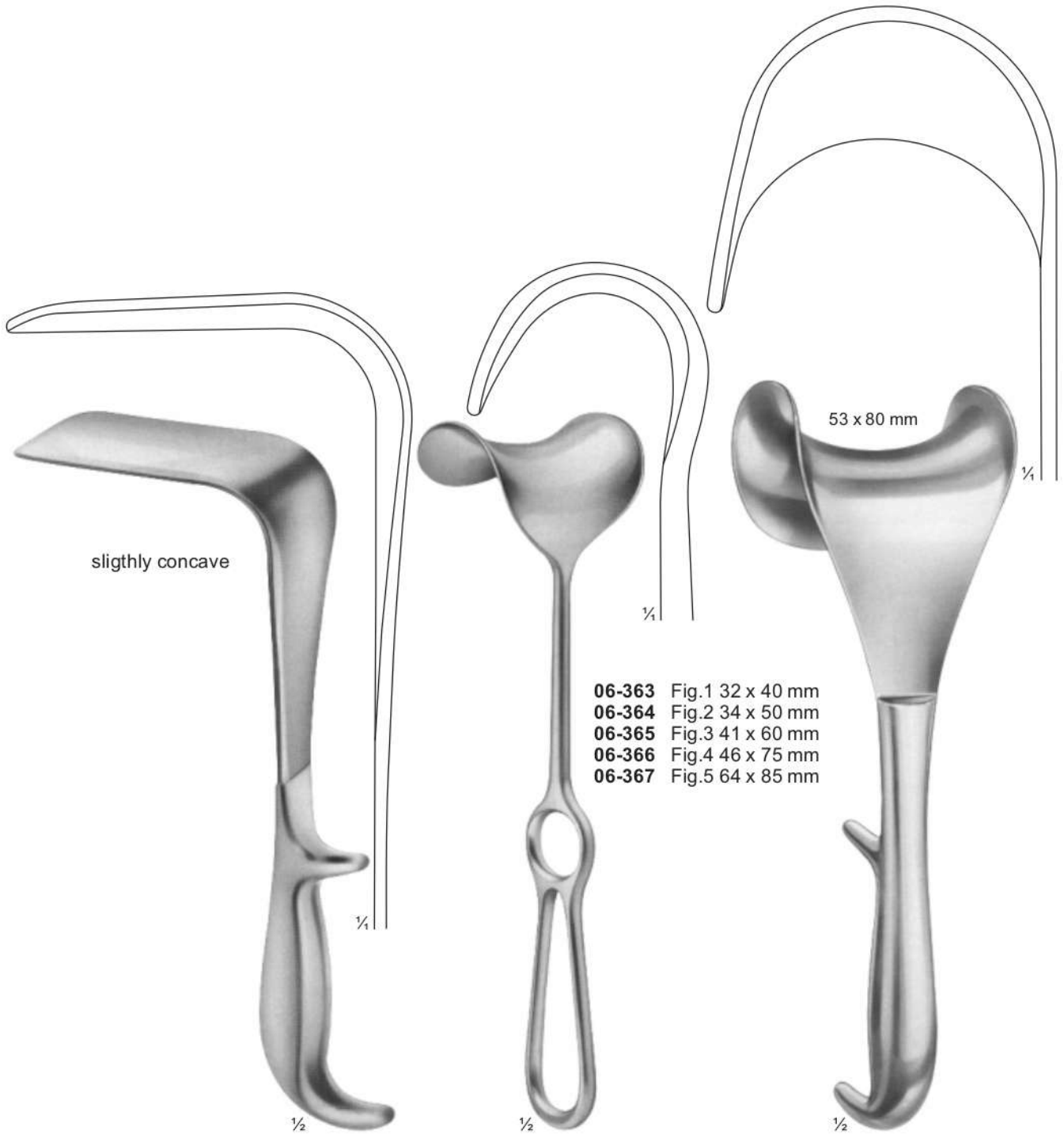
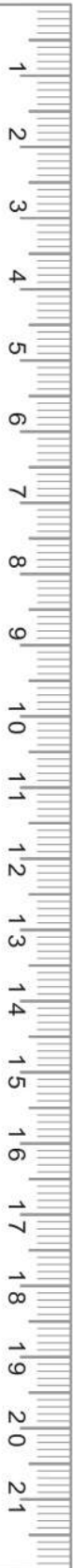

- 06-363** Fig.1 32 x 40 mm
- 06-364** Fig.2 34 x 50 mm
- 06-365** Fig.3 41 x 60 mm
- 06-366** Fig.4 46 x 75 mm
- 06-367** Fig.5 64 x 85 mm

**06-352 - 362**  
**DOYEN**  
 240 mm

**06-363 - 367**  
**FRITSCH**  
 240 mm

**06-368**  
**DOYEN**  
 250 mm

**Width of Blades**  
 35 mm, 45 mm, 60 mm

**Length of Blades**

62 mm	<b>06-352 , 06-356 , 06-360</b>
92 mm	<b>06-353 , 06-357 , 06-361</b>
122 mm	<b>06-354 , 06-358 , 06-362</b>
160 mm	<b>06-355 , 06-359</b>

**Pelvis Retractors**  
 Pelvis Retraktoren  
 Retractores Pelvis



**MATU BROTHERS  
 SURGICAL**

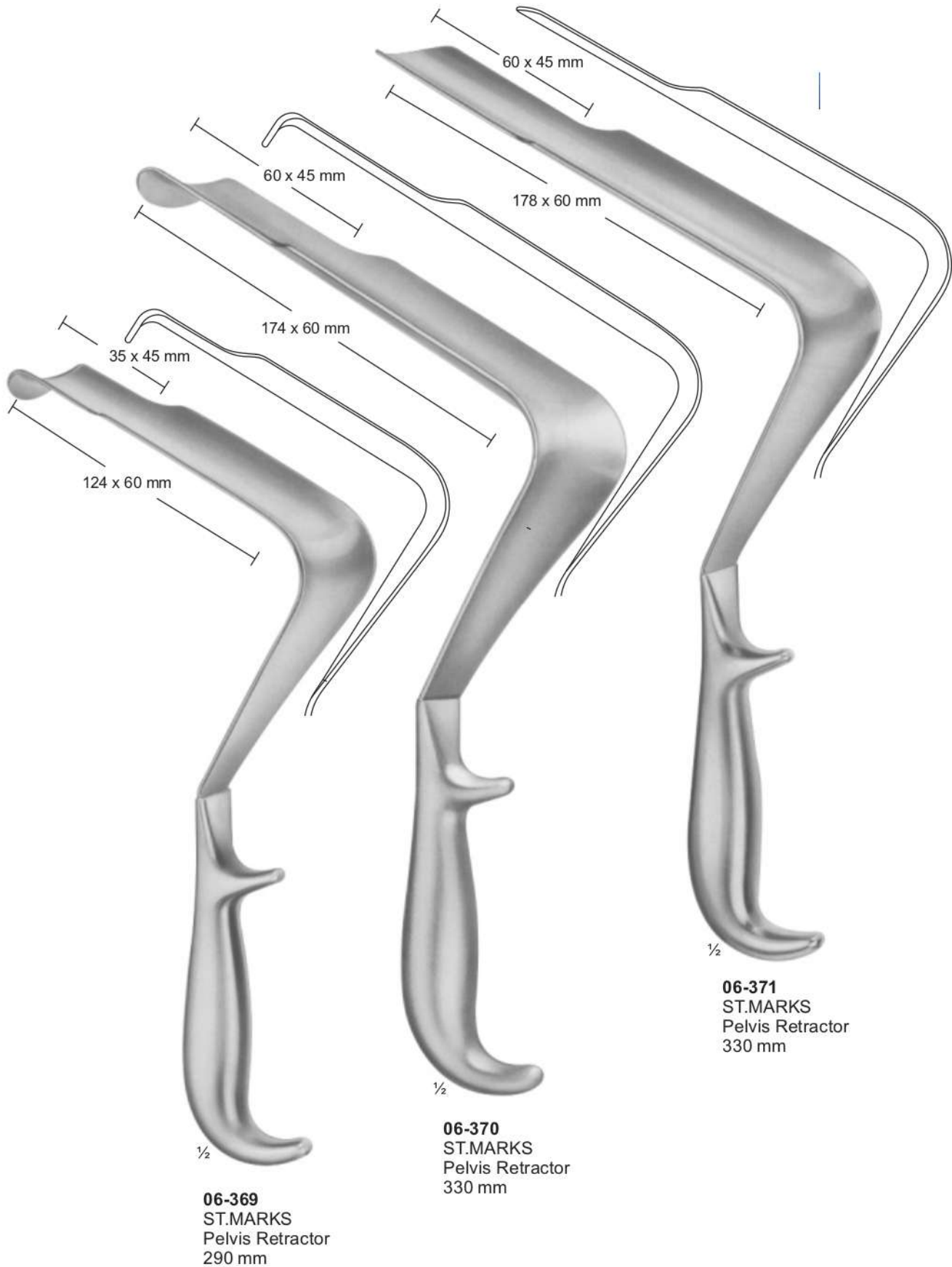

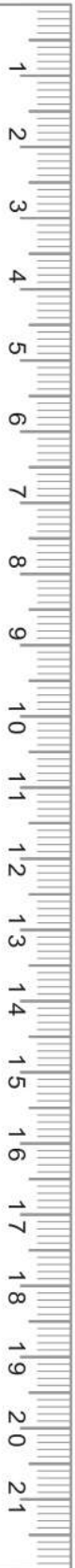

1/2

1/2

1/2

1/2

**06-372**  
LERICHE  
255 mm

**06-373**  
KUMMEL  
Malleable  
285 mm

**06-374**  
MIKULICZ  
29 mm  
250 mm

**06-375 - 376**  
KADER  
**06-375** 30 mm  
**06-376** 40 mm  
270 mm

**Abdominal- and Intestinal Spatulas**  
**Abdominal-und Darm-Spatel**  
**Abdominal y intestinales Espátulas**



**06-377**  
**REVERDIN**  
 285 mm



**06-378**  
**HABERER**  
 Malleable  
 305 mm



**06-379** 30 mm  
**06-380** 40 mm  
**06-381** 50 mm  
 Malleable  
 330 mm



**06-382**  
**TUFFIER**  
 Malleable  
 200 mm

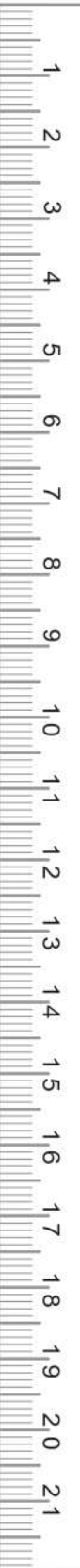



**06-377**  
**REVERDIN**  
 285 mm



**06-378**  
**HABERER**  
 Malleable  
 305 mm



**06-379** 30 mm  
**06-380** 40 mm  
**06-381** 50 mm  
 Malleable  
 330 mm



**06-382**  
**TUFFIER**  
 Melleable  
 200 mm

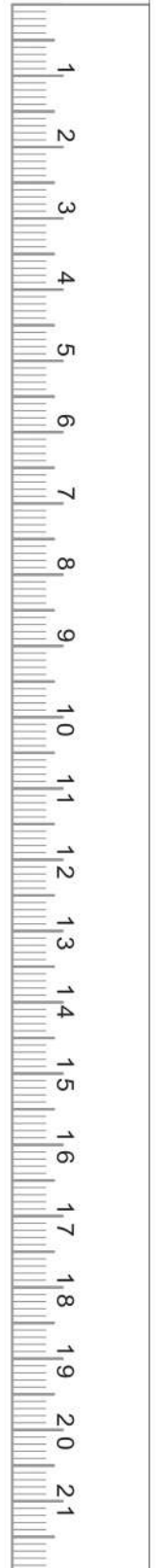

**Self-retaining Retractors**  
Wundspreizer  
Retención Auto-retractores

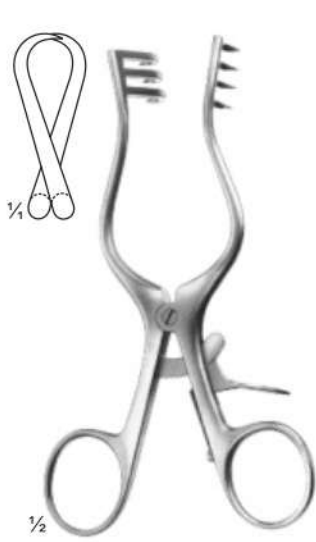

**06-389**  
WEITLANER  
Sharp  
130 mm

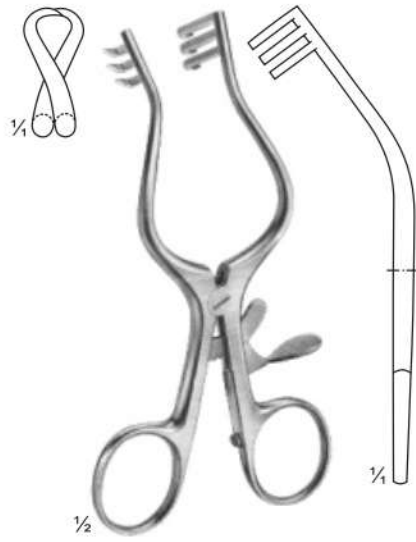

**06-390**  
WULLSTEIN  
Sharp  
130 mm

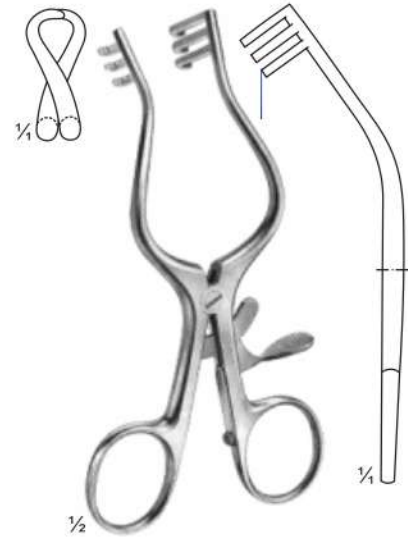

**06-391**  
WULLSTEIN  
Blunt  
130 mm



**06-392**  
WEITLANER  
Sharp  
165 mm

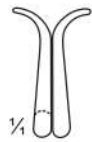

**06-393**  
PLESTER  
Blunt  
110 mm

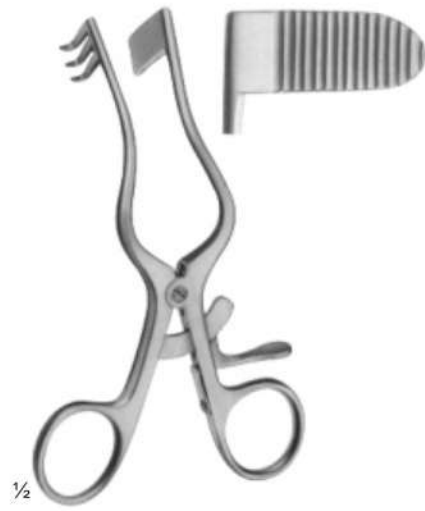

**06-394**  
PERKINS  
Blunt  
130 mm

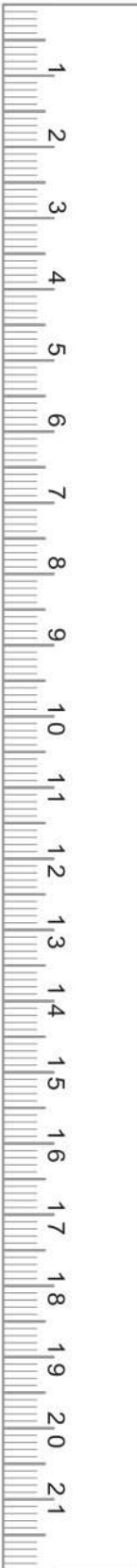

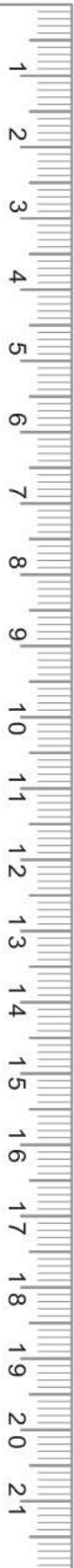

**06-395**  
ADSON-BABY  
Blunt  
140 mm

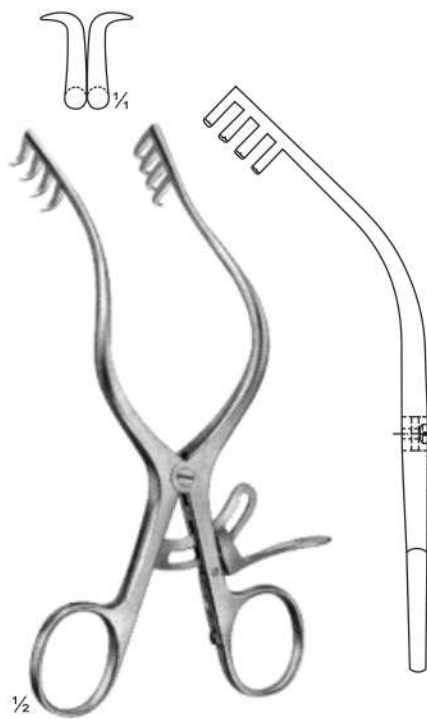

**06-396**  
MOLLISON  
Sharp  
155 mm



**06-397**  
MAYO-ADAMS  
165 mm



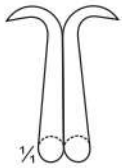

**06-398**  
**ANDERSON-ADSON**  
 Sharp  
 190 mm



**06-399**  
**NORFOLK and  
 NORWICH**  
 Blunt  
 220 mm



**06-400**  
**ADSON**  
 Sharp  
 265 mm

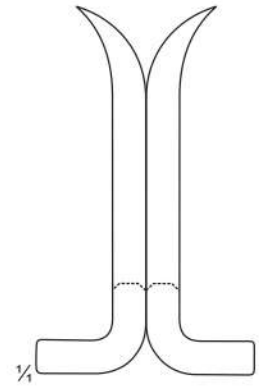
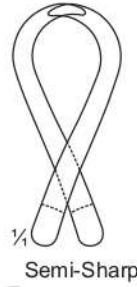
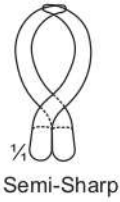
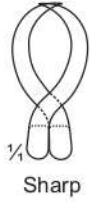
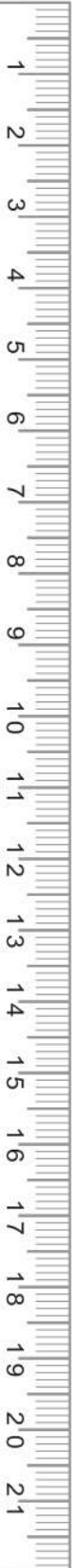

**06-401**  
**BECKMANN-ADSON**  
 Sharp  
 310 mm



**06-401A**  
**BECKMANN-ADS**  
 Semi-Sharp  
 310 mm



**06-402**  
**ADSON**  
 Semi-Sharp  
 320 mm



**06-403**  
**BECKMANN-EATON**  
 Sharp  
 320 mm



**Special Retractors**  
**Spezielle Wundhaken**  
**Los Retractores Especiales**

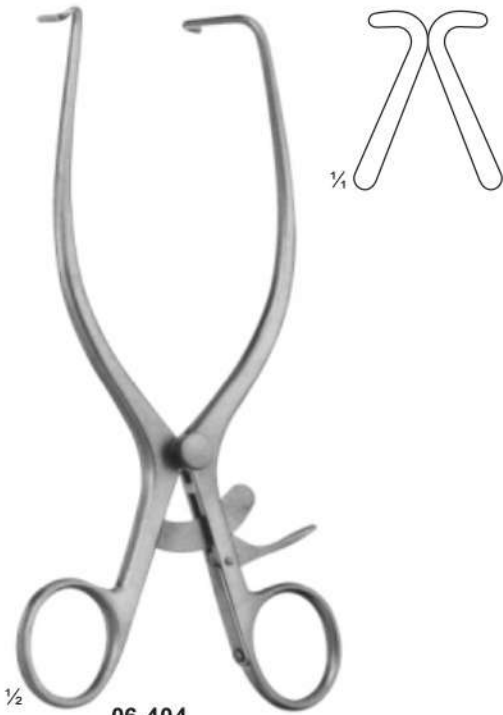

**06-404**  
**JACKSON BURROWS**  
Retractor, blunt  
185 mm



**06-405**  
**GELPI**  
Vaginal Retractor  
135 mm



**06-406**  
**GELPI**  
Skin- and Vaginal Retractor  
175 mm



**06-407**  
**DE BAKEY**  
Femur Retractor  
145 mm



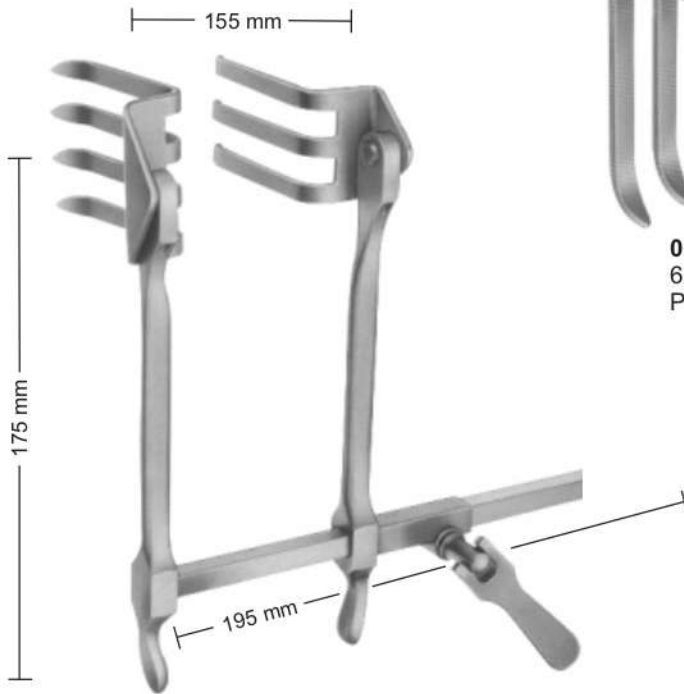
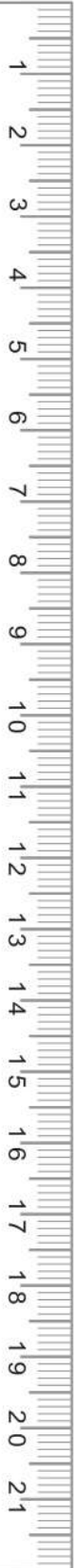

**06-408 - 411**  
 SCOVILLE-RICHTER  
 Retractor with 1 pair  
 blades reversible type.  
 The Retractor bar and  
 shanks may be easily  
 rotated 180 when  
 blades are in situ.



**06-408**  
 62 x 52 mm    62 x 37 mm  
 PR= Pair



**06-409**  
 47 x 51 mm



**06-410**  
 30 x 40 mm



**06-411**  
 37 x 62 mm



**06-412**  
 CLOWARD  
 155 mm

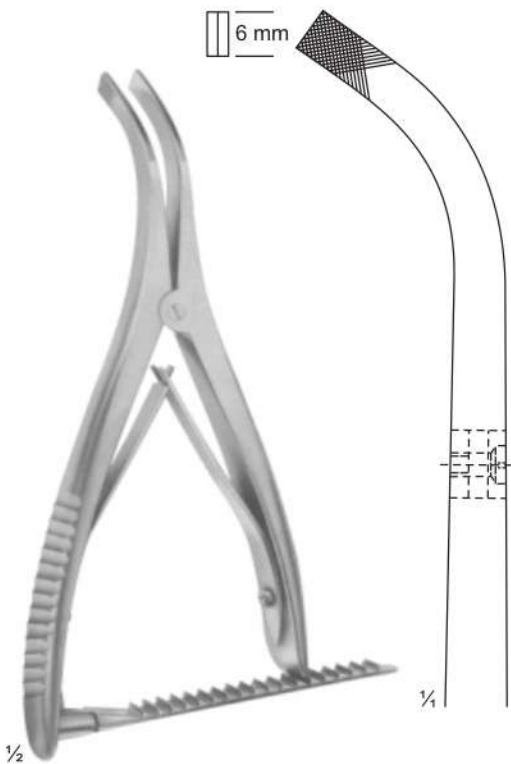

**06-413**  
 INGE  
 170 mm

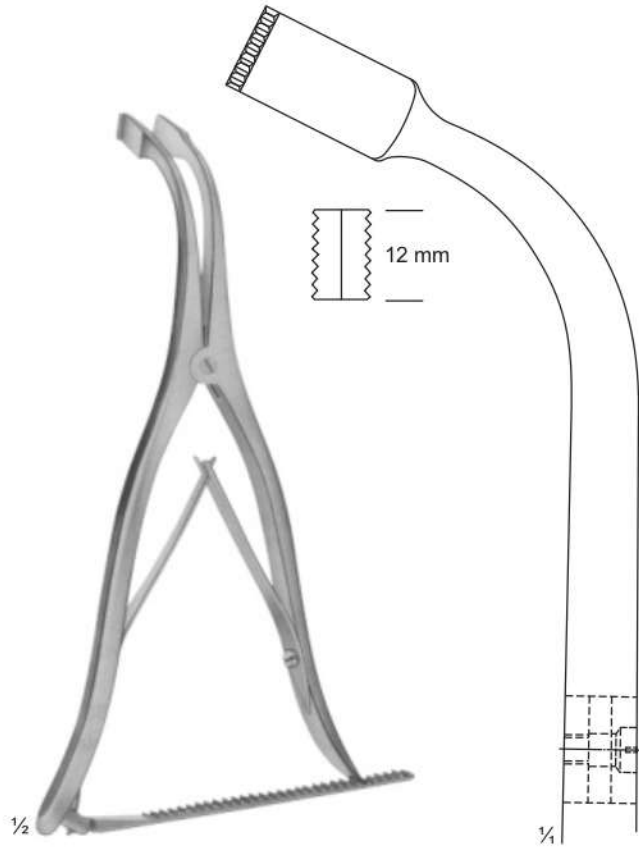

**06-414**  
 INGE  
 275 mm

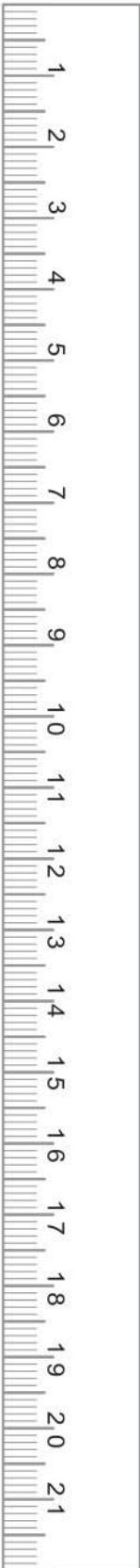

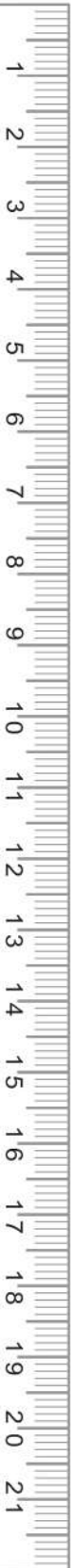

**06-415**  
BABY-COLLIN  
with 2 pair of blades

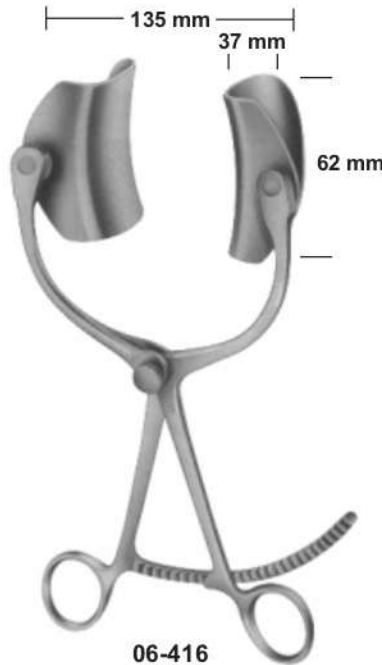

**06-416**  
COLLIN  
complete

06-420 135 mm  
06-421 160 mm



**06-417 - 421**  
COLLIN  
complete

Spreader only **06-417** **06-418** **06-419**  
Lateral blade 37x62mm 37x80mm 37x98mm  
Canter blade 54x55mm 54x67mm 52x76mm



**06-422 - 223**  
RICARD  
complete

Spreader only **06-422** **06-423**  
Lateral blade 58x80mm 72x84mm  
Canter blade 54x70mm 72x90mm



**06-424 - 426**  
HOLZBACH  
Complete

**06-424** Spreader only  
**06-425** Lateral blade 59x80mm  
**06-426** Canter blade 74x82mm



Abdominal Retractors  
Bauchdeckenhalter  
Los Retractores Abdominales

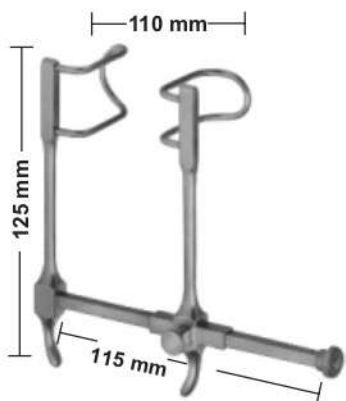

**06-427**  
GOSSET  
Blades:38 mm deep

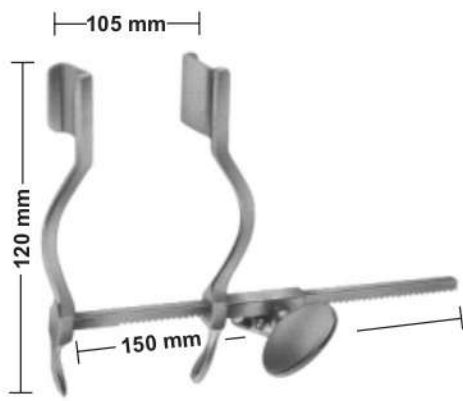

**06-428**  
HERTZLER  
Blades 20 X 25 mm

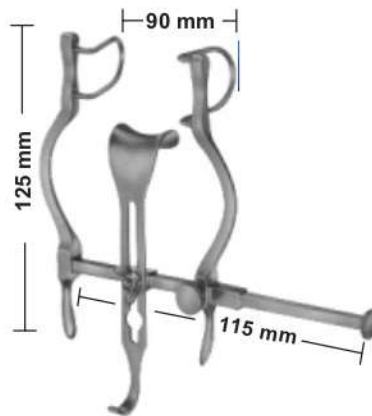

**06-429**  
BALFOUR-BABY  
Lateral blades 27 mm deep  
Center blade 21x24 mm

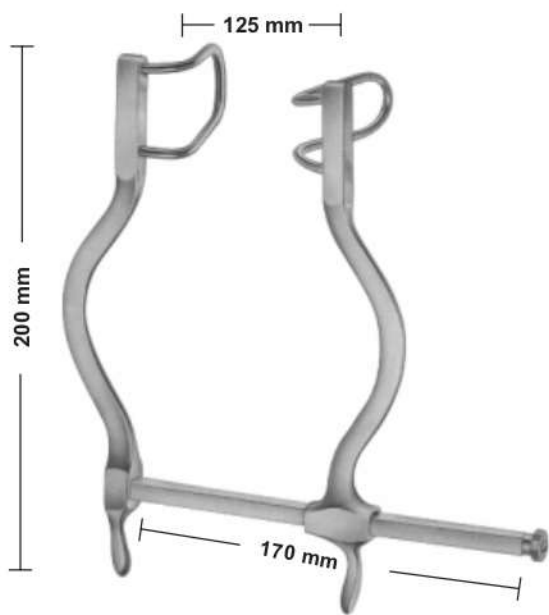

**06-430**  
GOSSET  
Blades:55mm deep

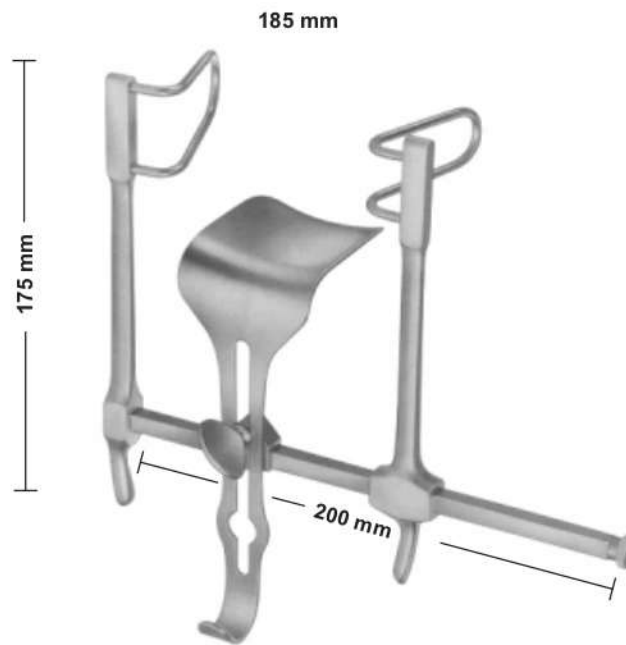

**06-431**  
GOSSET  
Lateral blades 58 mm deep  
Center blade 59 x 57 mm



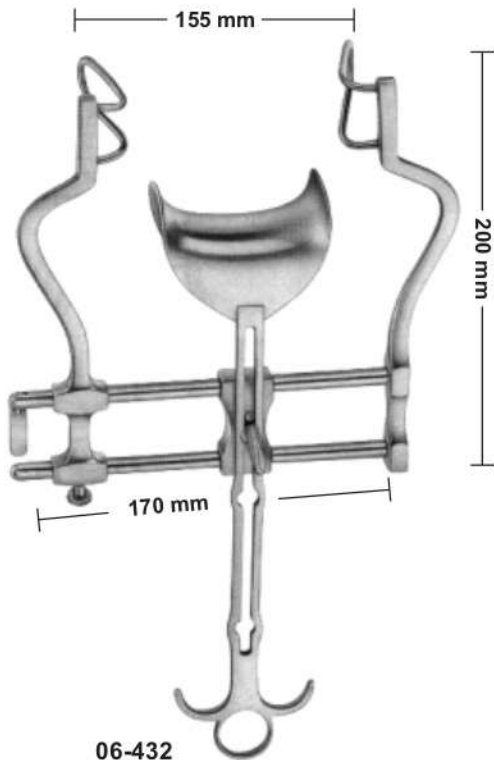

**06-432**  
BALFOUR  
Lateral blades 60 mm deep  
Center blade 47 x 80 mm

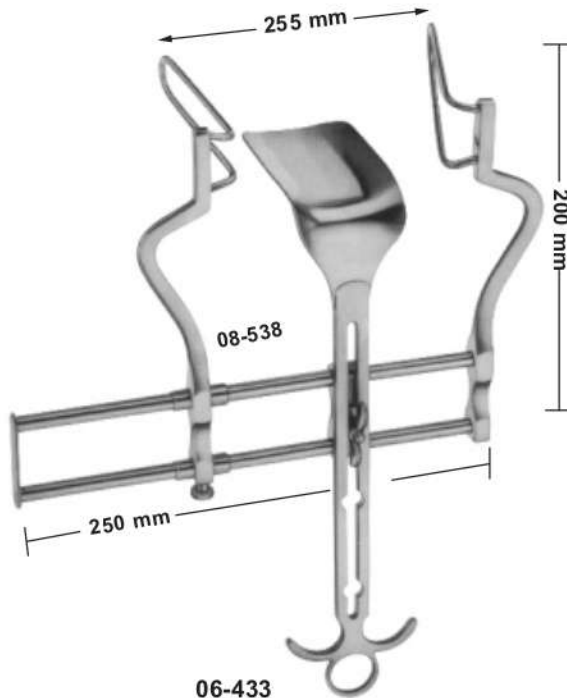

**06-433**  
BALFOUR  
Lateral blades 105 mm deep  
Center blade 107x 59 mm



**06-434**  
Center blade only  
54x80 mm

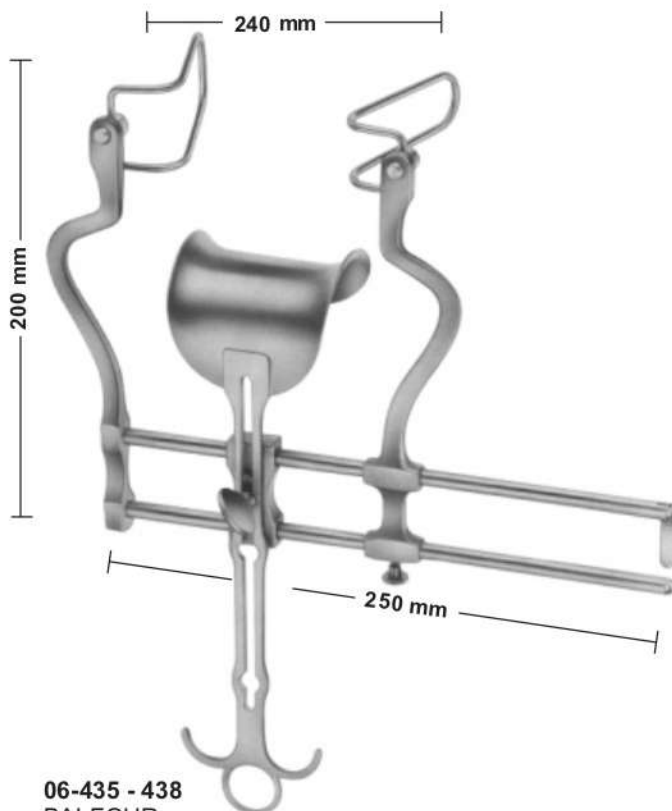

**06-435 - 438**  
BALFOUR  
Spreader only  
Lateral blades 06-435 50 mm    06-436 60 mm    06-437 75 mm    06-438 90 mm  
Center blade 47 x 80 mm    62x76 mm    80x80 mm    80x80 mm



Sales Unit of blades: PR = pair

Lateral blades  
**06-439** 50 mm deep  
**06-440** 60 mm deep  
**06-441** 75 mm deep  
**06-442** 90 mm deep



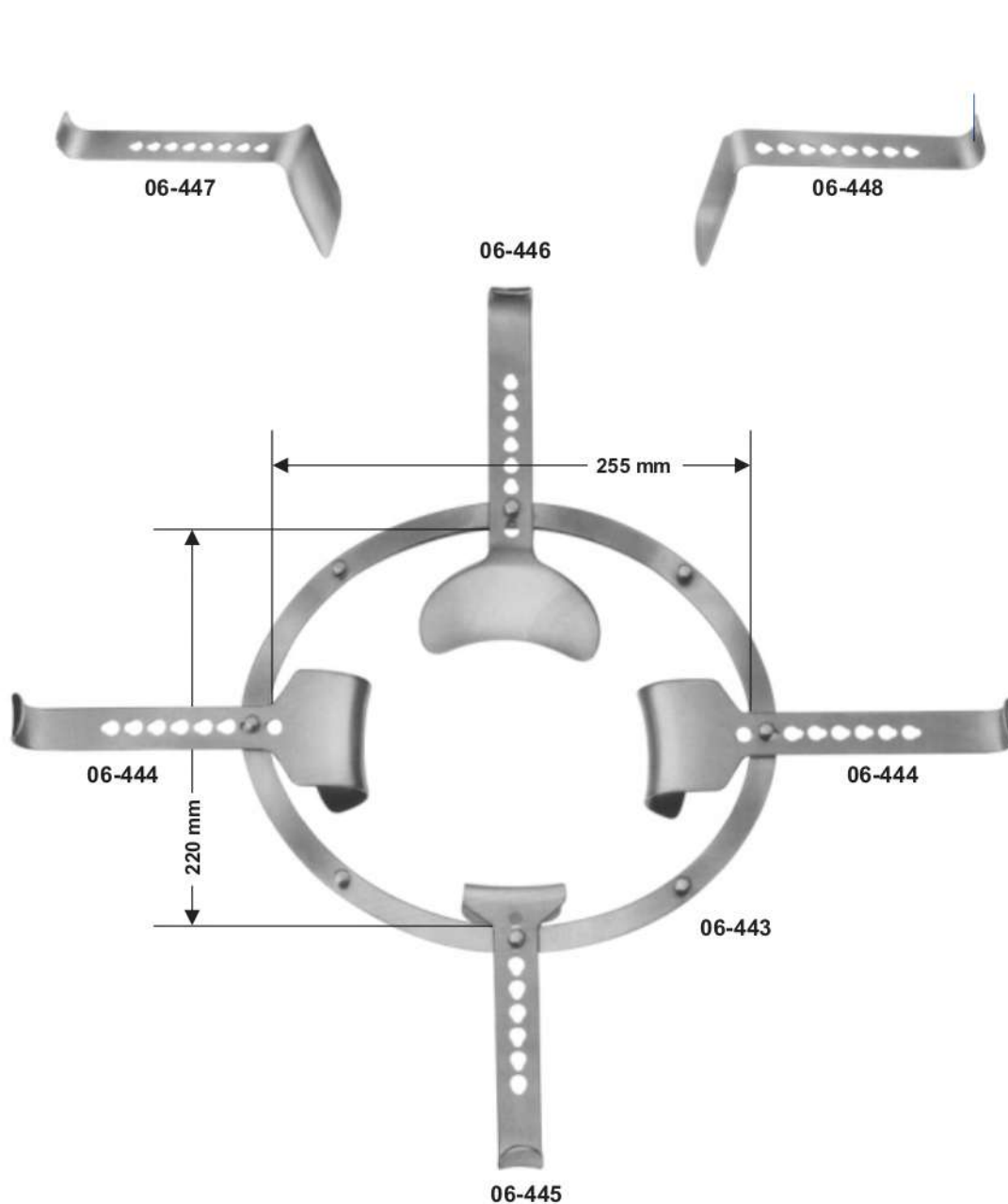

**06-443 - 06-448**

SEMM

consisting of:

**06-443** 1 frame 225 x 220 mm

**06-444** 2 blades 46 x 64 mm

**06-445** 1 blade 53 x 54 mm  
 (for bladder)

**06-446** 1 blade 82 x 97 mm  
 (for intestine)

**06-447** 1 blade 98 x 51 mm  
 (for intestine)

**06-448** 1 blade, narrow  
 107 x 36 mm

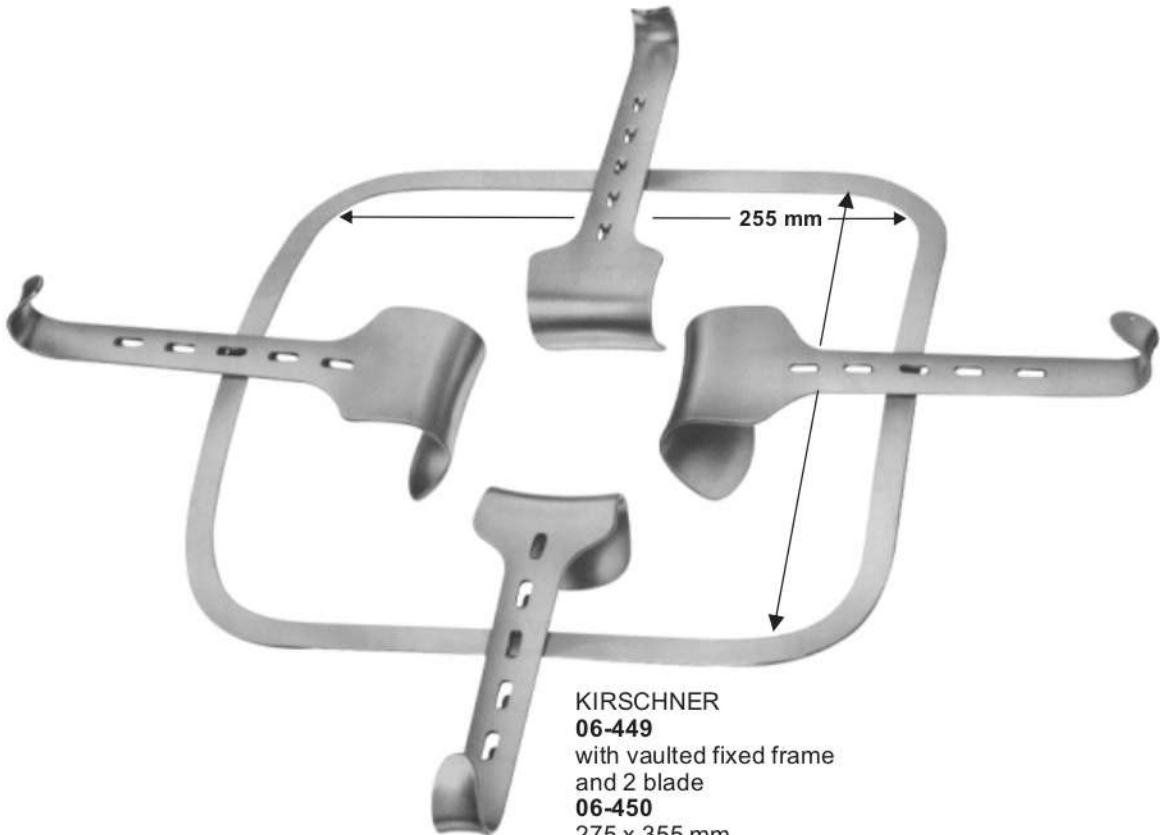
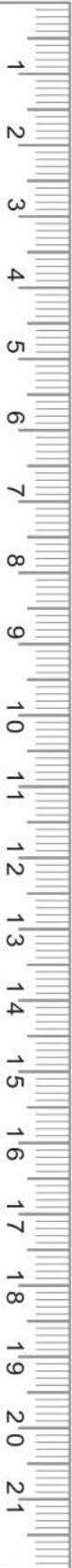

**KIRSCHNER  
06-449**  
with vaulted fixed frame  
and 2 blade  
**06-450**  
275 x 355 mm  
Frame only, over-sized  
**06-451**  
295 x 275 mm  
Frame only



**06-452**  
KIRSCHNER  
64 x 80 mm



**06-453**  
KIRSCHNER-BALFOUR  
80x 82 mm



**06-454 - 456**  
KIRSCHNER  
**06-454** 90x 69mm  
**06-455** 92x 95mm  
**06-456** 78x 58mm



**06-457 - 459**  
KIRSCHNER  
**06-457** 108x42mm  
**06-458** 91x 55mm  
**06-459** 121x 55mm

**Intestinal And Tissue Grasping Forceps**  
**Darm-und Tissue Faßzange**  
**Pinzas De Agarre Intestinales Y Tisulares**

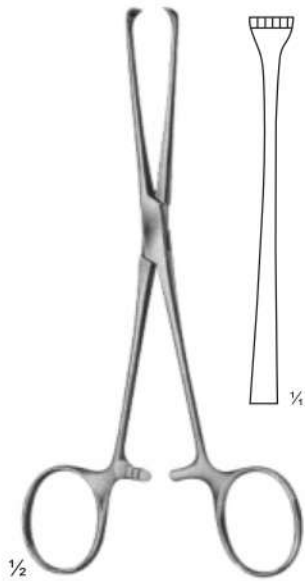

**06-460**  
**BOYS-ALLIS**  
 5 X 6 teeth, sharp  
 155 mm,

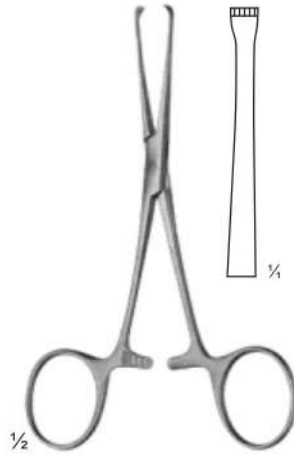

**06-461**  
**ALLIS**  
 4 X 5 teeth  
 155 mm,

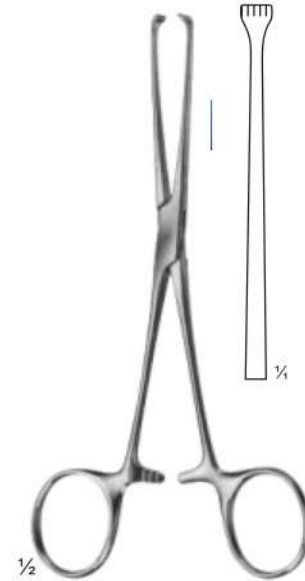

**06-462**  
**ALLIS**  
 155 mm,  
 4 X 5 teeth

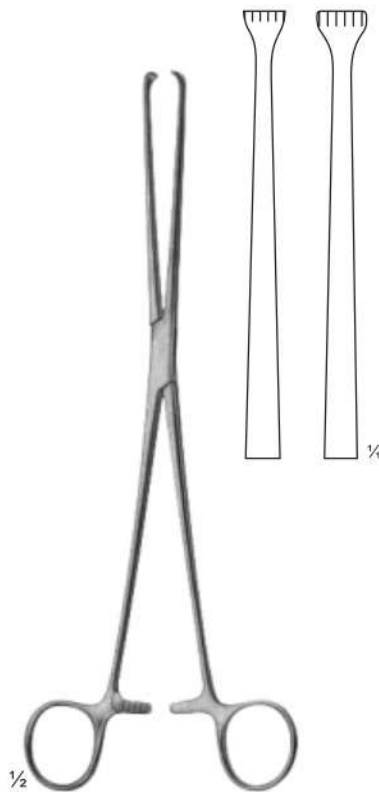

**06-463**  
**ALLIS**  
 190 mm,  
**06-464**  
 255 mm,  
 5 X 6 teeth

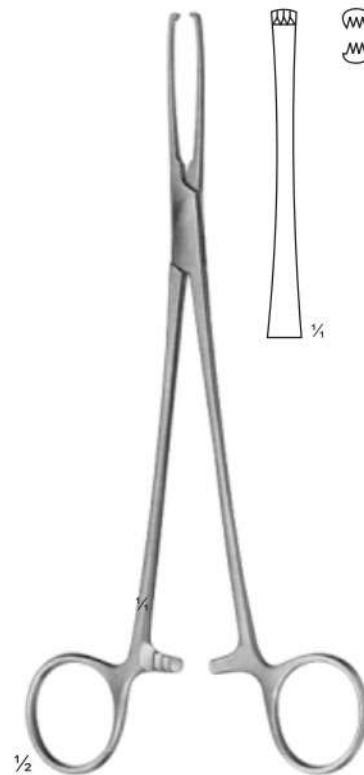

**06-465**  
**JUDD-ALLIS**  
 3 X 4 teeth  
 195 mm,



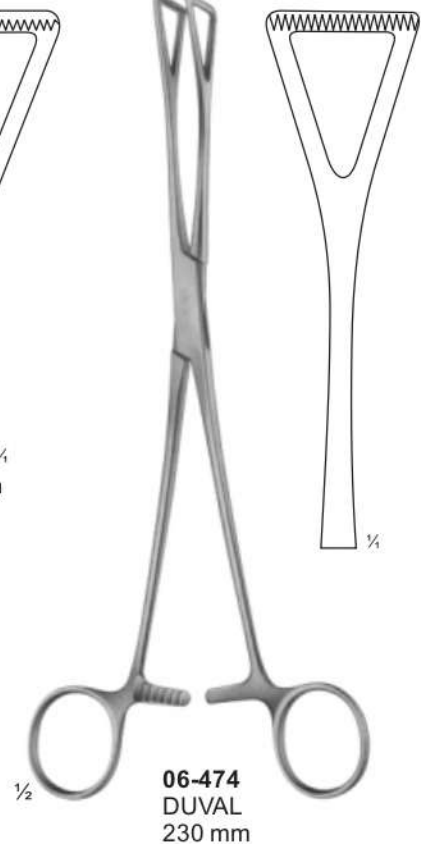
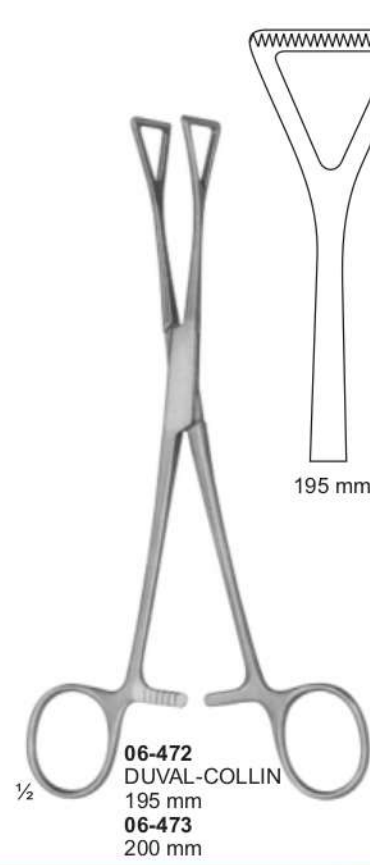
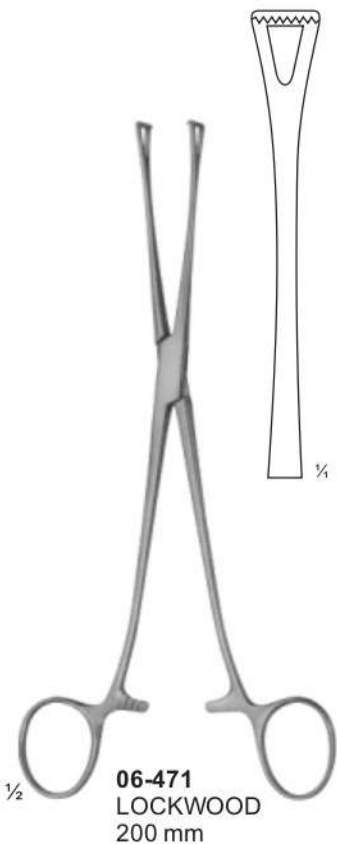
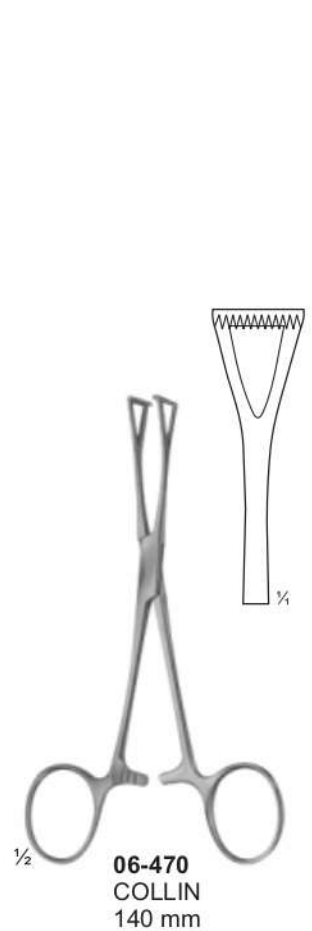
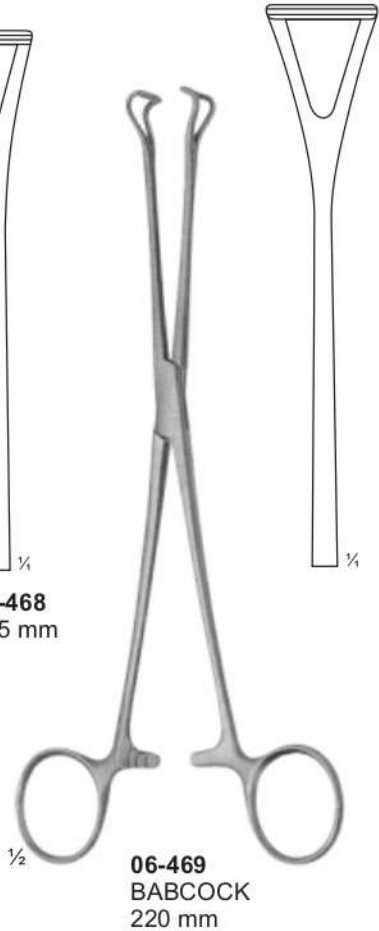
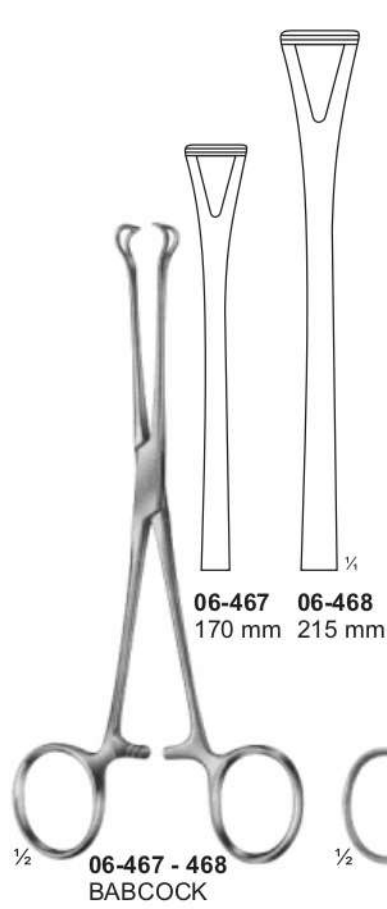
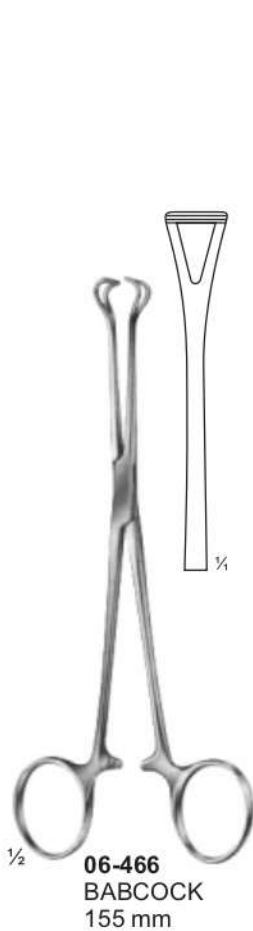



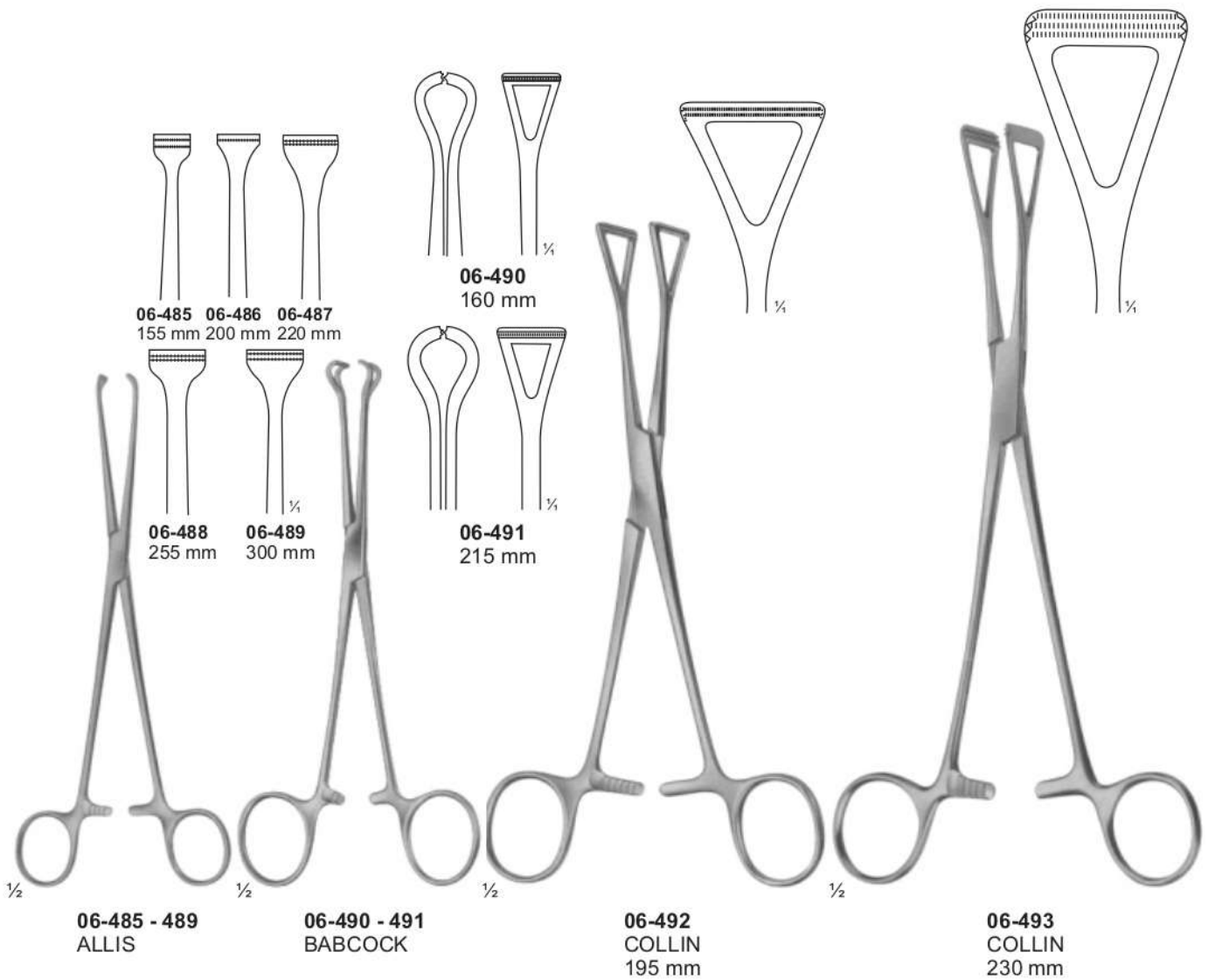



**Ultra - Light - Forceps, Dissecting Forceps**  
**Ultra - Light - Klemme, Dissektionszangen**  
**Pinzas, Pinzas De Disección - Ultra - Luz**

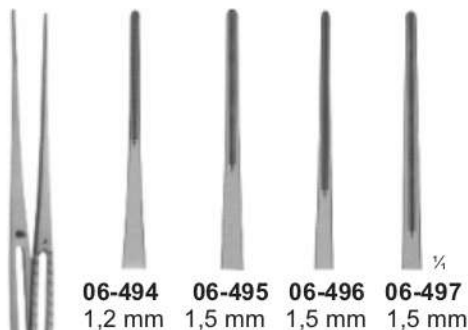

$\frac{1}{2}$   
**06-494** 150 mm  
**06-495** 200 mm  
**06-496** 240 mm  
**06-497** 300 mm

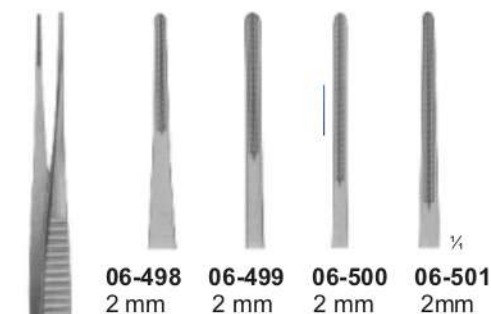

$\frac{1}{2}$   
**DE BAKEY**  
**06-498** 150 mm  
**06-499** 200 mm  
**06-500** 240 mm  
**06-501** 300 mm

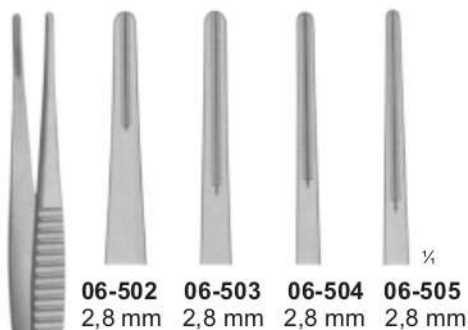

$\frac{1}{2}$   
**DE BAKEY**  
**06-502** 150 mm  
**06-503** 200 mm  
**06-504** 240 mm  
**06-505** 300 mm

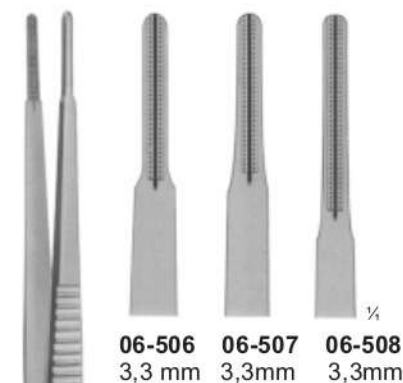

$\frac{1}{2}$   
**DE BAKEY**  
**06-506** 200 mm  
**06-507** 240 mm  
**06-508** 300 mm



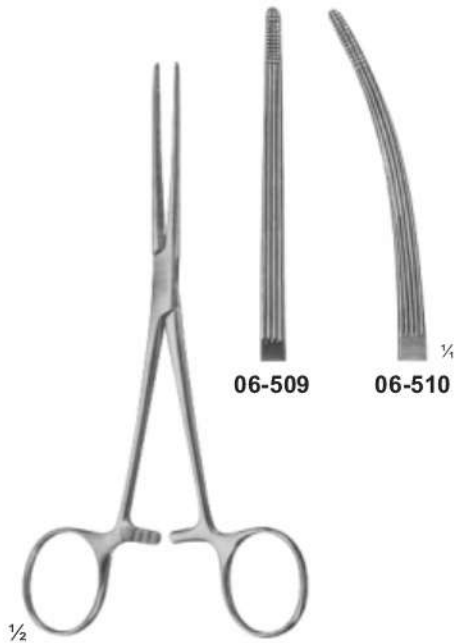
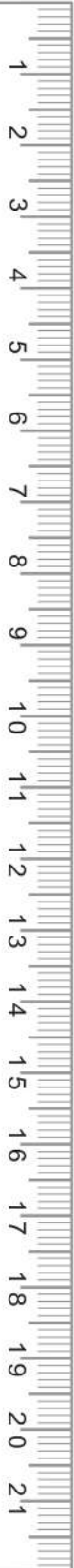

**06-509 - 510**  
**BAINBRIDGE**  
 155 mm



**06-511**  
**ALLEN**  
 155 mm

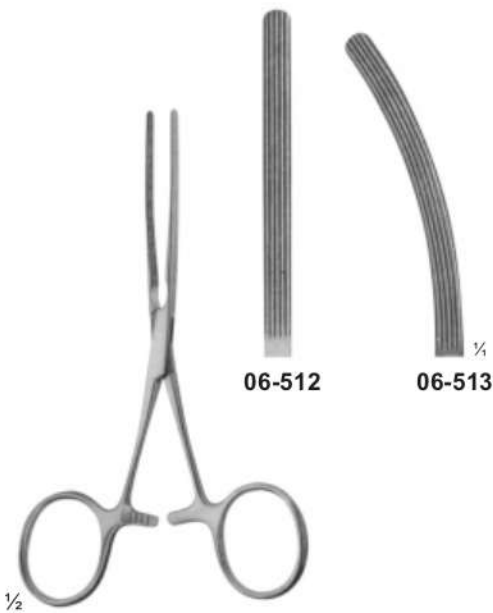

**06-512 - 513**  
**BABY-KOCHER**  
 very elastic blades  
 130 mm

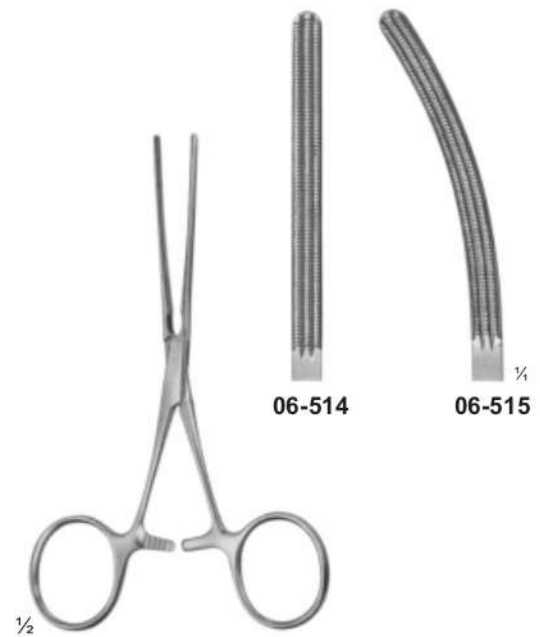

**06-514 - 515**  
**BABY-KOCHER**  
 with elastic blades  
 130 mm





**Intestinal Clamps, Soft Elastic**  
**Darmklammern, Weichen, Elastischen**  
**Abrazaderas Intestinales, Blando Y Elástico**

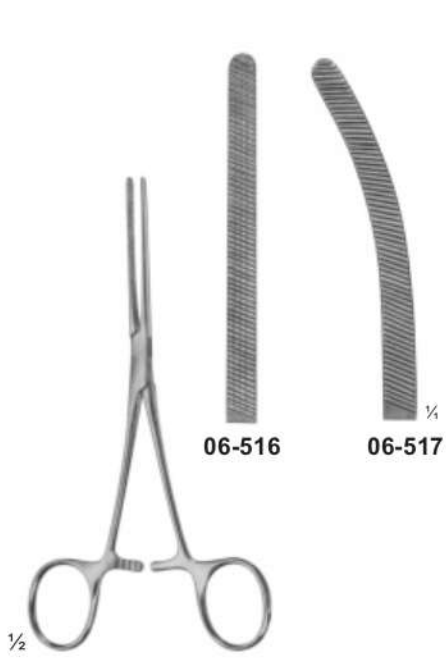

**06-516 - 517**  
DOYEN  
elastic  
165 mm

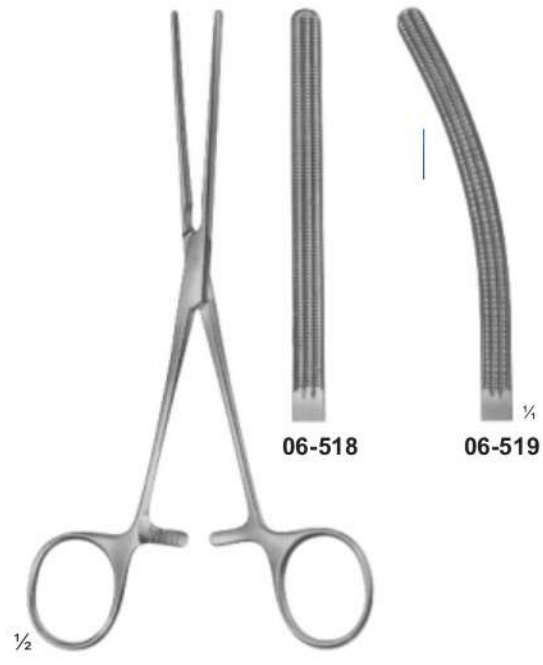

**06-518 - 519**  
DOYEN  
with elastic blades  
170 mm

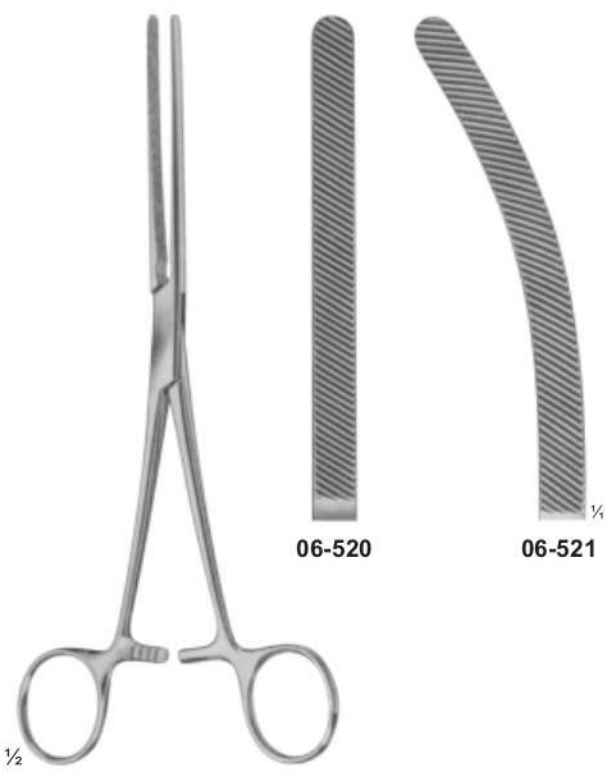

**06-520 - 521**  
HARTMANN  
with elastic blades  
200 mm

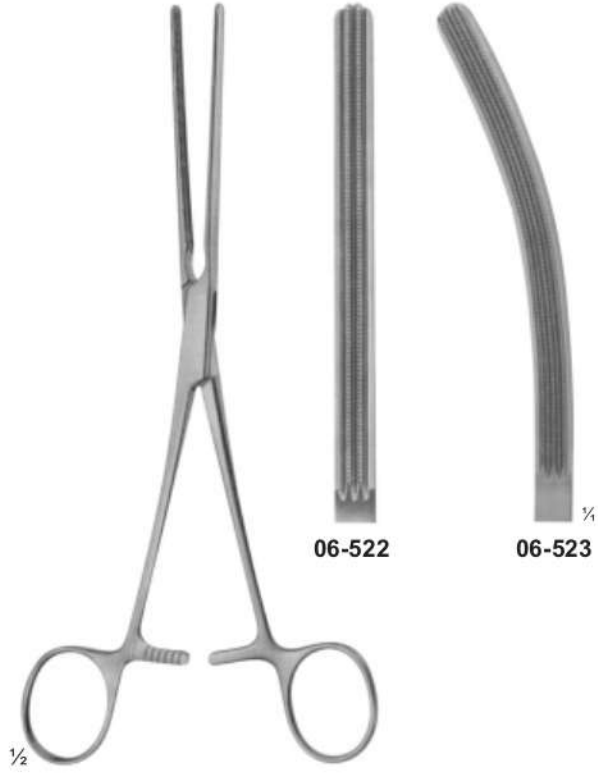

**06-522 - 523**  
HARTMANN  
with elastic blades  
200 mm

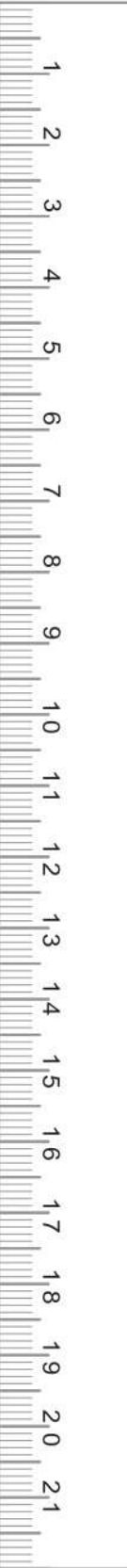

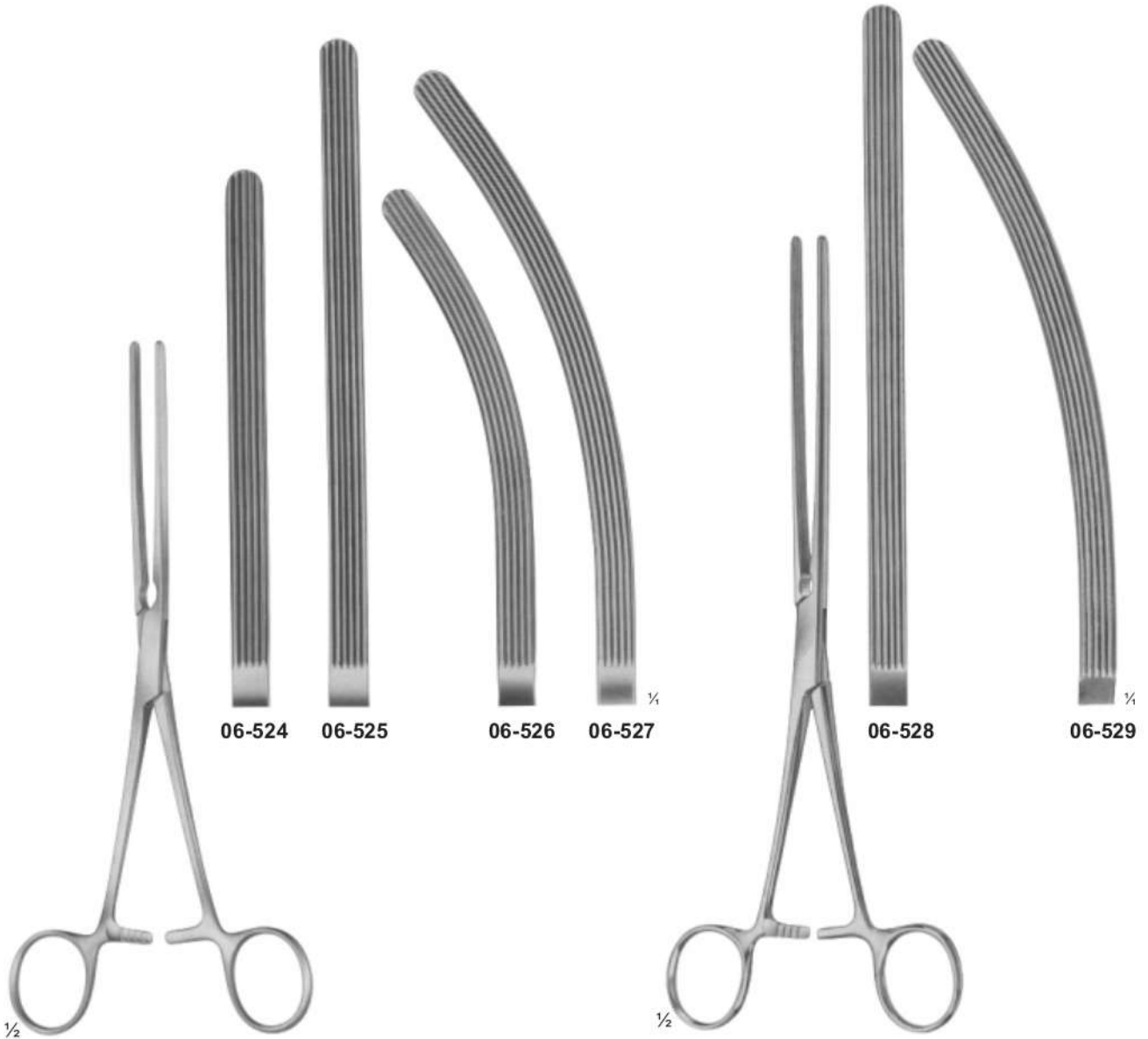
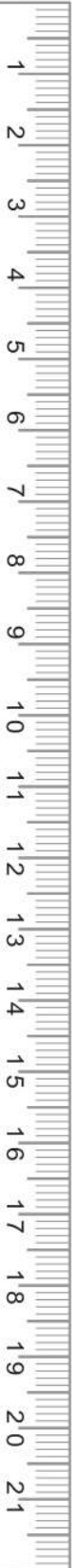

**06-524 - 527**  
KOCHER  
with elastic blades  
**06-526** 210 mm  
**06-527** 230 mm

**06-528 - 529**  
DOYEN  
with elastic blades  
210 mm



**Intestinal Clamps, Soft Elastic**  
Darmklammern, Weichen, Elastischen  
Abrazaderas Intestinales, Blando Y Elástico

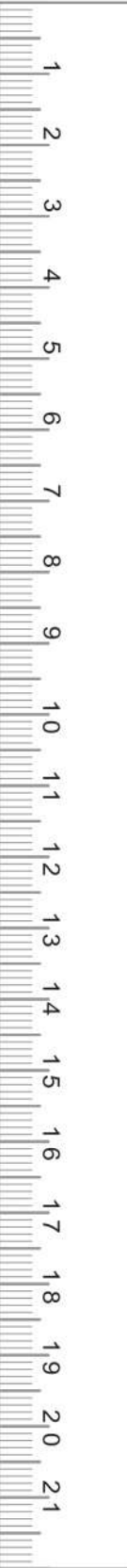
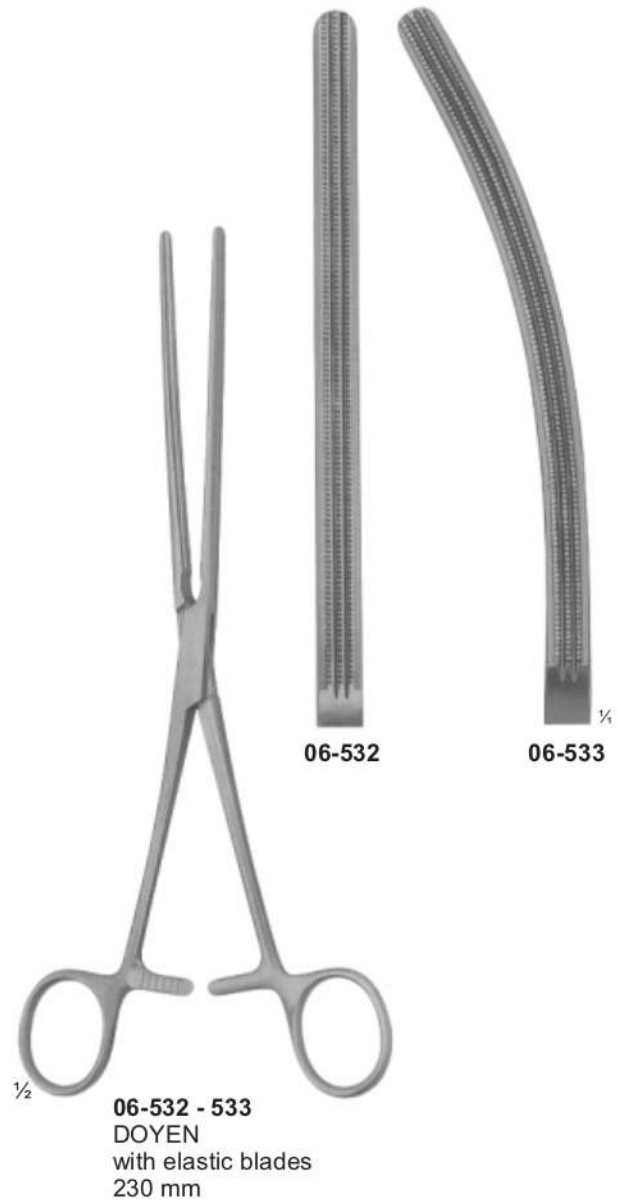

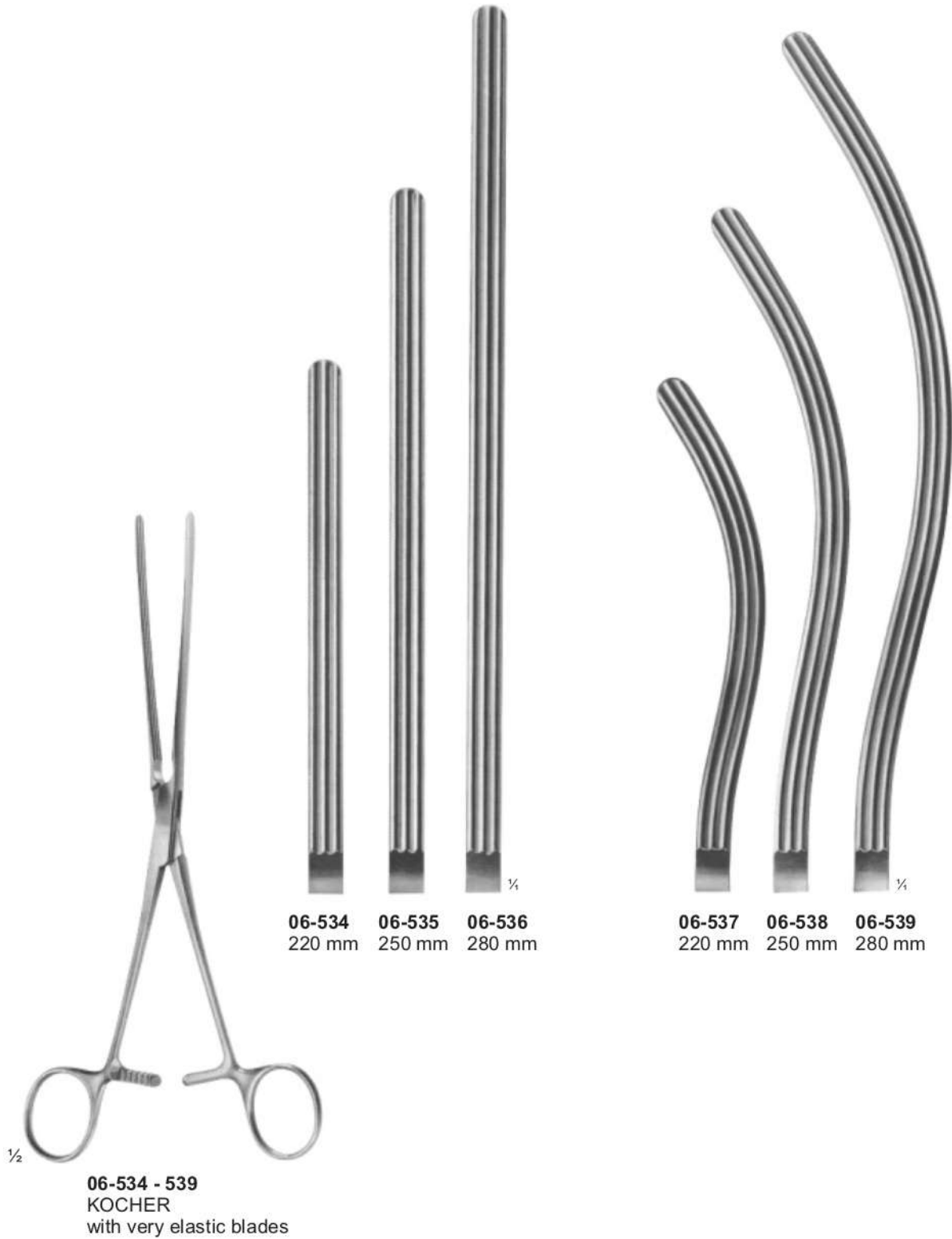
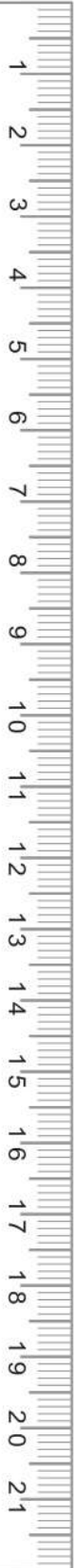

**Intestinal Clamps**  
Darmklammern  
Abrazaderas Intestinales

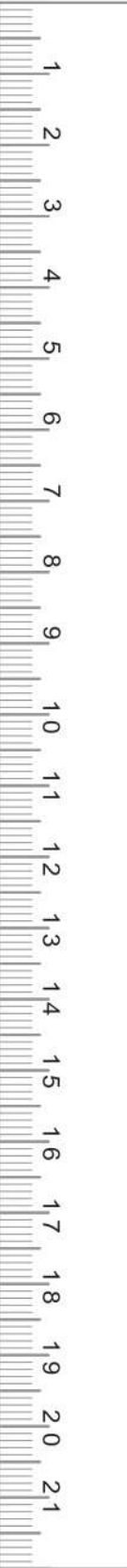
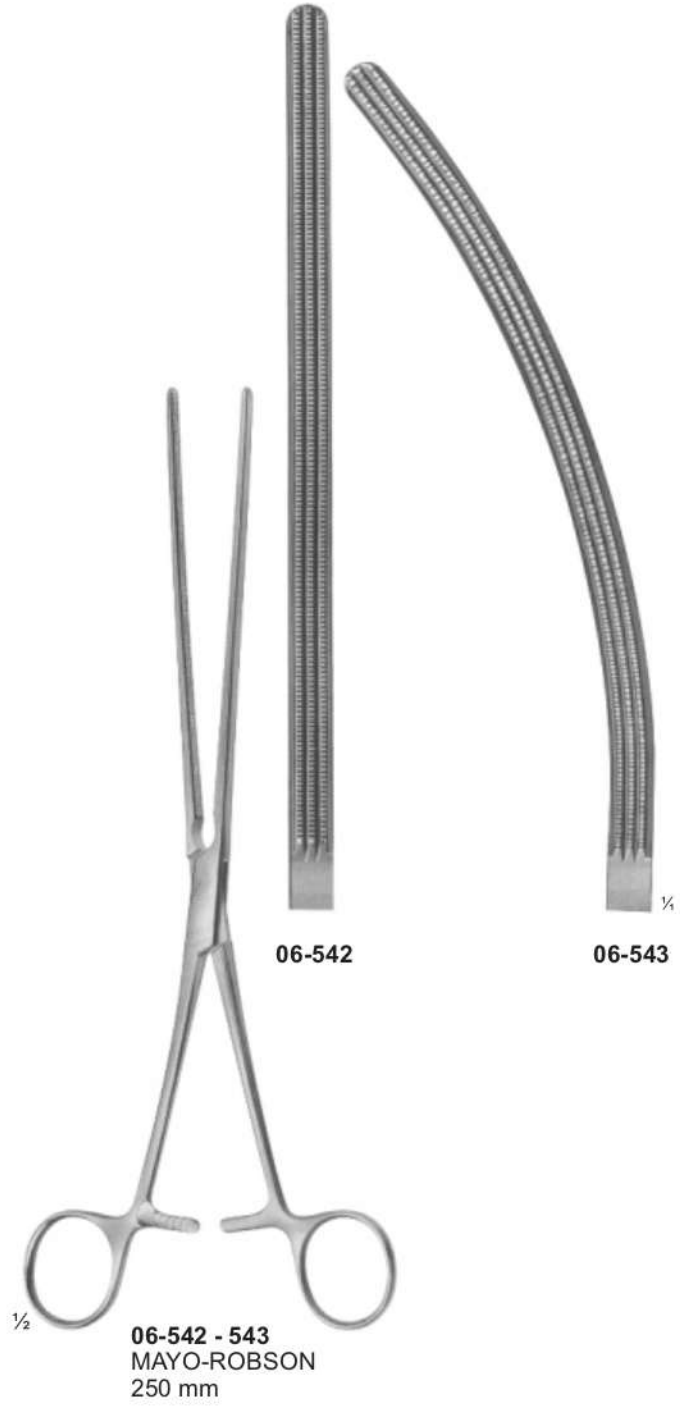



**Intestinal And Pylorus Clamps**  
Darm-und Pylorus Schellen  
Pinzas Intestinales Y El Píloro



**06-547**  
PAYR  
Intestinal clamp  
light pattern,  
for children  
180 mm

**06-548**  
PAYR  
200 mm

**06-549**  
PAYR  
275 mm

**06-550**  
PAYR  
Pylorus clamp  
315 mm

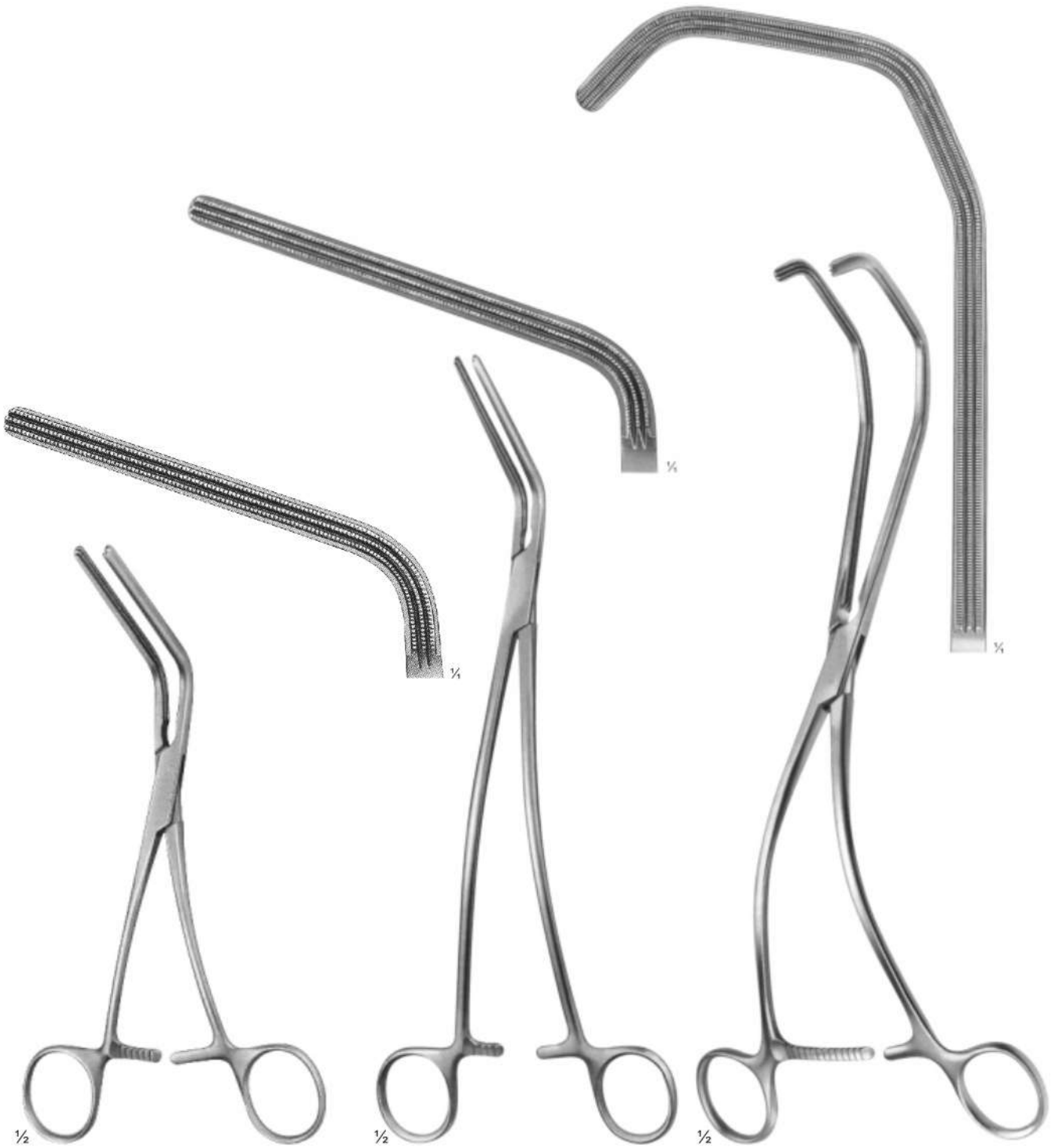
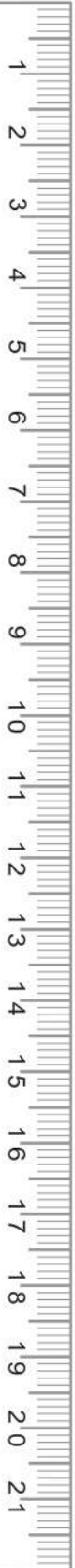

$\frac{1}{2}$   
**06-551  
MORRIS  
175 mm**

$\frac{1}{2}$   
**06-552  
DE BAKEY  
(MORRIS modif.)  
240 mm**

$\frac{1}{2}$   
**06-553  
KERSTING  
270 mm**

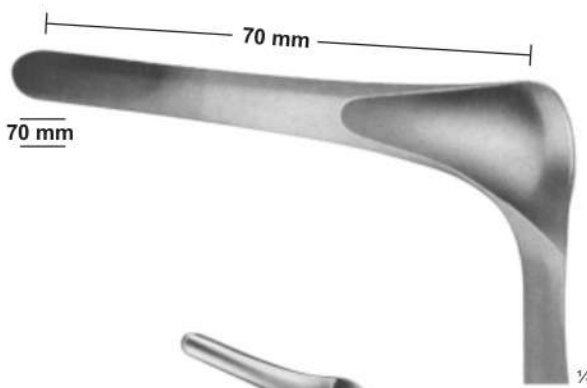

1/2

**06-554**  
 KILLIAN  
 for children  
 145 mm



1/2

**06-555**  
 SIMS  
 160 mm



1/2

**06-556**  
 SIMS  
 160 mm

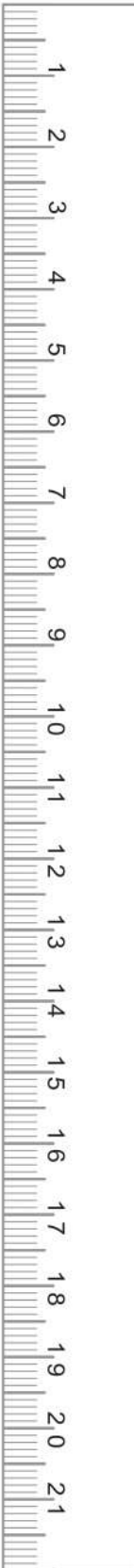



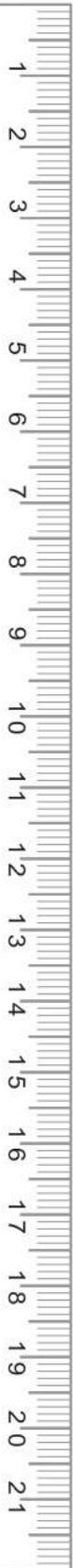

**06-557**  
SIMS  
for children  
190 mm

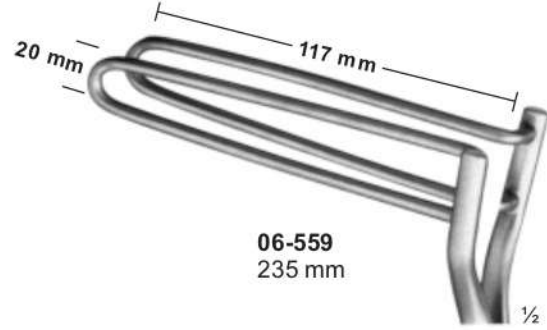

**06-559**  
235 mm

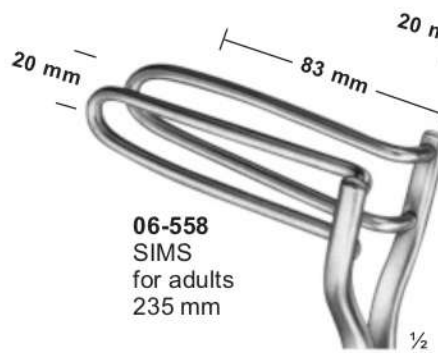

**06-558**  
SIMS  
for adults  
235 mm

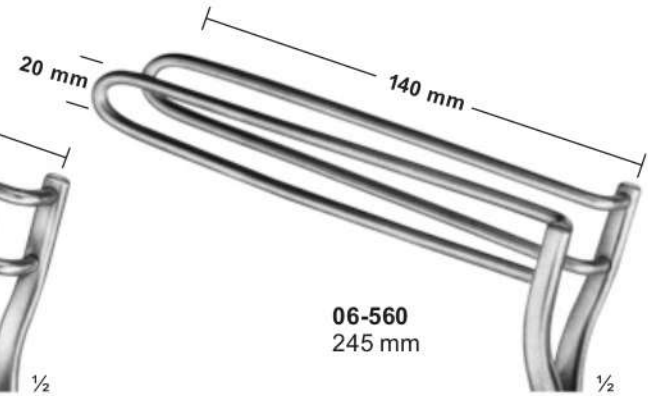

**06-560**  
245 mm



**06-561**  
PRATT  
205 mm

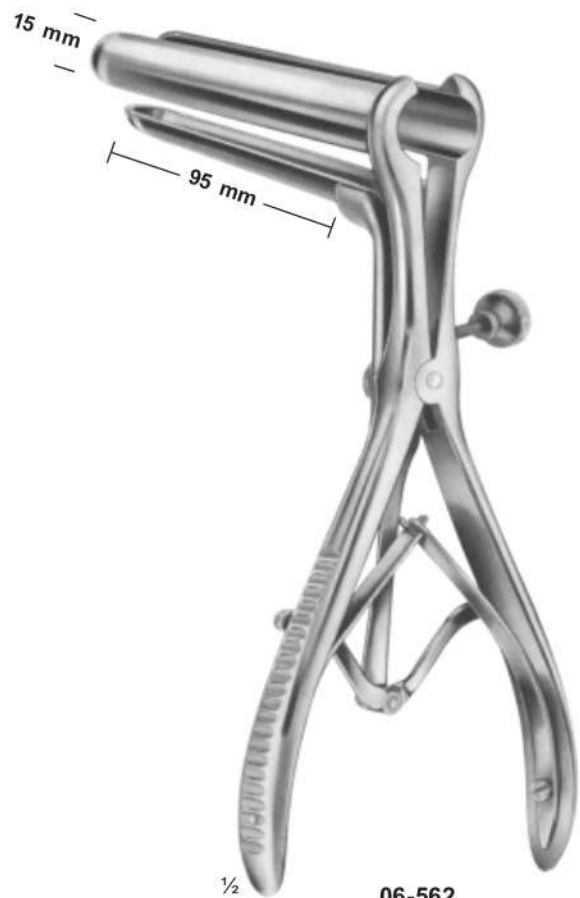

**06-562**  
MATHIEU  
215 mm



**06-563**  
 IVES-FANSLER  
 Anuscope  
 145 mm

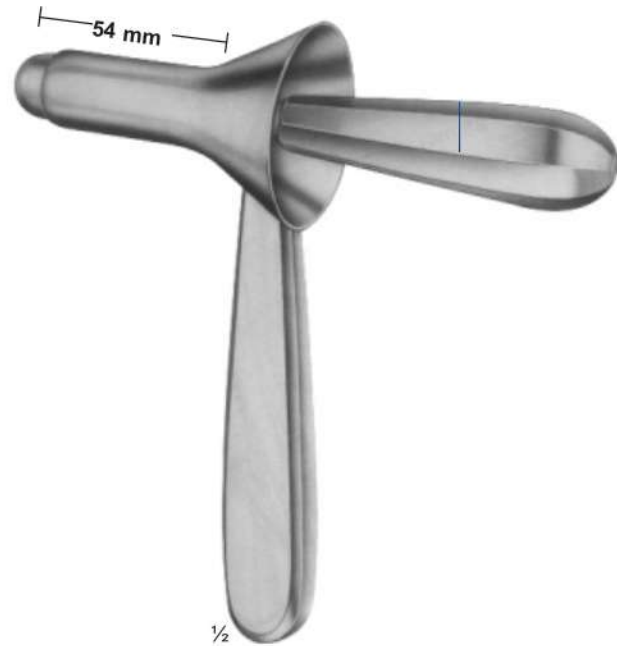

**06-564**  
 KELLY  
 Sphincteroscope  
 160 mm

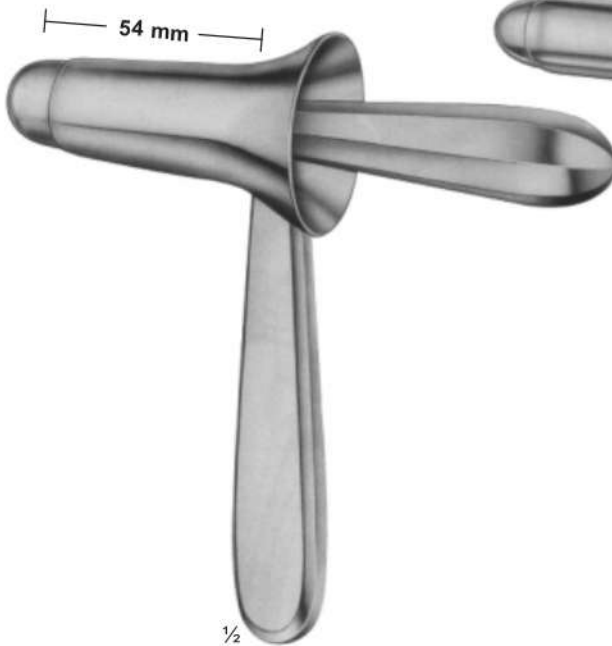

**06-565**  
 KELLY  
 Sphincteroscope  
 160 mm

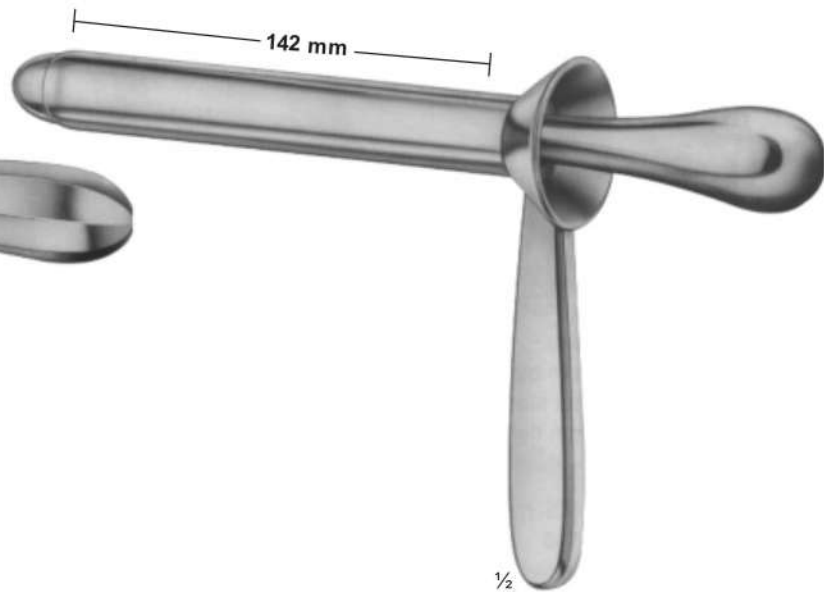

**06-566**  
 KELLY  
 Proctoscope  
 160 mm

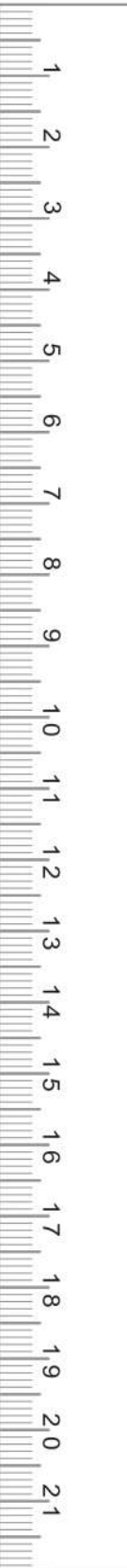

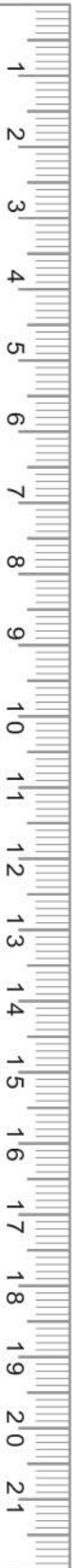

385 mm

06-567

5,8 mm

420 mm

06-568  
YEOMAN

4,0 mm

420 mm

06-569  
HERGET

3,5 mm

With Drawing Cut

240 mm  
400 mm

06-570  
Turnable  
240 mm

06-571  
Turnable  
400 mm

3,8 mm



**Gall Duct Forceps**  
Gallenwegefunktionsstörungen Zange  
Pinzas De Conductos Biliares



**06-572**  
LOWER  
180 mm



**06-573**  
LAHEY ( SWEET )  
190 mm



**06-574**  
LAHEY  
220 mm



**06-575**  
DESJARDINS  
Gall duct-and cystic forceps  
210 mm



**06-576**  
NISSEN  
Gall duct-and cystic forceps  
215 mm

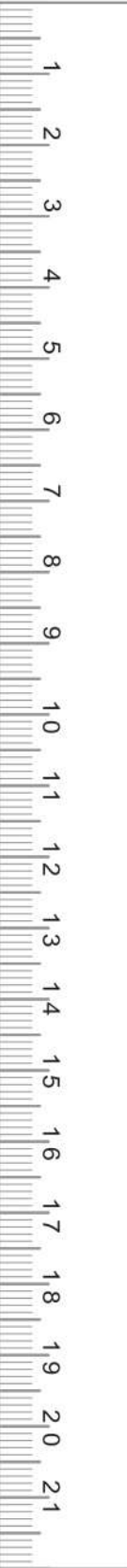

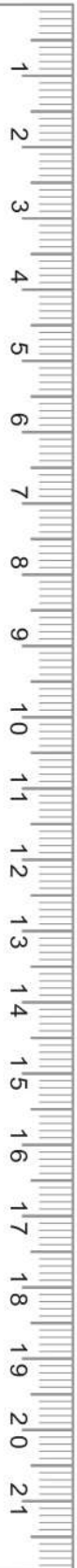

**06-577 - 578**  
 GRAY  
 180 mm

06-577

06-578  $\frac{1}{4}$



**06-579 - 580**  
 MIXTER  
 Gall duct-and cystic forceps  
 230 mm

06-579  $\frac{1}{4}$

06-580  $\frac{1}{4}$



**06-581**  
 FOERSTER-BALLENGER  
 240 mm

06-581  $\frac{1}{4}$

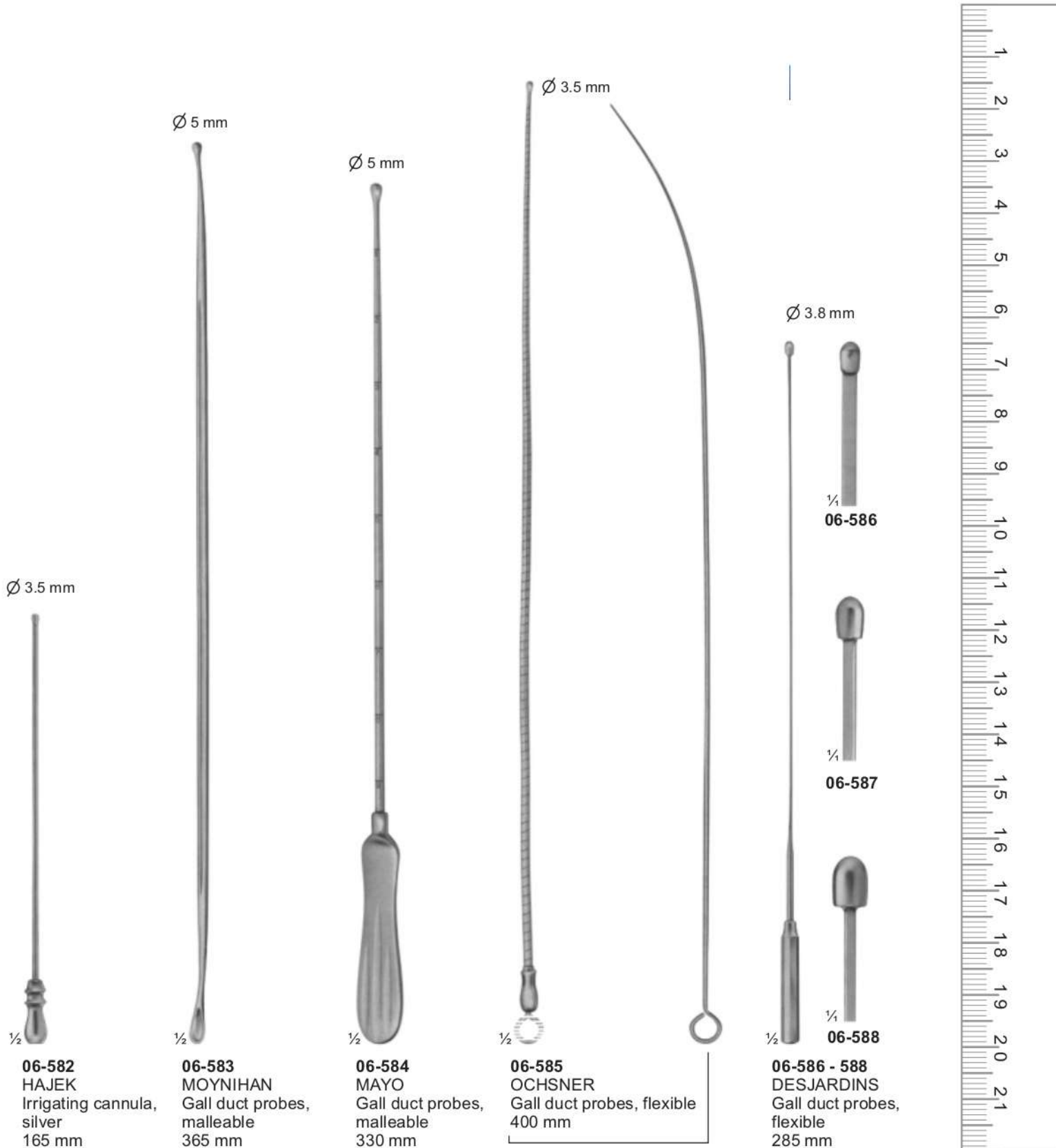

Ø 3.5 mm

Ø 5 mm

Ø 5 mm

Ø 3.5 mm

Ø 3.8 mm

1/2

1/2

1/2

1/2

1/2

1/4

1/4

1/4

**06-582**  
 HAJEK  
 Irrigating cannula,  
 silver  
 165 mm

**06-583**  
 MOYNIHAN  
 Gall duct probes,  
 malleable  
 365 mm

**06-584**  
 MAYO  
 Gall duct probes,  
 malleable  
 330 mm

**06-585**  
 OCHSNER  
 Gall duct probes, flexible  
 400 mm

**06-586 - 588**  
 DESJARDINS  
 Gall duct probes,  
 flexible  
 285 mm

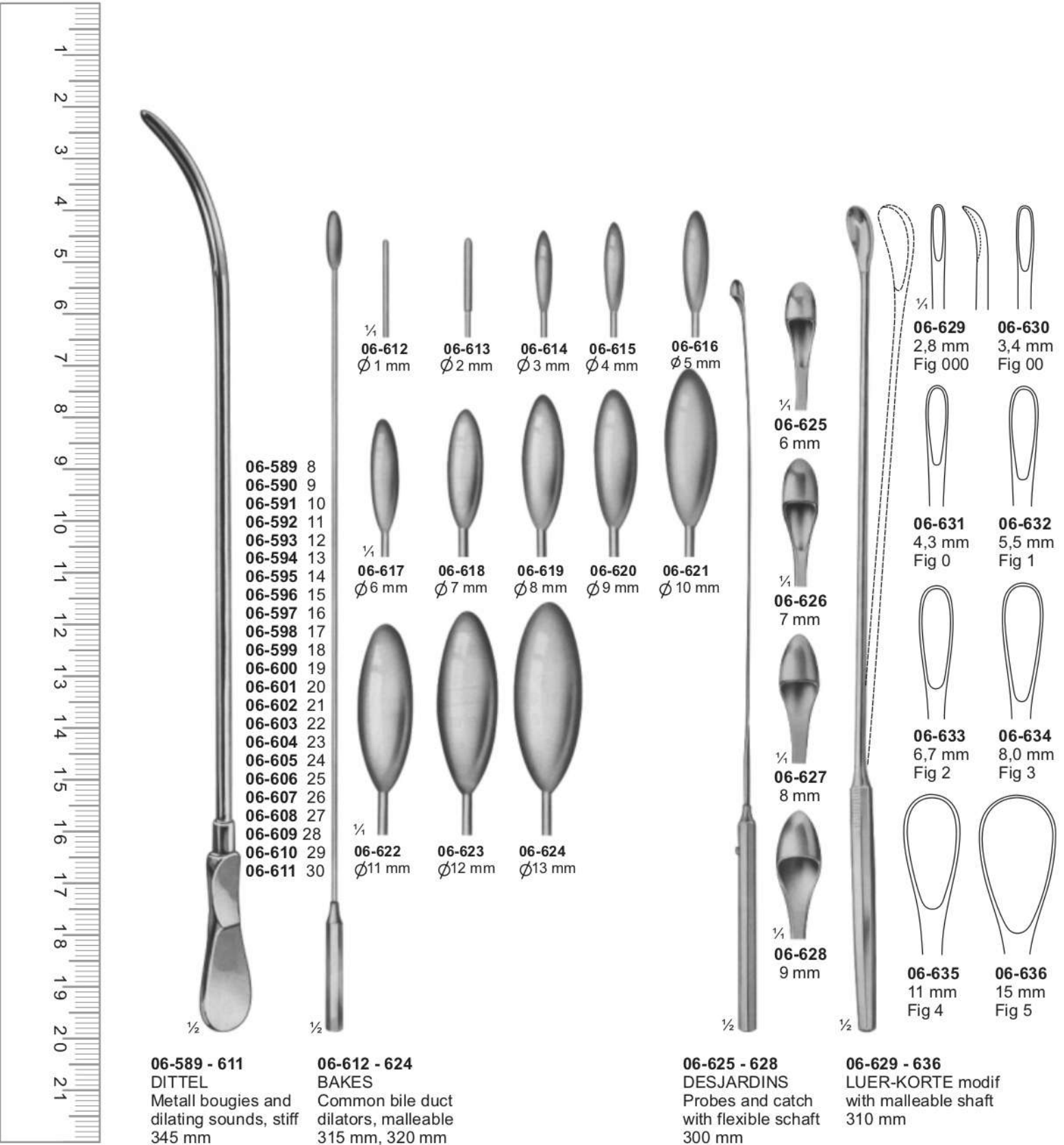

**06-589 - 611**  
**DITTEL**  
 Metall bougies and dilating sounds, stiff  
 345 mm

**06-612 - 624**  
**BAKES**  
 Common bile duct dilators, malleable  
 315 mm, 320 mm

**06-612**  $\frac{1}{4}$   
 $\varnothing$  1 mm

**06-613**  $\frac{1}{4}$   
 $\varnothing$  2 mm

**06-614**  $\frac{1}{4}$   
 $\varnothing$  3 mm

**06-615**  $\frac{1}{4}$   
 $\varnothing$  4 mm

**06-616**  $\frac{1}{4}$   
 $\varnothing$  5 mm

**06-617**  $\frac{1}{4}$   
 $\varnothing$  6 mm

**06-618**  $\frac{1}{4}$   
 $\varnothing$  7 mm

**06-619**  $\frac{1}{4}$   
 $\varnothing$  8 mm

**06-620**  $\frac{1}{4}$   
 $\varnothing$  9 mm

**06-621**  $\frac{1}{4}$   
 $\varnothing$  10 mm

**06-622**  $\frac{1}{4}$   
 $\varnothing$  11 mm

**06-623**  $\frac{1}{4}$   
 $\varnothing$  12 mm

**06-624**  $\frac{1}{4}$   
 $\varnothing$  13 mm

**06-625 - 628**  
**DESJARDINS**  
 Probes and catch with flexible shaft  
 300 mm

**06-625**  $\frac{1}{4}$   
 6 mm

**06-626**  $\frac{1}{4}$   
 7 mm

**06-627**  $\frac{1}{4}$   
 8 mm

**06-628**  $\frac{1}{4}$   
 9 mm

**06-629 - 636**  
**LUER-KORTE modif**  
 with malleable shaft  
 310 mm

**06-629**  $\frac{1}{4}$   
 2,8 mm  
 Fig 000

**06-630**  $\frac{1}{4}$   
 3,4 mm  
 Fig 00

**06-631**  $\frac{1}{4}$   
 4,3 mm  
 Fig 0

**06-632**  $\frac{1}{4}$   
 5,5 mm  
 Fig 1

**06-633**  $\frac{1}{4}$   
 6,7 mm  
 Fig 2

**06-634**  $\frac{1}{4}$   
 8,0 mm  
 Fig 3

**06-635**  $\frac{1}{4}$   
 11 mm  
 Fig 4

**06-636**  $\frac{1}{4}$   
 15 mm  
 Fig 5

**Gall Stone Forceps**  
**Gallenstein Zange**  
**Pinzas De Cálculos Biliares**



**06-637  
 BLAKE  
 205 mm**

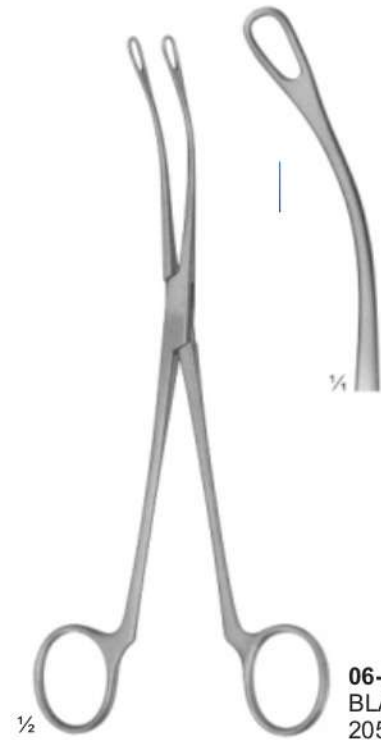

**06-638  
 BLAKE  
 205 mm**

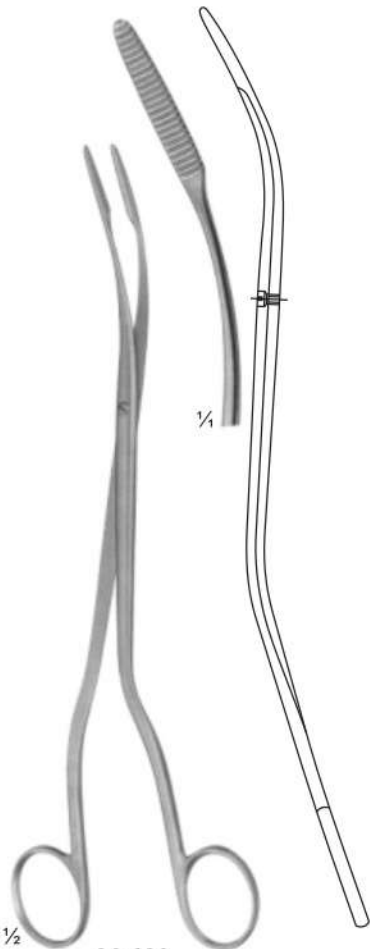

**06-639  
 CZERNY  
 245 mm**

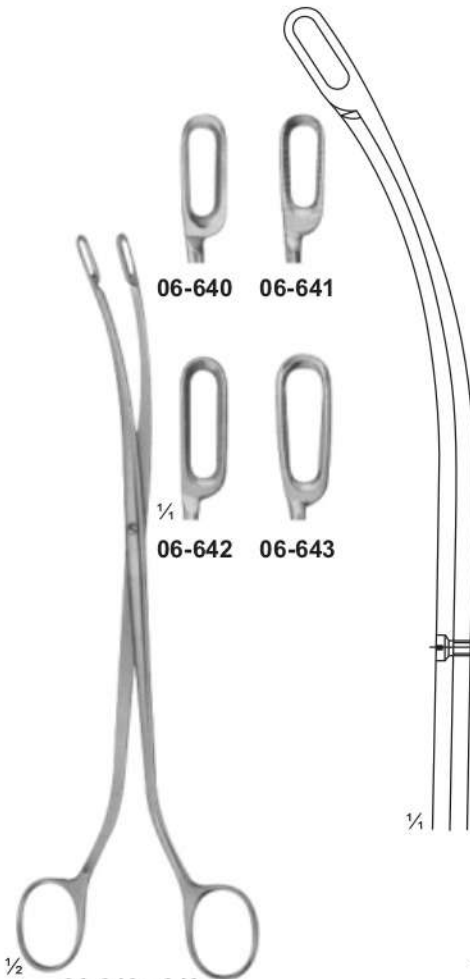

**06-640 - 643  
 DESJARDINS  
 225 mm**

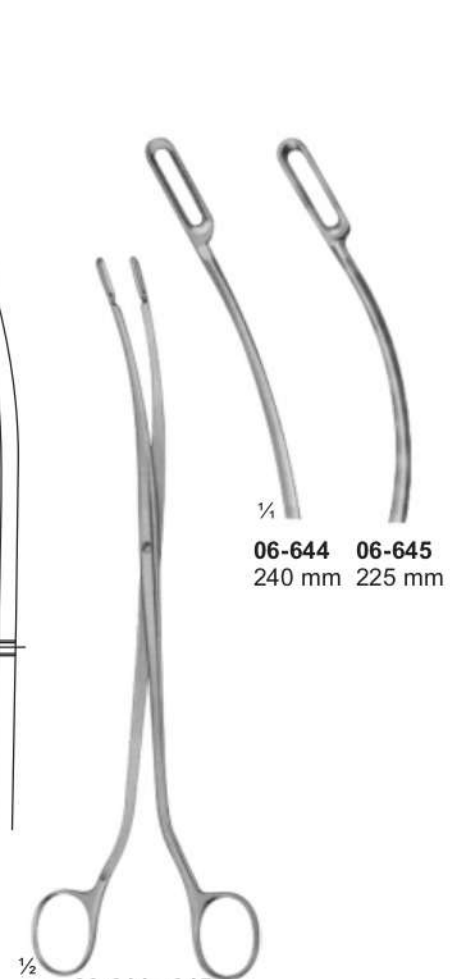

**06-644 - 645  
 DESJARDINS  
 Extremely delicate patterns**

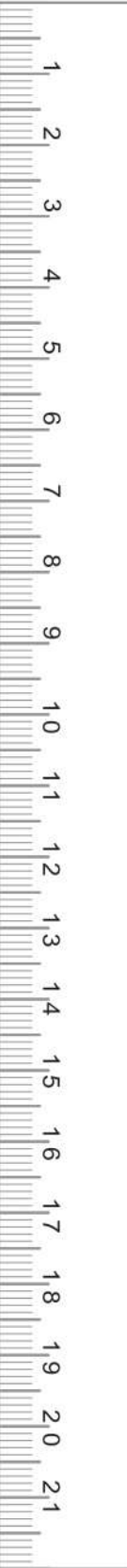



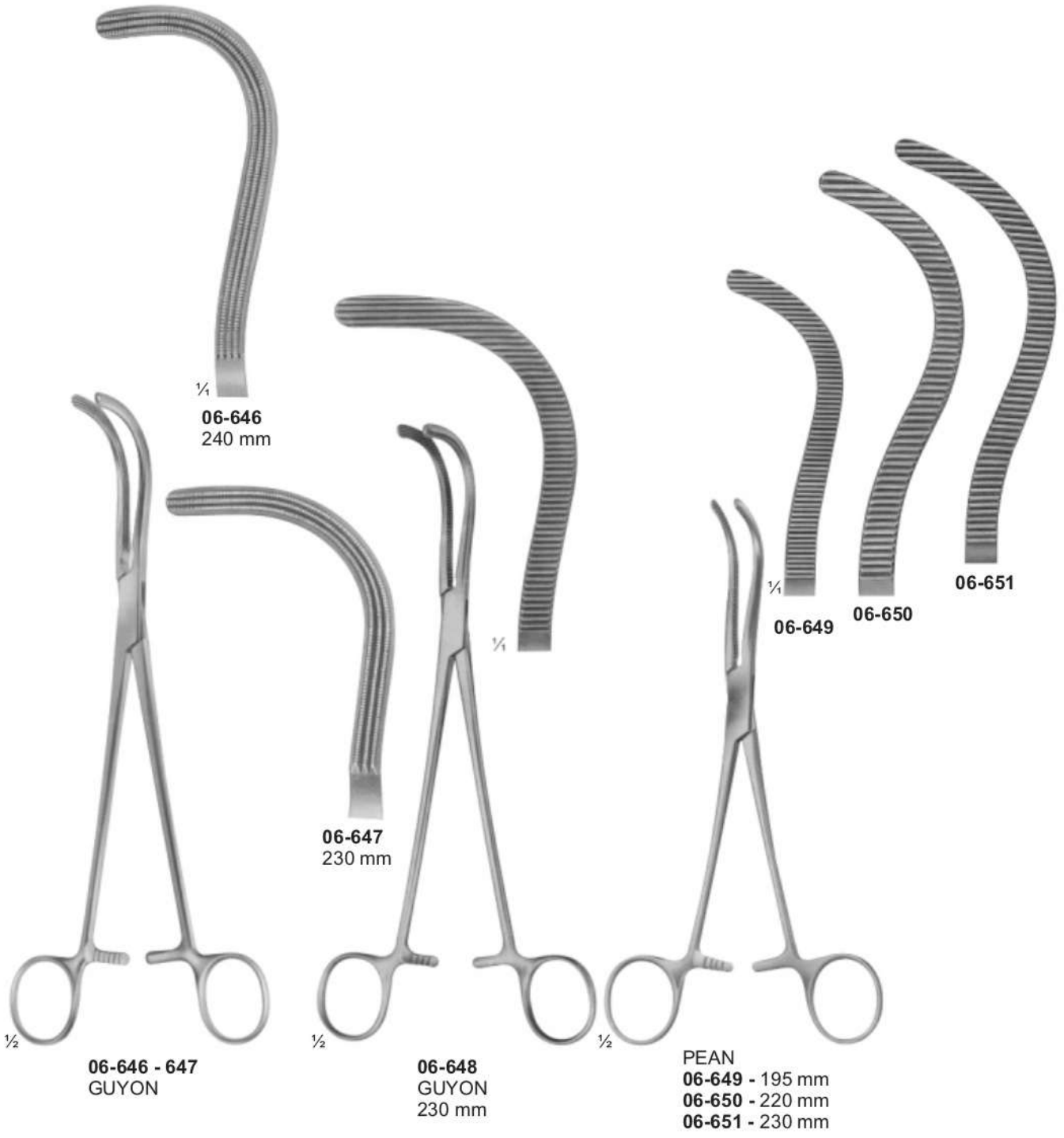
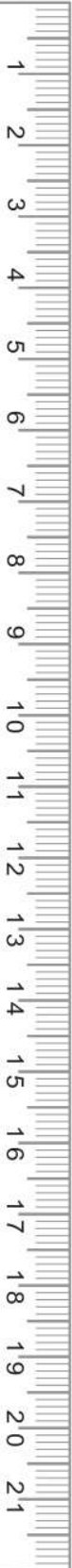

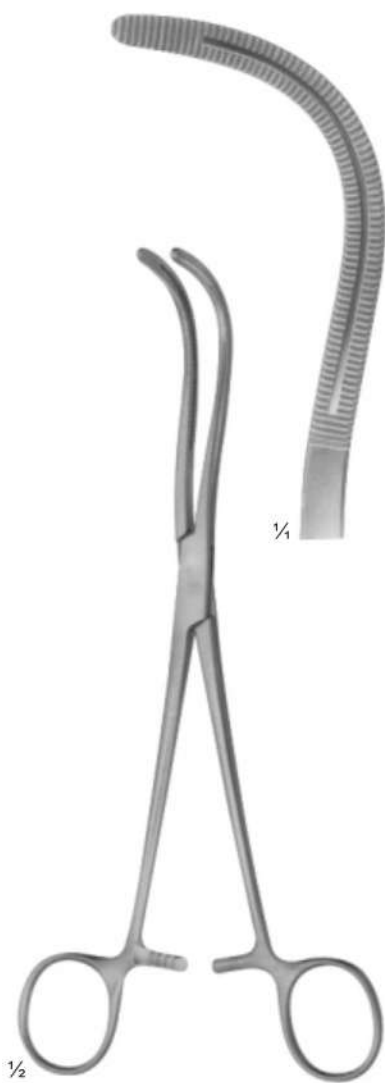

**06-652**  
STILLE  
220 mm

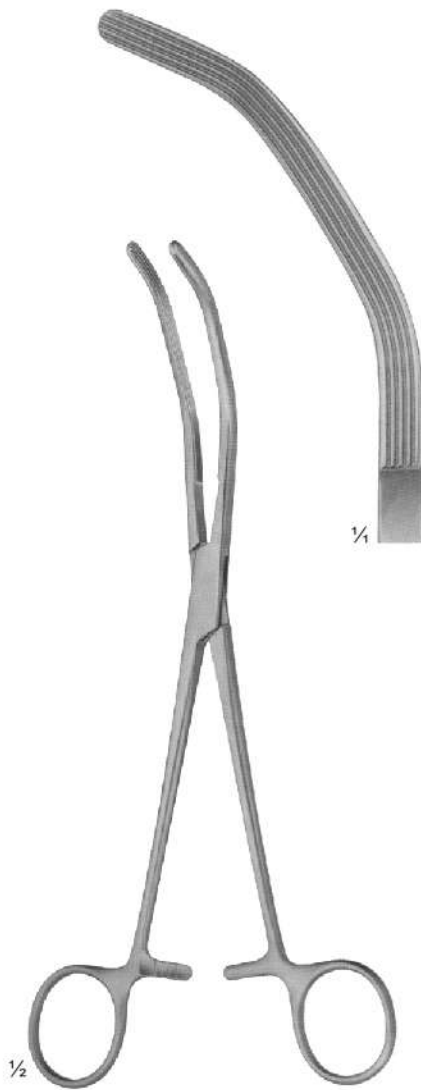

**06-653**  
HERRICK  
225 mm

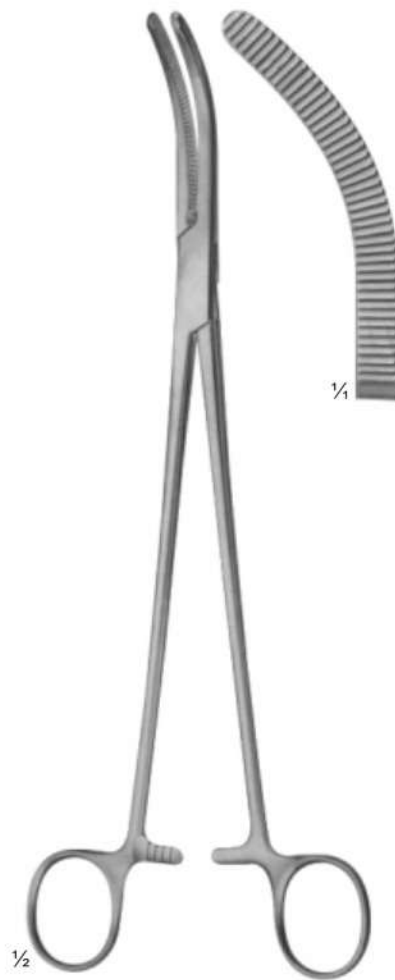

**06-654**  
WERTHEIM  
225 mm

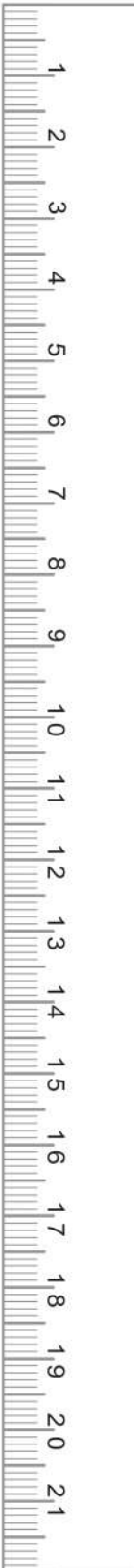



06-655



06-656



06-657



1/4  
06-658



1/2

**06-655 - 658**  
RANDALL  
225 mm



06-659



06-660



1/4  
06-661



1/2

**06-659 - 661**  
RANDALL  
190 mm

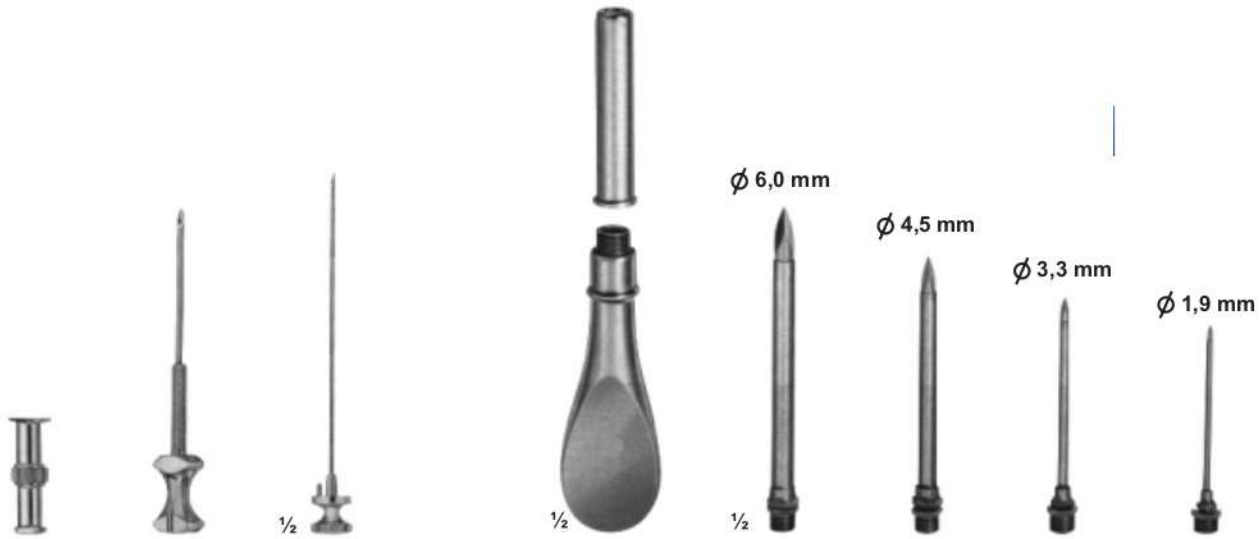

**06-662**  
KLIMA ROSEGGER  
35 X 1,8 mm  
Sternal puncture needle

**06-663**  
Universal trocar  
with 4 tips



**06-664 - 668**  
Inside dime. Outside dime  
**06-664** 2,2 mm 3,0 mm  
**06-665** 3,0 mm 4,0 mm  
**06-666** 4,0 mm 5,0 mm  
**06-667** 5,0 mm 6,0 mm  
**06-668** 5,5 mm 6,5 mm  
for hydrocele and abdominal  
puncture



**06-669 - 672**  
Inside dime. Outside dime  
**06-669** 2,2 mm 3,0 mm  
**06-670** 3,0 mm 4,0 mm  
**06-671** 4,0 mm 5,0 mm  
**06-672** 5,0 mm 6,0 mm  
for abdominal puncture,  
with stop-cock and lateral  
drain

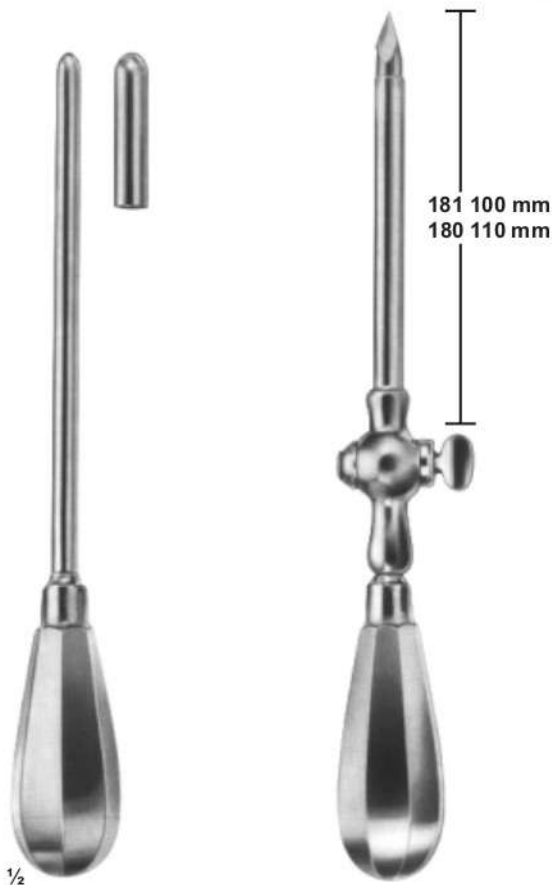

**06-673 - 674**  
Inside dime. Outside dime  
**06-673** 6,5 mm 8,0 mm  
**06-674** 9,0 mm 10,0 mm  
Empyema trocar



**06-675 - 678**  
Inside dime. Outside dime  
**06-675** 3,0 mm 4,0 mm  
**06-676** 3,6 mm 4,6 mm  
**06-677** 4,3 mm 5,3 mm  
**06-678** 5,0 mm 6,0 mm  
Gall bladder trocars



**06-679**  
PIERCE  
Antrum trocar  
4,0 mm



**06-680**  
COAKLEY  
Antrum trocar  
3,0 mm

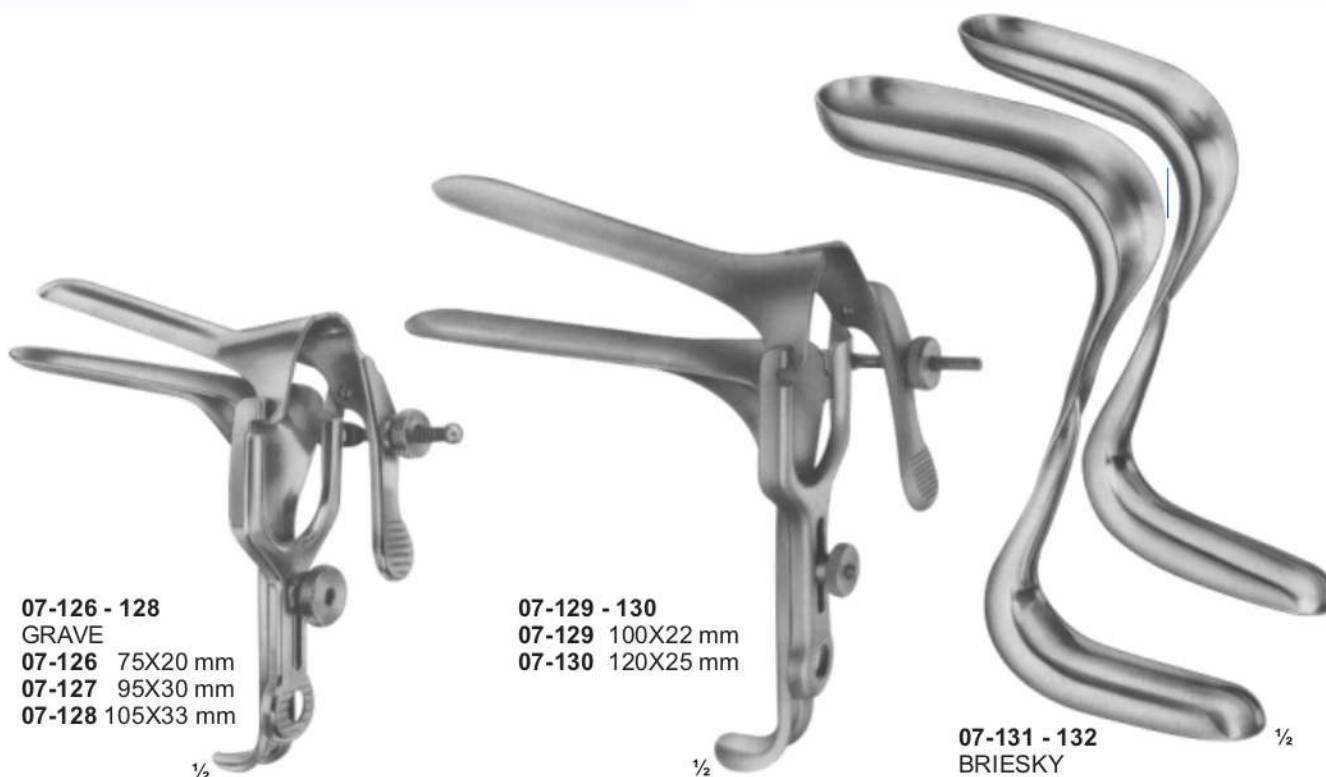

**07-126 - 128**  
 GRAVE  
 07-126 75X20 mm  
 07-127 95X30 mm  
 07-128 105X33 mm

**07-129 - 130**  
 07-129 100X22 mm  
 07-130 120X25 mm

**07-131 - 132**  
 BRIESKY  
 07-131 72X25 mm / 77X30 mm  
 07-132 75X30 mm / 92X38 mm  
 170 mm

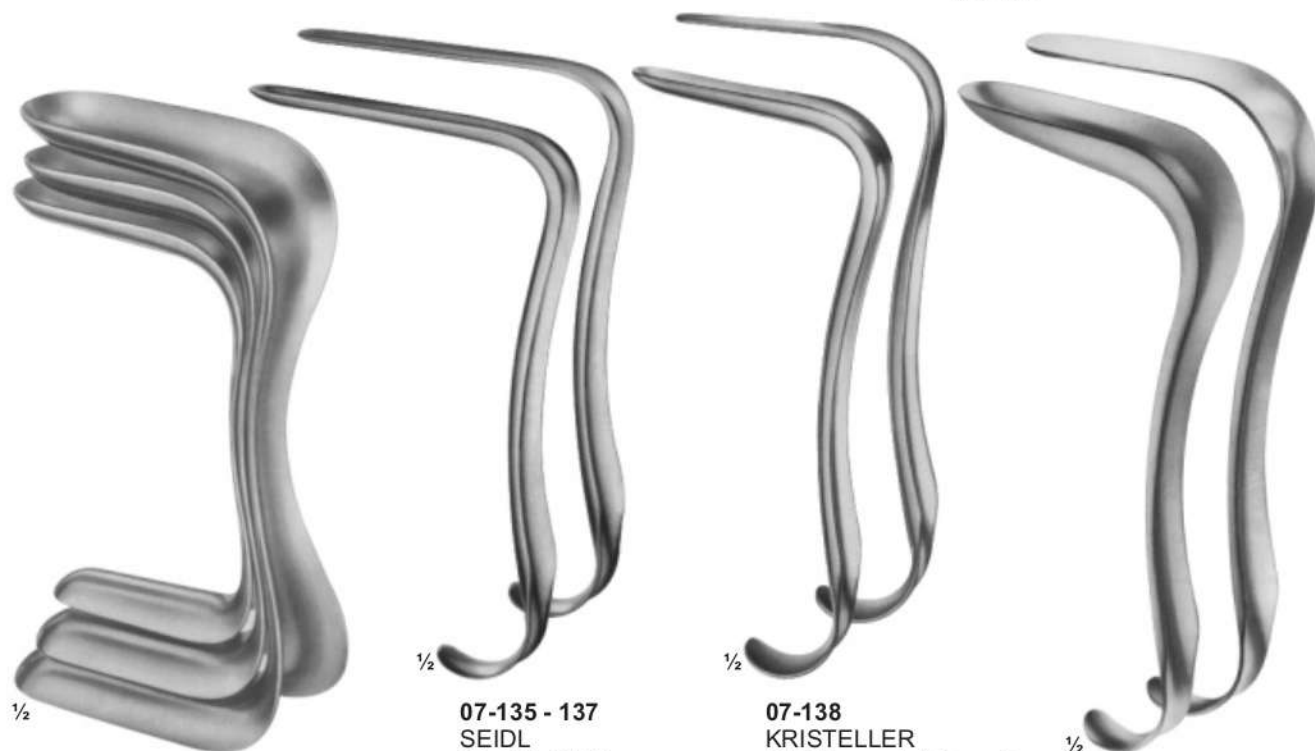

**07-133 - 134**  
 BREISKY  
 07-133 100X22 mm  
 77 X30 mm  
 140 mm

**07-134**  
 120X25 mm  
 92 X38 mm  
 170 mm

**07-135 - 137**  
 SEIDL  
 07-135 80X8 mm  
 07-136 80X10 mm  
 07-137 90X14 mm  
 For children and infants  
 170 mm

**07-138**  
 KRISTELLER  
 70X15 mm, ( 170 mm )  
 For children

**07-139 - 141**  
 SIMS  
 07-139 70X26 mm  
 75 X30 mm 125 mm  
 07-140 75X30 mm  
 80 X85 mm 150 mm  
 07-141 80X36 mm  
 90 X40 mm 175 mm





**07-112 - 115**  
CUSCO  
STANDARD  
**07-112** 80X24 mm  
**07-113** 80X32 mm  
**07-114** 90X36 mm  
**07-115** 110X37 mm



**07-116 - 119**  
CUSCO  
**07-116** 80X24 mm  
**07-117** 80X32 mm  
**07-118** 90X36 mm  
**07-119** 110X37 mm



**07-120 - 122**  
CUSCO  
**07-120** 80X24 mm  
**07-121** 80X32 mm  
**07-122** 115X36 mm



**07-123 - 124**  
SEYFFERT  
**07-123** 100X24 mm  
**07-124** 110X32 mm  
230 mm



**07-125**  
SEMM  
for children  
and virgins  
180 mm

**Vaginal Speculums, Sets, Upper & Lower Blades**  
**Vaginal Spekulum, Sets, Oberer Und Unterer Blades**  
**Especulos Vaginales, Sets Superior E Inferior Hojas**

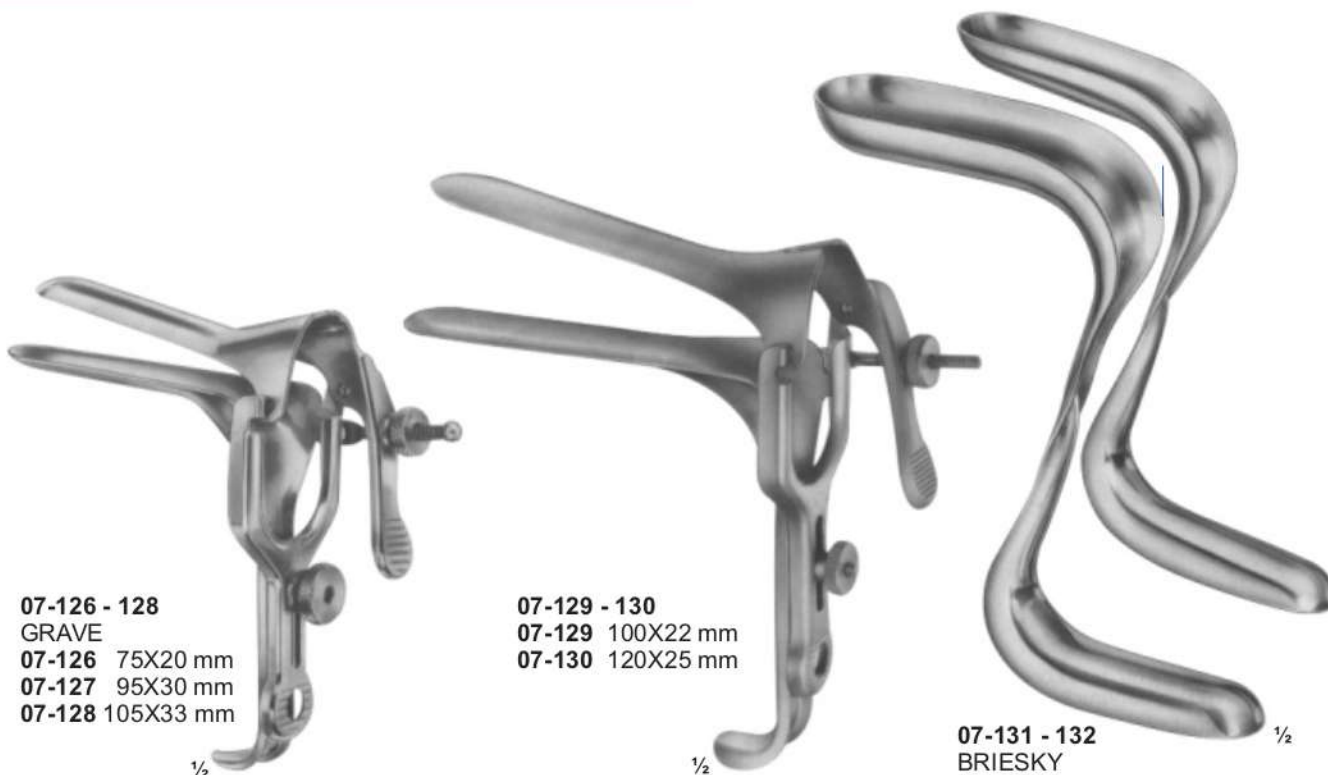

**07-126 - 128**  
**GRAVE**  
**07-126** 75X20 mm  
**07-127** 95X30 mm  
**07-128** 105X33 mm

**07-129 - 130**  
**07-129** 100X22 mm  
**07-130** 120X25 mm

**07-131 - 132**  
**BRIESKY**  
**07-131** 72X25 mm / 77X30 mm  
**07-132** 75X30 mm / 92X38 mm  
 170 mm

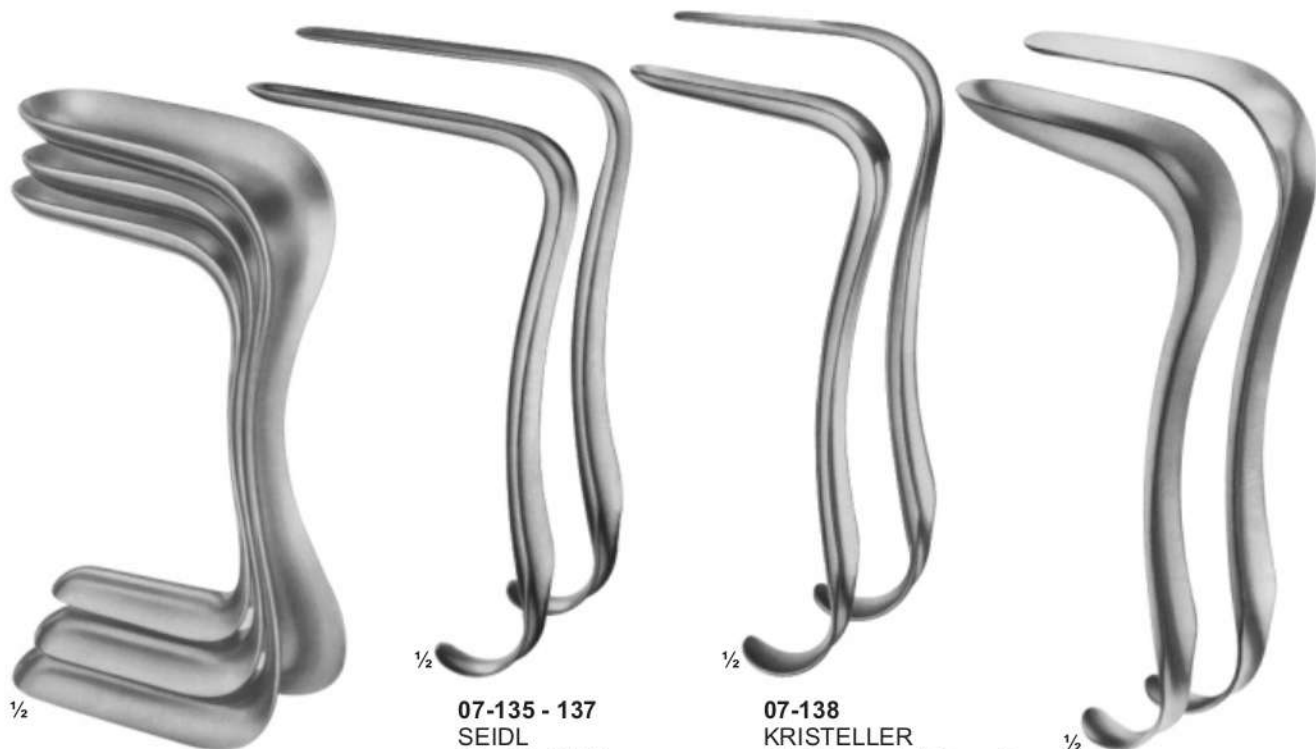

**07-133 - 134**  
**BREISKY**  
**07-133** 100X22 mm  
 77 X30 mm  
 140 mm

**07-134** 120X25 mm  
 92 X38 mm  
 170 mm

**07-135 - 137**  
**SEIDL**  
**07-135** 80X8 mm  
**07-136** 80X10 mm  
**07-137** 90X14 mm  
 For children and infants  
 170 mm

**07-138**  
**KRISTELLER**  
 70X15 mm, ( 170 mm )  
 For children

**07-139 - 141**  
**SIMS**  
**07-139** 70X26 mm  
 75 X30 mm 125 mm  
**07-140** 75X30 mm  
 80 X85 mm 150 mm  
**07-141** 80X36 mm  
 90 X40 mm 175 mm





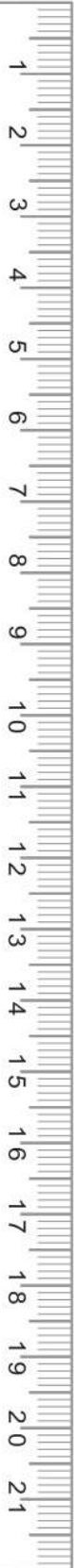

**07-142 - 146**  
**KRISTELLER**  
**07-142** 110X18 mm  
**07-143** 110X20 mm  
**07-144** 110X27 mm  
**07-145** 110X30 mm  
**07-146** 110X36 mm  
 220 mm

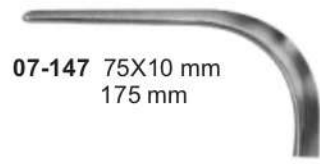

**07-147** 75X10 mm  
 175 mm



**07-148** 75X23 mm  
 180 mm



**07-149** 80X25 mm  
 180 mm



**07-150** 100X32 mm  
 185 mm



**07-147 - 150**  
**KRISTELLER**  
 Upper blades



**07-151** 70X15 mm  
 175 mm

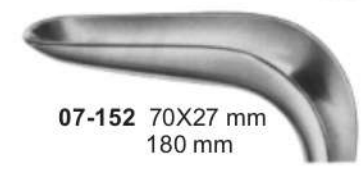

**07-152** 70X27 mm  
 180 mm

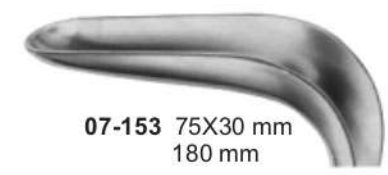

**07-153** 75X30 mm  
 180 mm



**07-154** 90X36 mm  
 185 mm



**07-151 - 154**  
**KRISTELLER**  
 Lower blades

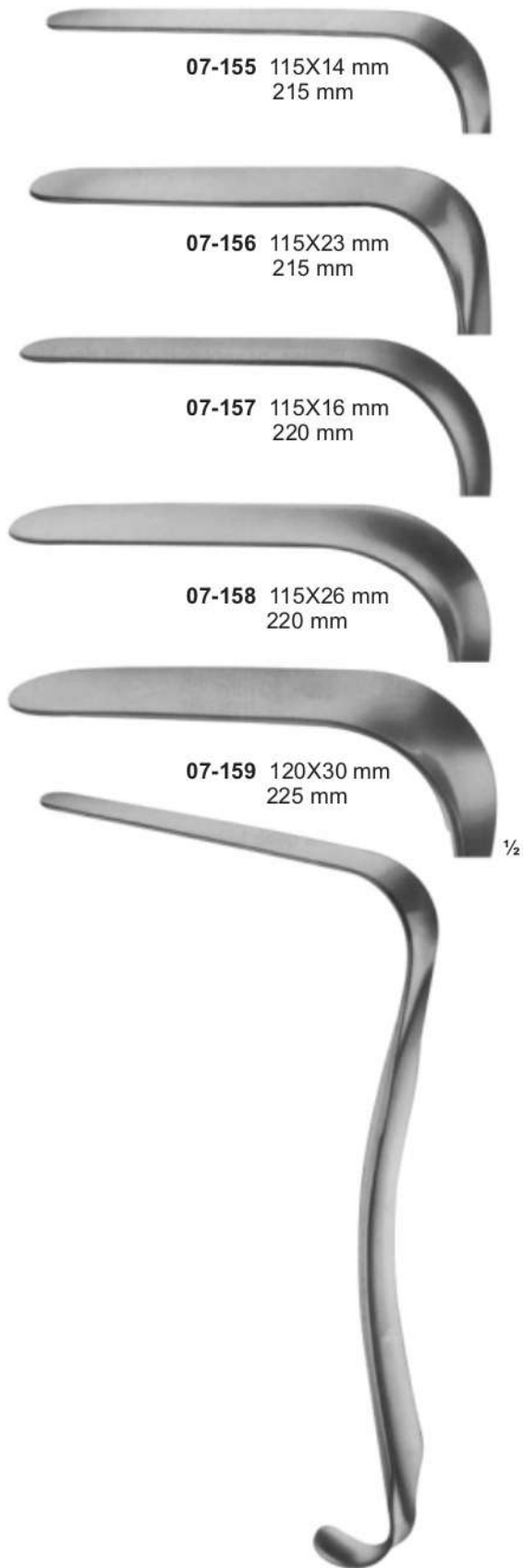

**07-155 - 159  
 KRISTELLER  
 Upper blades**

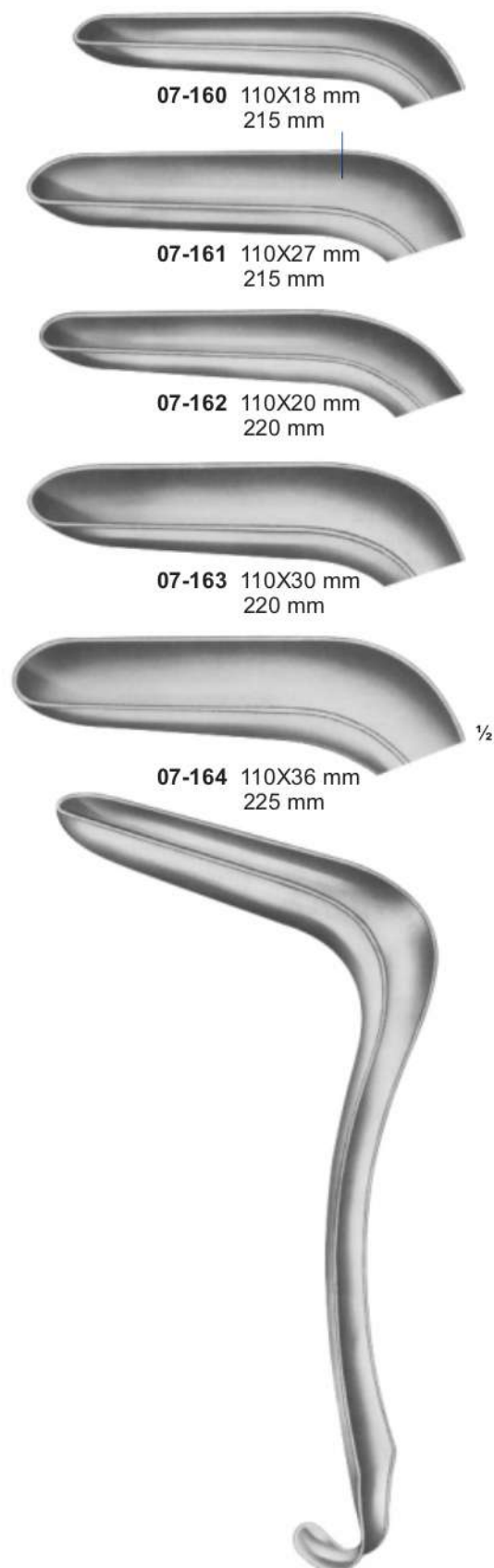

**07-160 - 164  
 KRISTELLER  
 Lower blades**

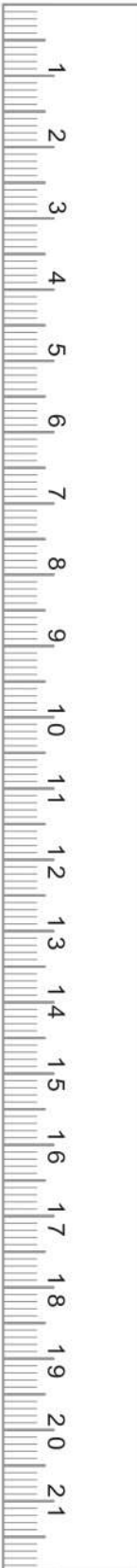

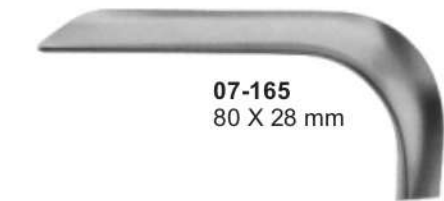

**07-165 - 167**  
KRISTELLER  
205 mm



**07-168 - 170**  
JACKSON  
175 mm

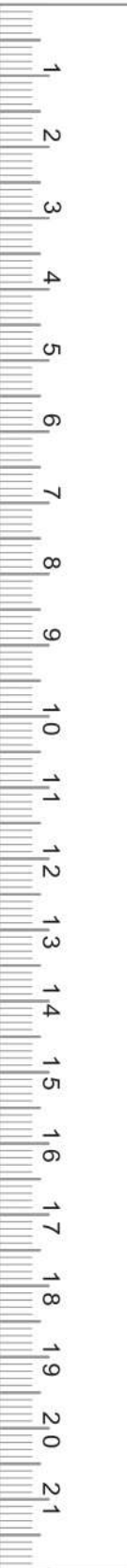

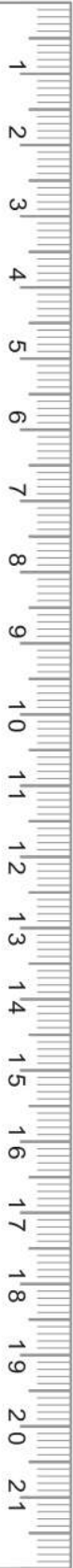

**07-176 - 178**  
**DOYEN**  
 235 mm

Length of blades	Width of blades		
	35 mm	45 mm	60 mm
60 mm	35 mm	45 mm	60 mm <sup>1/2</sup>
90 mm	<b>07-179</b>	<b>07-182</b>	<b>07-186</b>
120 mm	<b>07-180</b>	<b>07-183</b>	<b>07-187</b>
160 mm	<b>07-181</b>	<b>07-184</b>	<b>07-188</b>
		<b>07-185</b>	<b>07-189</b>



1/2

**07-190 - 194**  
 BREISKY  
 WIENER MODELL/  
 VIENNA PATTERN  
**07-190** 100 X 20 mm  
**07-191** 100 X 25 mm  
**07-192** 100 X 30 mm  
**07-193** 100 X 35 mm  
**07-194** 100 X 40 mm  
 300 mm



1/2

**07-195 - 199**  
 BREISKY  
 WIENER MODELL/  
 VIENNA PATTERN  
**07-195** 130 X 20 mm  
**07-196** 130 X 25 mm  
**07-197** 130 X 30 mm  
**07-198** 130 X 35 mm  
**07-199** 130 X 40 mm  
 320 mm



1/2

**07-200**  
 DOYEN  
 lateral speculum  
 80 x 30 mm  
 250 mm



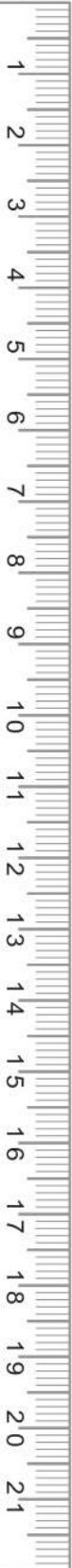

**07-201**  
SIMON  
115 X 22 mm  
275 mm



**07-202**  
AUVARD  
65 X 38 mm - 28 mm  
1,530 kg  
with fixed weight  
230 mm



**07-203 - 204**  
AUVARD  
**12-203** 75 X 42 mm  
(40 mm)  
**07-204** 105 X 43 mm  
(40 mm)  
with detachable wight  
230 mm

**Uterine Dilators**  
**Uterus-dilatatoren**  
**Dilatadores Uterinos**



07-205	1	mm	07-227	23	mm
07-206	2	mm	07-228	24	mm
07-207	3	mm	07-229	25	mm
07-208	4	mm	07-230	26	mm
07-209	5	mm	07-231	1	1/2mm
07-210	6	mm	07-232	2	1/2mm
07-211	7	mm	07-233	3	1/2mm
07-212	8	mm	07-234	4	1/2mm
07-213	9	mm	07-235	5	1/2mm
07-214	10	mm	07-236	6	1/2mm
07-215	11	mm	07-237	7	1/2mm
07-216	12	mm	07-238	8	1/2mm
07-217	13	mm	07-239	9	1/2mm
07-218	14	mm	07-240	10	1/2mm
07-219	15	mm	07-241	11	1/2mm
07-220	16	mm	07-242	12	1/2mm
07-221	17	mm	07-243	13	1/2mm
07-222	18	mm	07-244	14	1/2mm
07-223	19	mm	07-245	15	1/2mm
07-224	20	mm	07-246	16	1/2mm
07-225	21	mm	07-247	17	1/2mm
07-226	22	mm			

**07-205 - 247**  
 HEGAR  
 with very conical point  
 185 mm



07-248	1+2	mm
07-249	3+4	mm
07-250	5+6	mm
07-251	7+8	mm
07-252	9+10	mm
07-253	11+12	mm
07-254	13+14	mm
07-255	15+16	mm
07-256	17+18	mm

**07-248 - 256**  
 HEGAR  
 205 mm

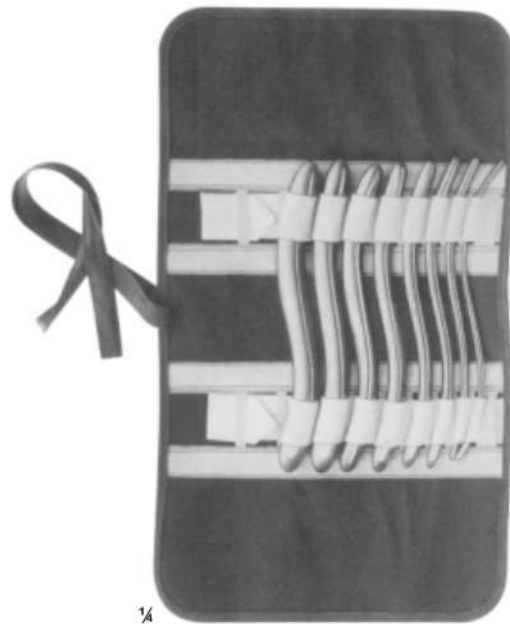

**07-257**  
 HEGAR  
 Uterine dilator set, in canvas  
 roll with 8 dilators.

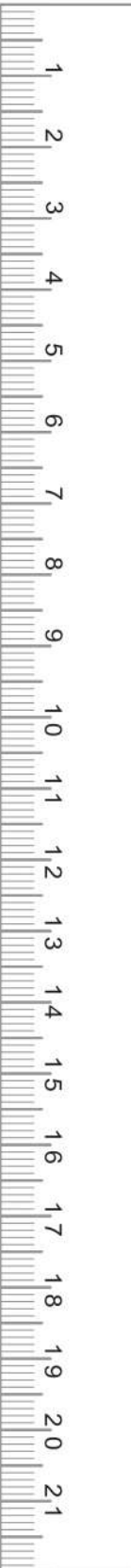





**07-258**  
**HEGAR**  
 Dilator set consisting of:  
 14 Dilators,  
 1 Rack for dilators ( 4 - 12 mm )  
 1 Rack for Dilators ( 13 - 17 mm )  
 1 Metal case only,  
 with hinged lid, stainless 200 X 100 X 35 mm

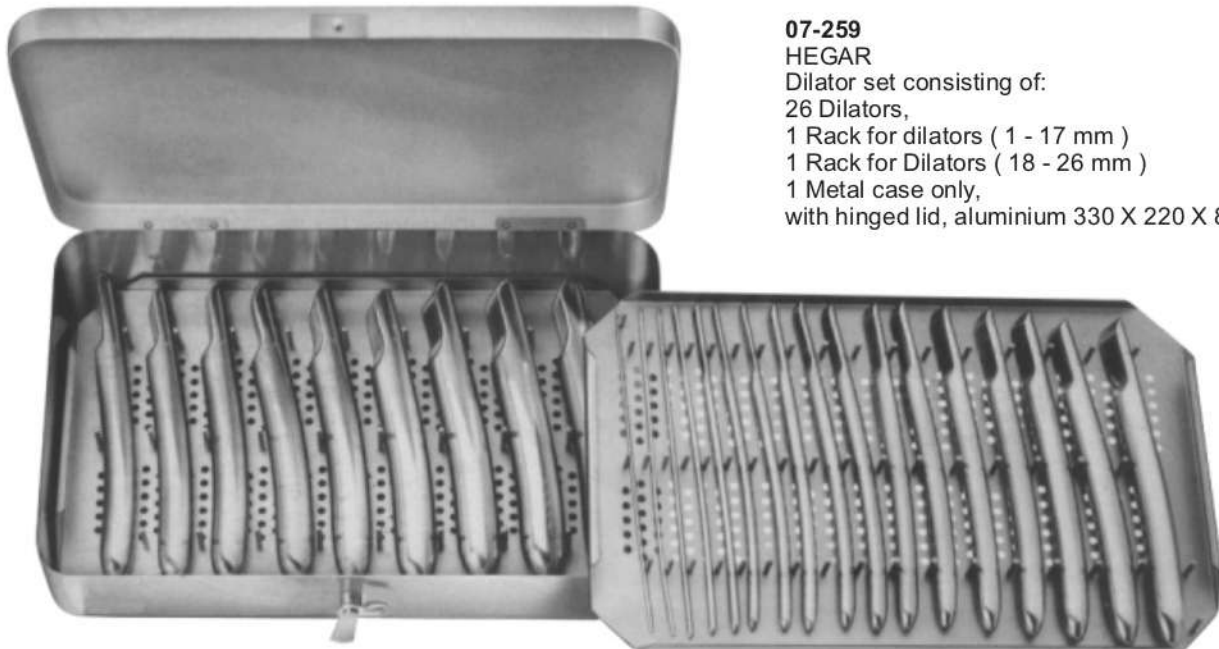

**07-259**  
**HEGAR**  
 Dilator set consisting of:  
 26 Dilators,  
 1 Rack for dilators ( 1 - 17 mm )  
 1 Rack for Dilators ( 18 - 26 mm )  
 1 Metal case only,  
 with hinged lid, aluminium 330 X 220 X 80 mm

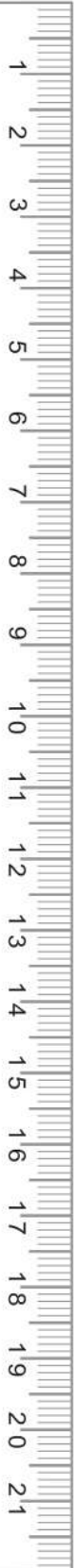



Endospecula For Cervix  
Für Endospecula Cervix  
Endospecula En Cuello Del Útero

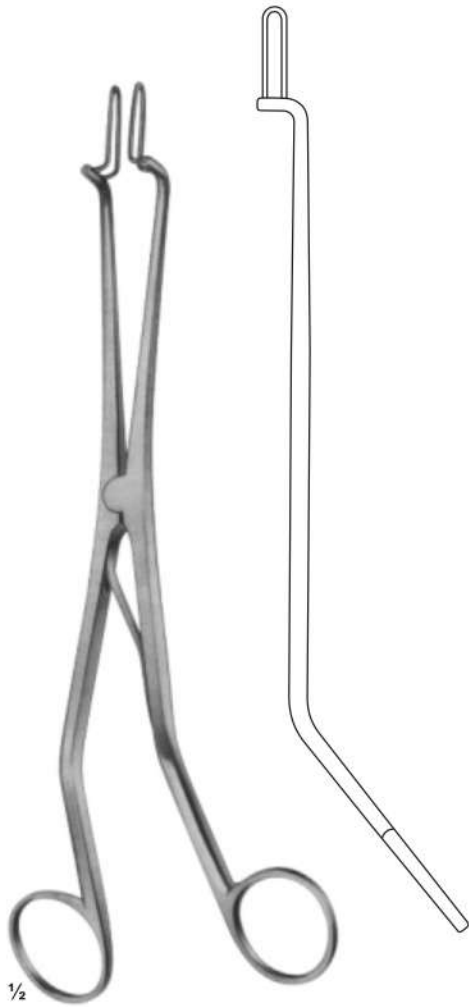

**07-260**  
KOGAN  
Endospecula for cervix  
and urethra, without ratchet  
240 mm



**07-261**  
KOGAN  
Endospecula for cervix  
and urethra, with  
scale-ratchet and fixing screws  
240 mm



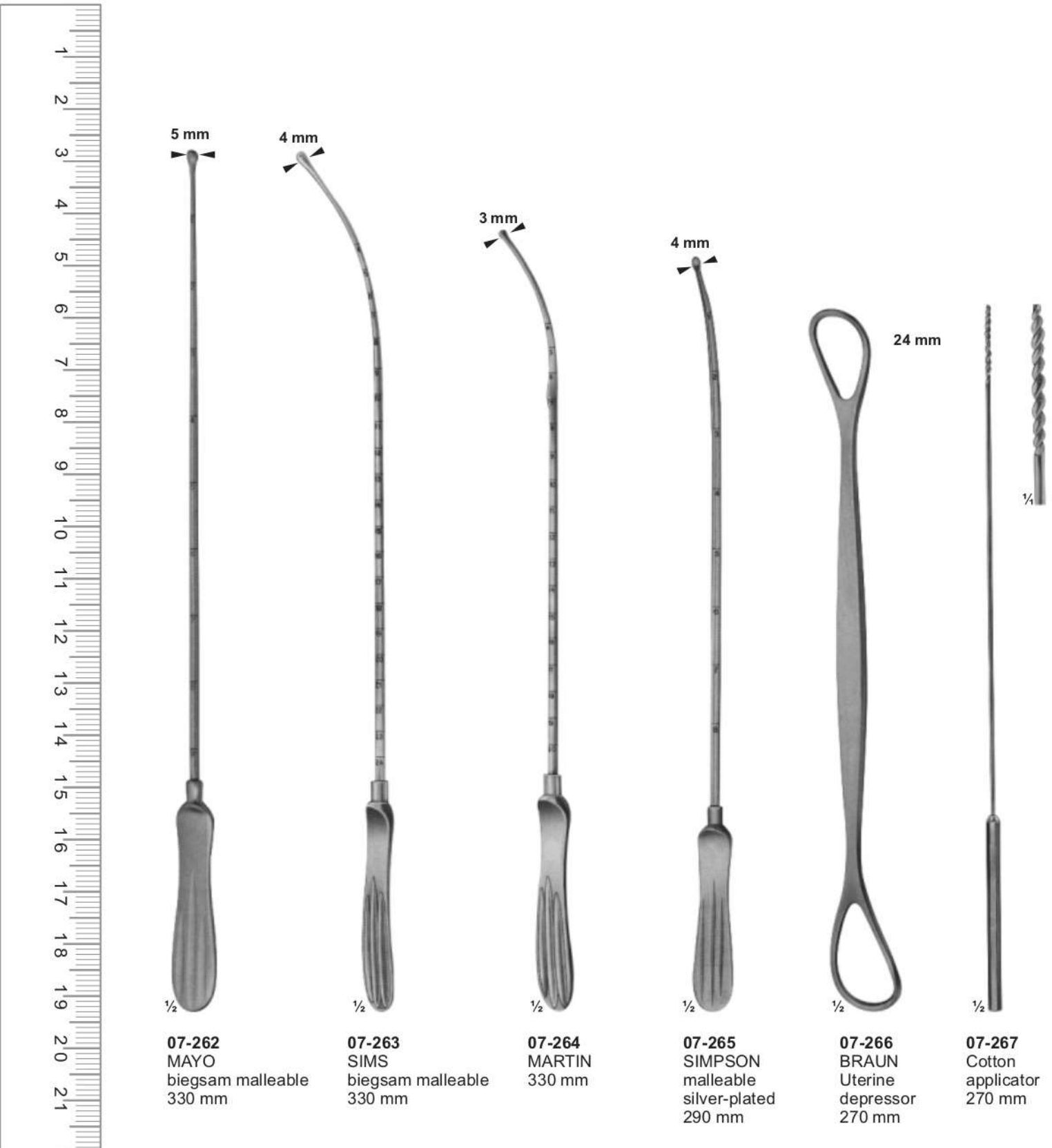

**Uterine Dressing Forceps**  
**Uterine Kornzangen**  
 Uterinos Pinza Dressing



**MATU BROTHERS  
 SURGICAL**

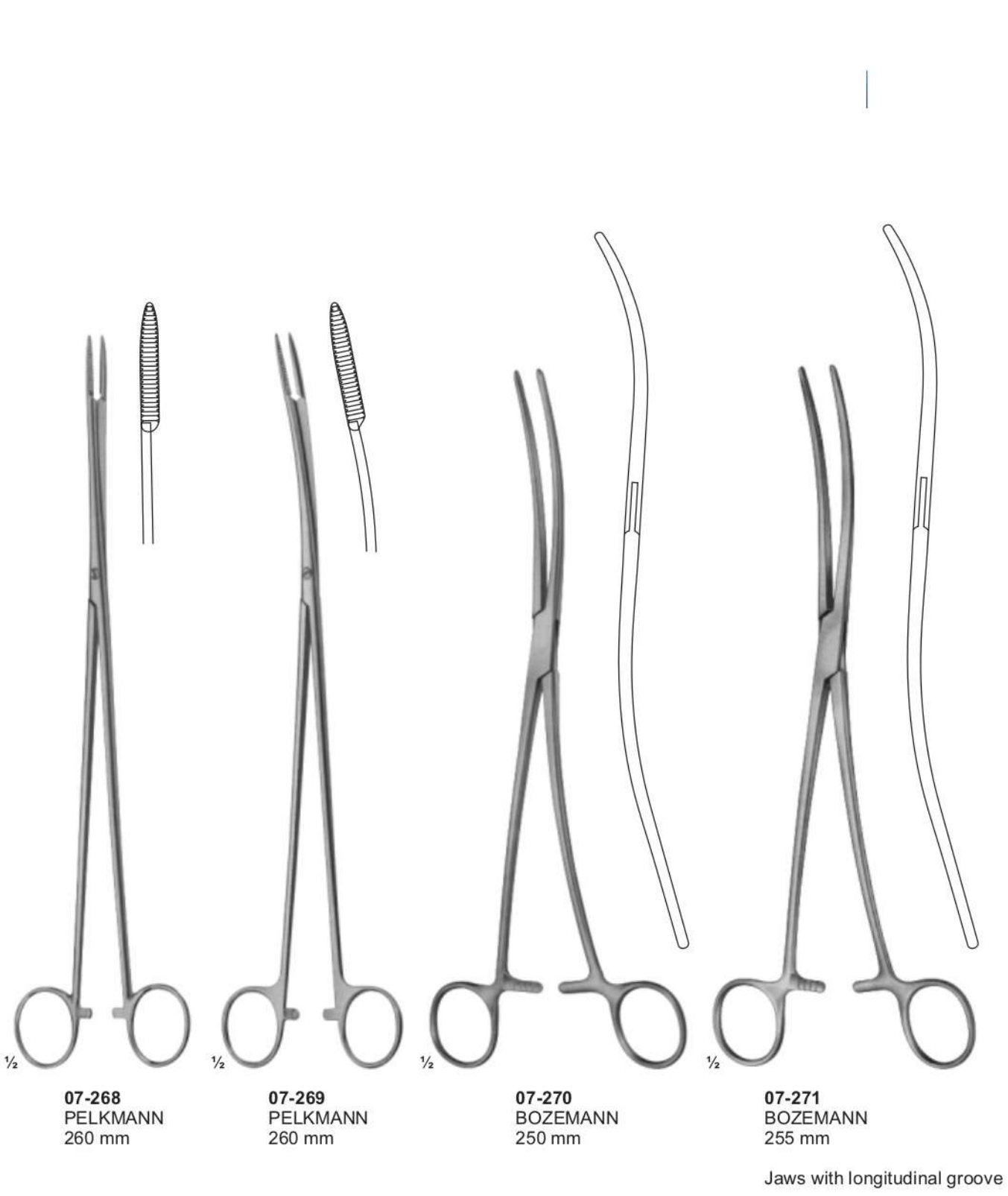

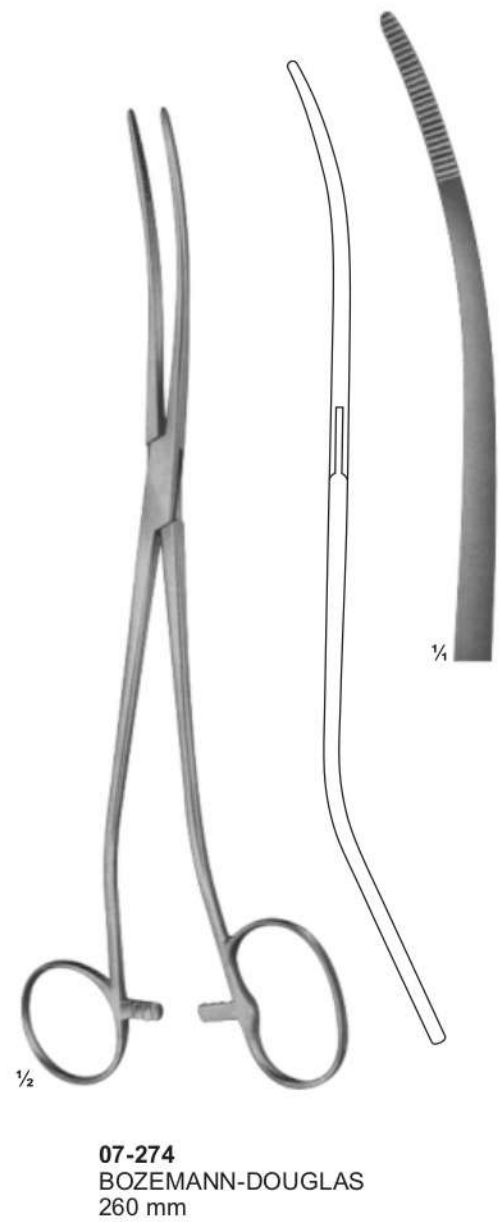
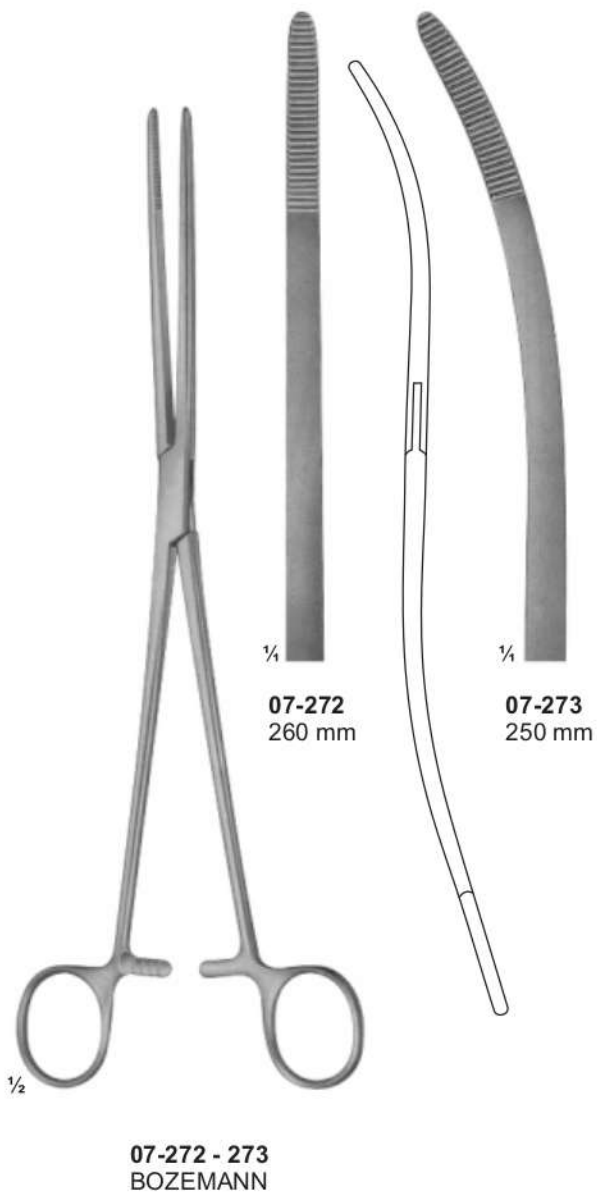
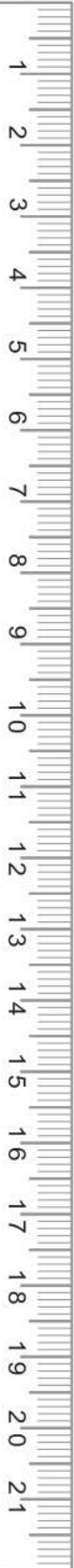



**07-275**  
BRAUN  
slender type  
250 mm



**07-276**  
SCHRODER  
250 mm



**07-277**  
POZZI  
heavy type  
255 mm

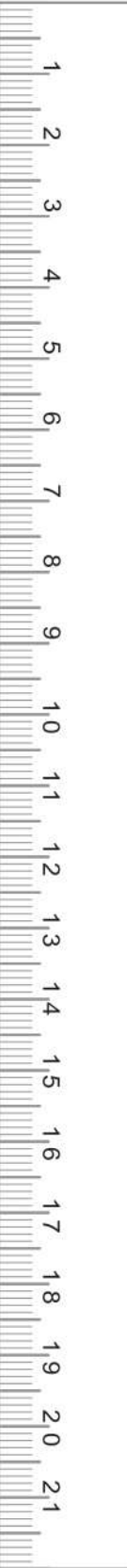



$\frac{1}{2}$   
**07-278**  
265 mm

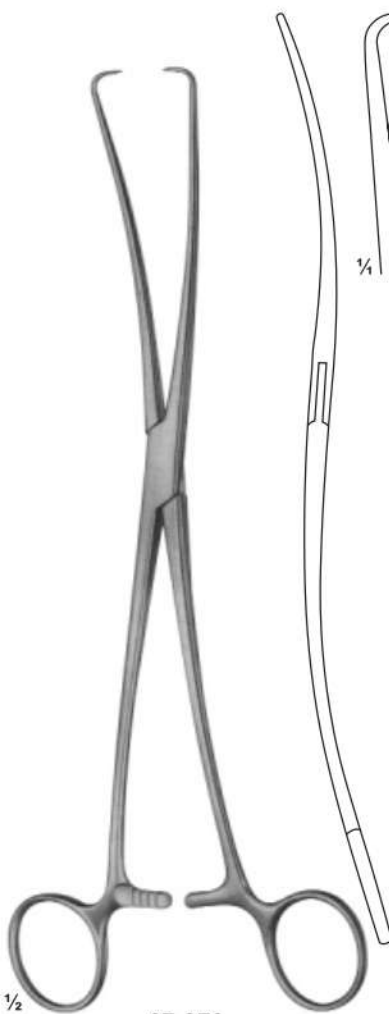

$\frac{1}{2}$   
**07-279**  
DUPLAY  
250 mm

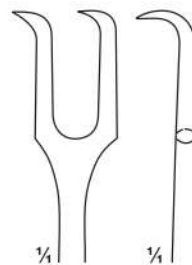
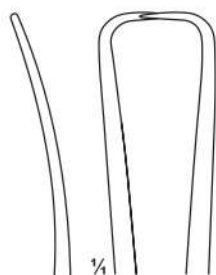

$\frac{1}{2}$   
**07-280**  
LAHEY  
155 mm

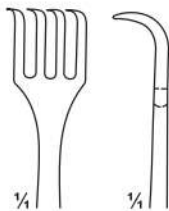

$\frac{1}{2}$   
**07-281 - 283**  
SCHRODER  
250 mm



$\frac{1}{4}$   
**07-281**  
straight



$\frac{1}{4}$   
**07-282**  
curved  
on flat



$\frac{1}{4}$   
**07-283**  
curved  
sideways

**Uterine Tenaculum Forceps**  
 Uterine Tenakulum Zange  
 Pinza Uterina Tenáculo



**MATU BROTHERS  
 SURGICAL**

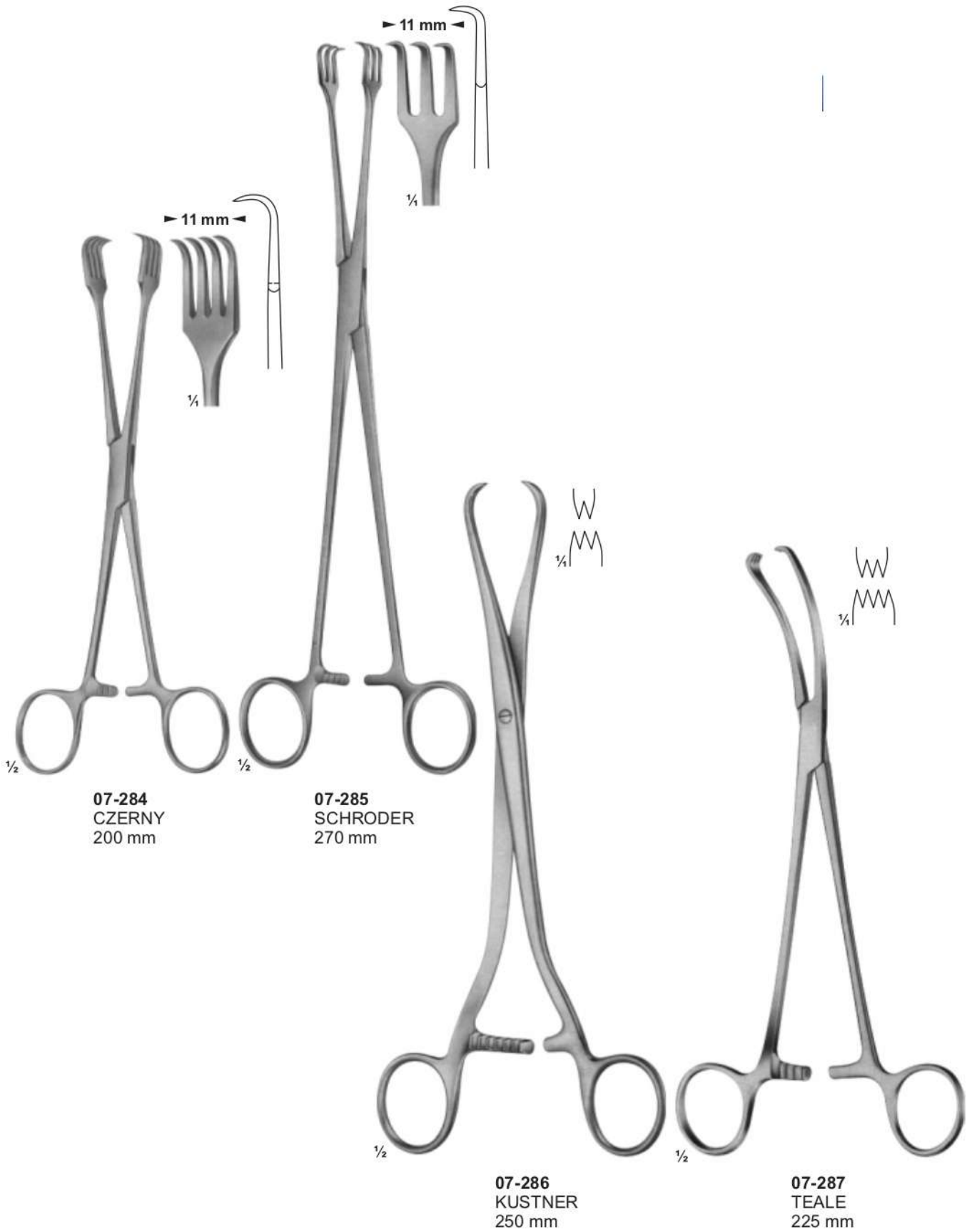

**07-284**  
 CZERNY  
 200 mm

**07-285**  
 SCHRODER  
 270 mm

**07-286**  
 KUSTNER  
 250 mm

**07-287**  
 TEALE  
 225 mm



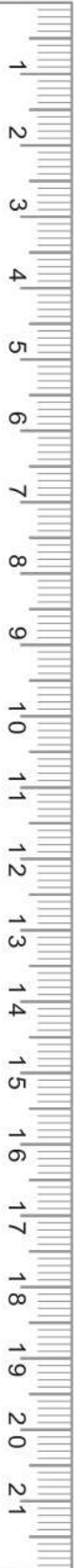

**07-288**  
SOMER  
235 mm



**07-289**  
STRASSMANN  
260 mm

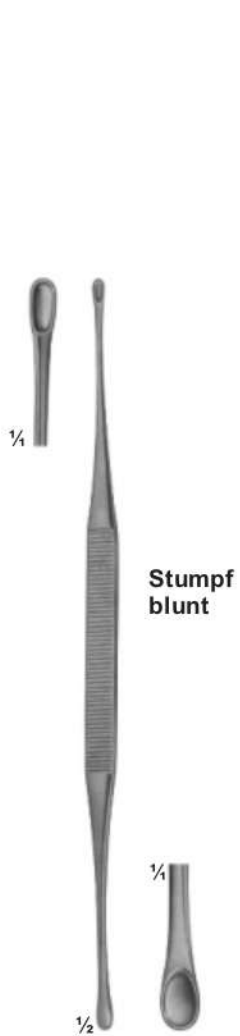

**07-290**  
**ASCH**  
 Uterine  
 Secretion scoop  
 200 mm

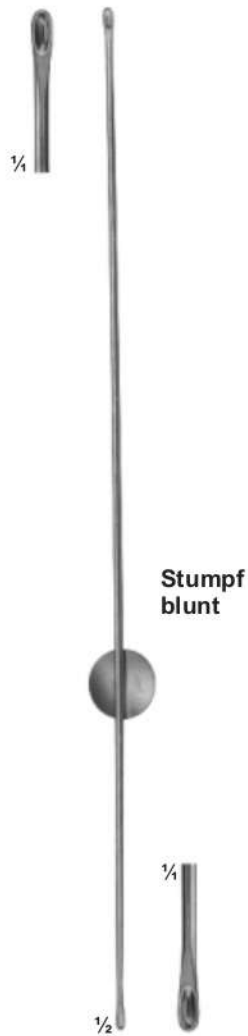

**07-291**  
 Uterine  
 Secretion scoop  
 270 mm



**07-292**  
**NOVAK-SCHOECKAERT**  
 Endometrial biopsy  
 curette  
 240 mm



**07-293**  
**RANDALL**  
 Endometrial biopsy  
 curette  
 240 mm



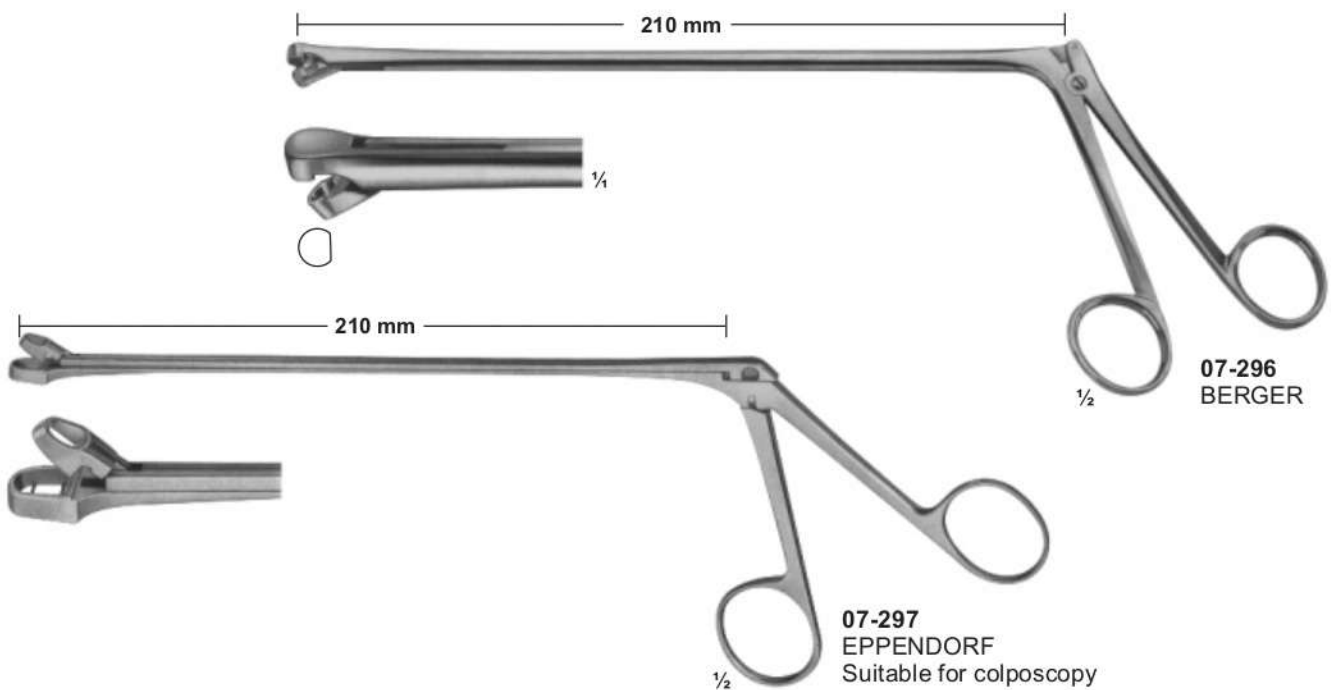
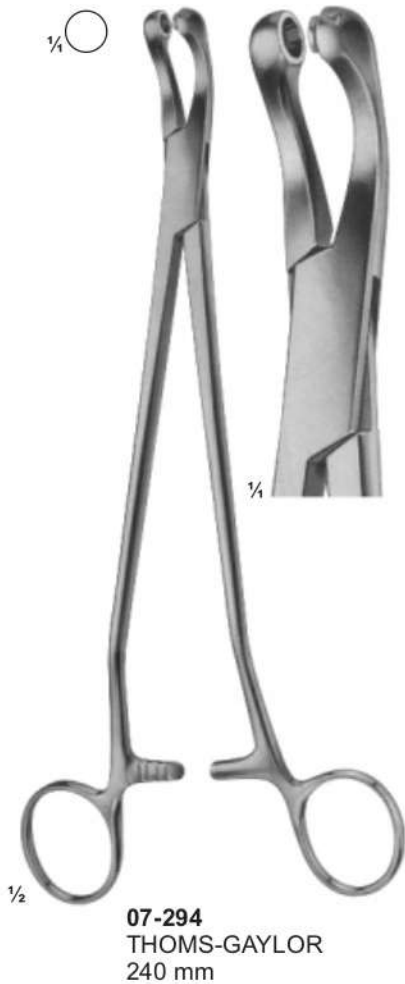

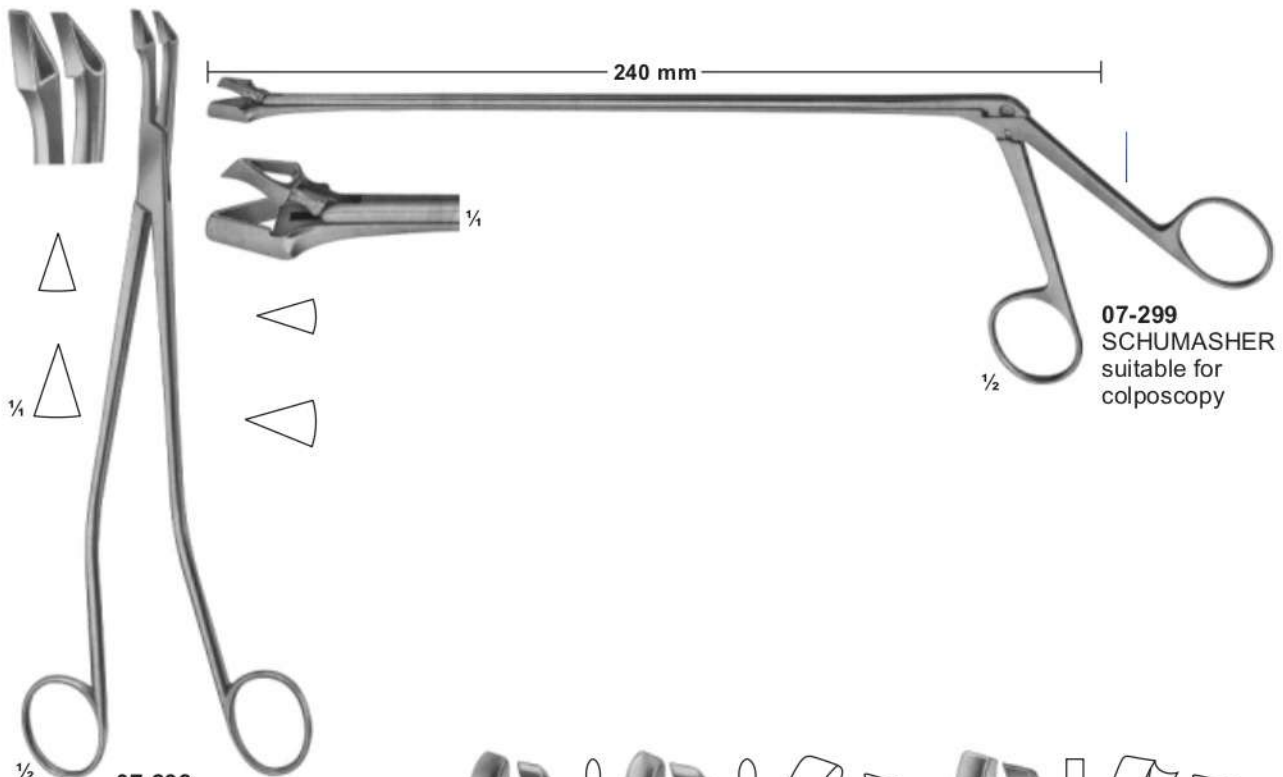

**07-298**  
**SCHUMASHER**  
 240mm

**07-299**  
**SCHUMASHER**  
 suitable for  
 colposcopy

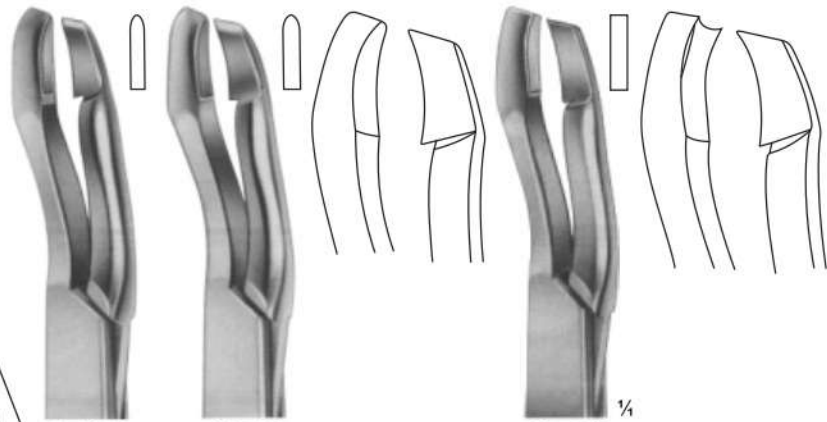

**07-300**  
 2.0 mm

**07-301**  
 2.4 mm

**07-302**  
 2.4 mm

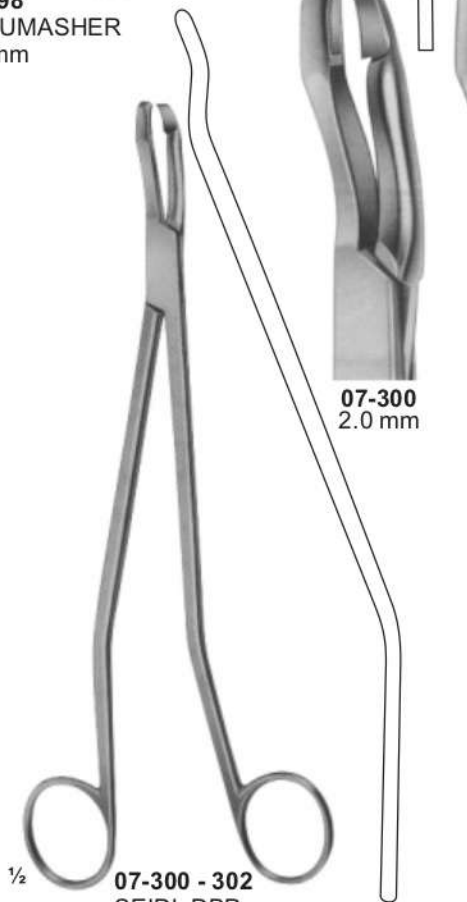

**07-300 - 302**  
**SEIDL DBP**  
 Biopsy forceps, bayonet shaped  
 for portio, vagina and vulva  
 240mm

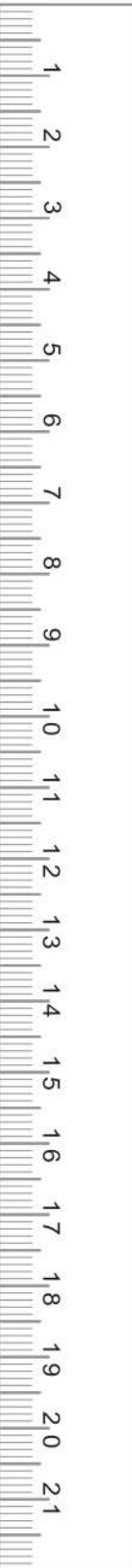
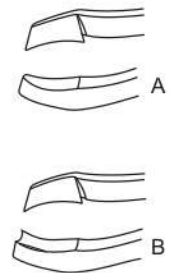

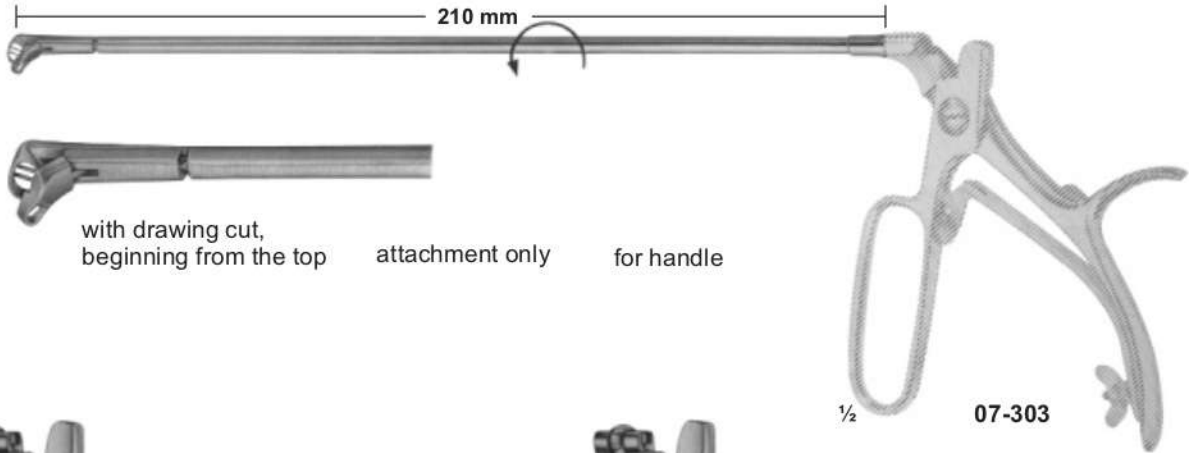
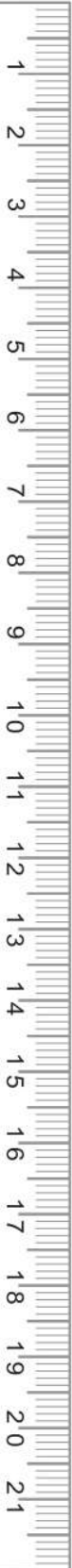

210 mm  
with drawing cut, beginning from the top attachment only for handle

1/2 07-303



1/2 07-304  
140 mm

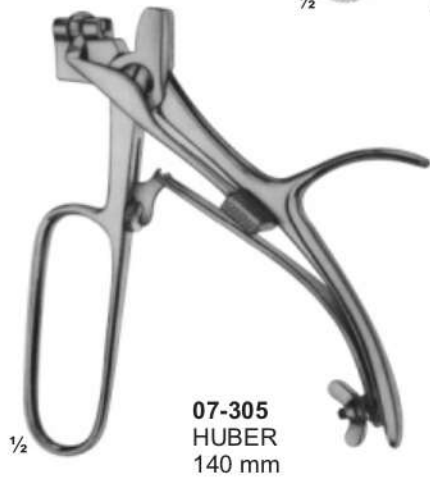

1/2 07-305  
HUBER  
140 mm



07-306 BRUENINGS 200 mm Length  
07-307 BRUENINGS 250 mm Length



⊕ ⊕  
07-308 KRAUSE ( Biopsy tip )



⊕  
07-309 SCHEINMANN ( Biopsy tip )



△  
07-310 SCHEINMANN ( Biopsy tip )  
with drawing cut

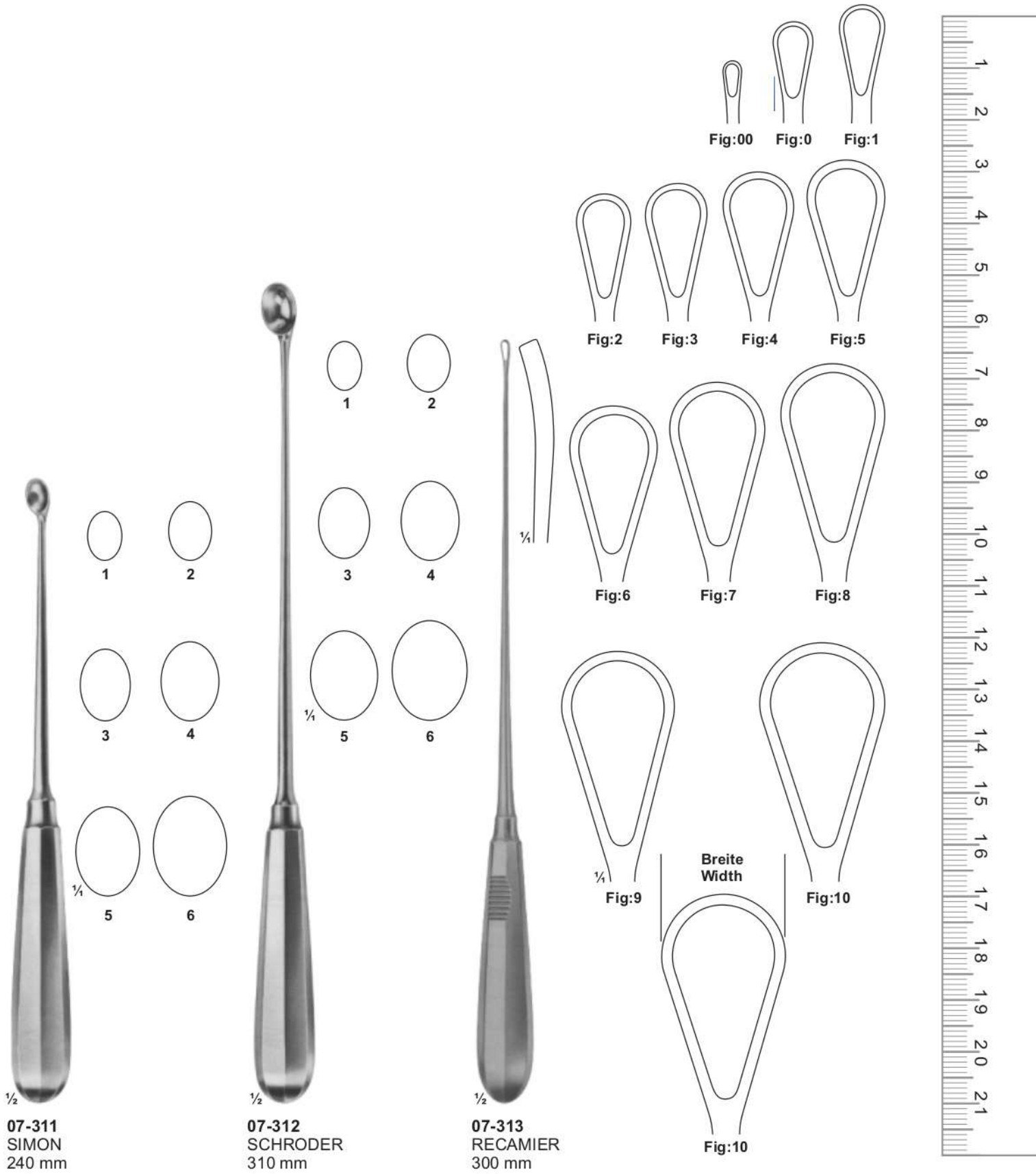

$\frac{1}{2}$   
**07-311**  
 SIMON  
 240 mm

$\frac{1}{2}$   
**07-312**  
 SCHRODER  
 310 mm

$\frac{1}{2}$   
**07-313**  
 RECAMIER  
 300 mm

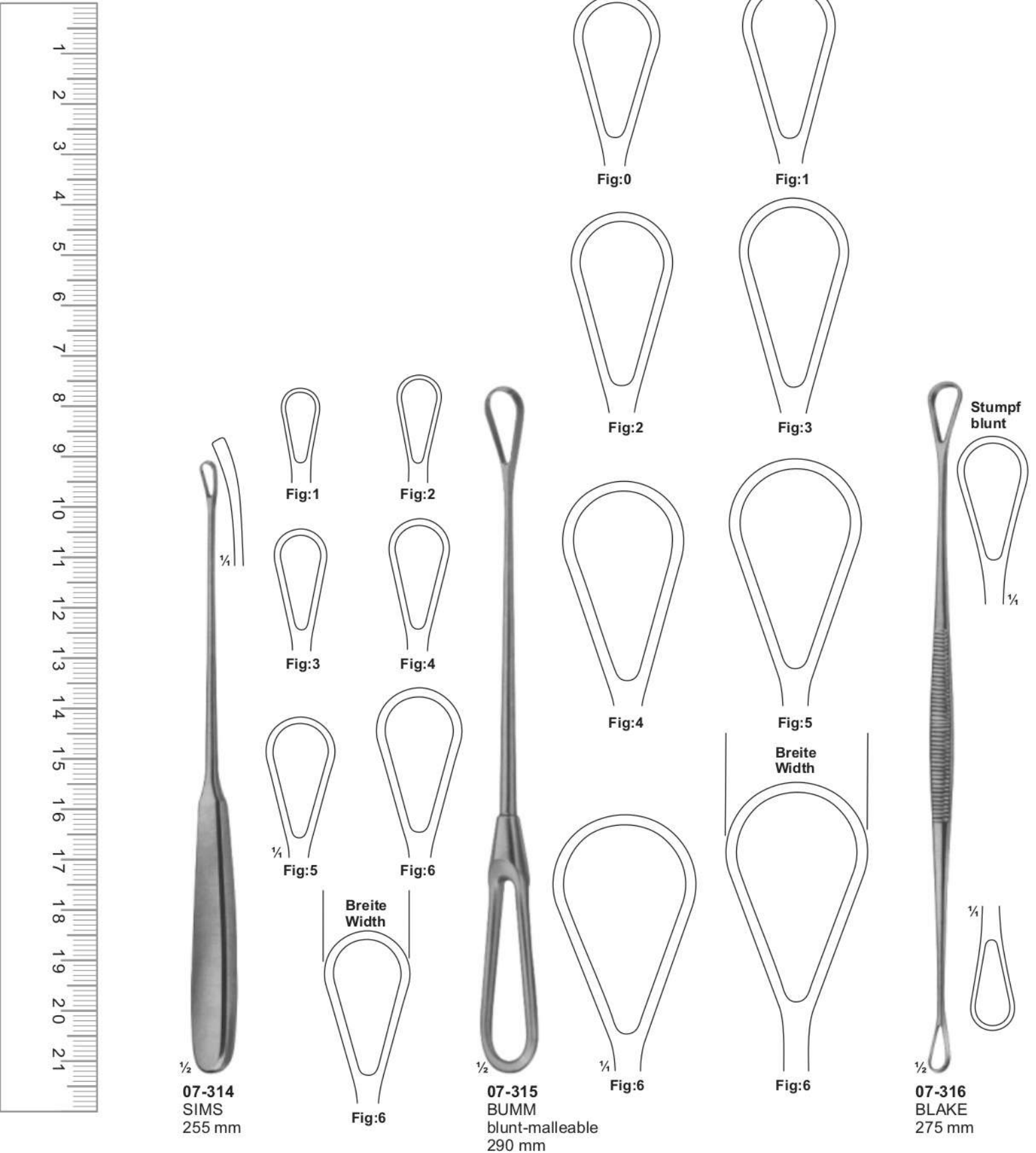

**07-314**  
**SIMS**  
 255 mm

**07-315**  
**BUMM**  
 blunt-malleable  
 290 mm

**07-316**  
**BLAKE**  
 275 mm



**Placenta-and Ovum Curettes**  
**Plazenta-und Ovum Küretten**  
**La Placenta Y Ovum Curetas**



**07-317**  
**COLLIN**  
300 mm



**07-318**  
**RECAMIER**  
blunt-rigid  
360 mm

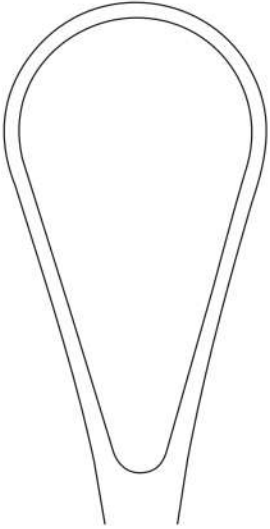

**Fig:1**

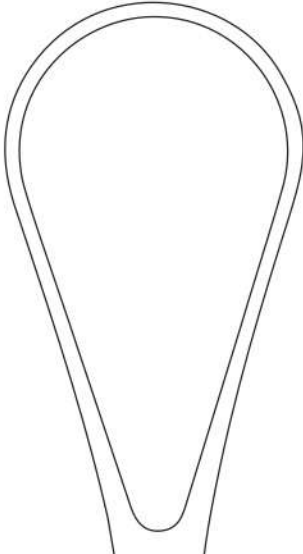

$\frac{1}{4}$   
**Fig:2**



**07-319**  
**BUMM**  
310 mm

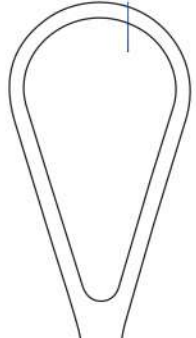

**Fig:1**

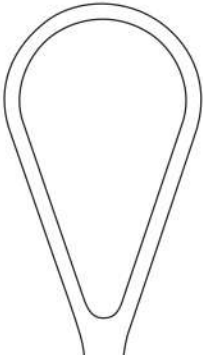

**Fig:2**

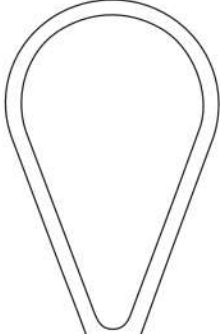

$\frac{1}{4}$   
**Fig:3**

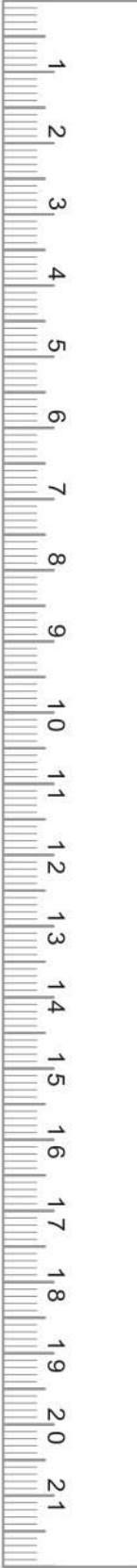



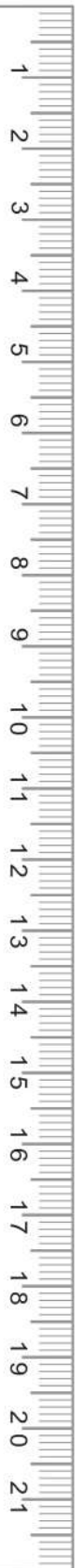

**07-320**  
**THOLE**  
for internal and external measurements, graduated in centimeters

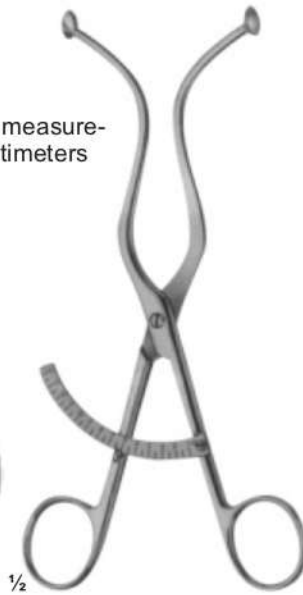

**07-321**  
**DE LEE**  
graduated in centimeters and inches



**07-322**  
**COLLIN**  
graduated in centimeters



**07-323**  
**MARTIN**  
graduated in centimeters



for internal measurements between symphysis and promontory

**07-324**  
**COLLIN**  
graduated in centimeters

The additional straight arm can be replaced. The pelvimeter with straight arm is used for localisation of the portio vaginalis uteri and of vaginal metastasis.



**07-325**  
**BREISKY**  
graduated in centimeters

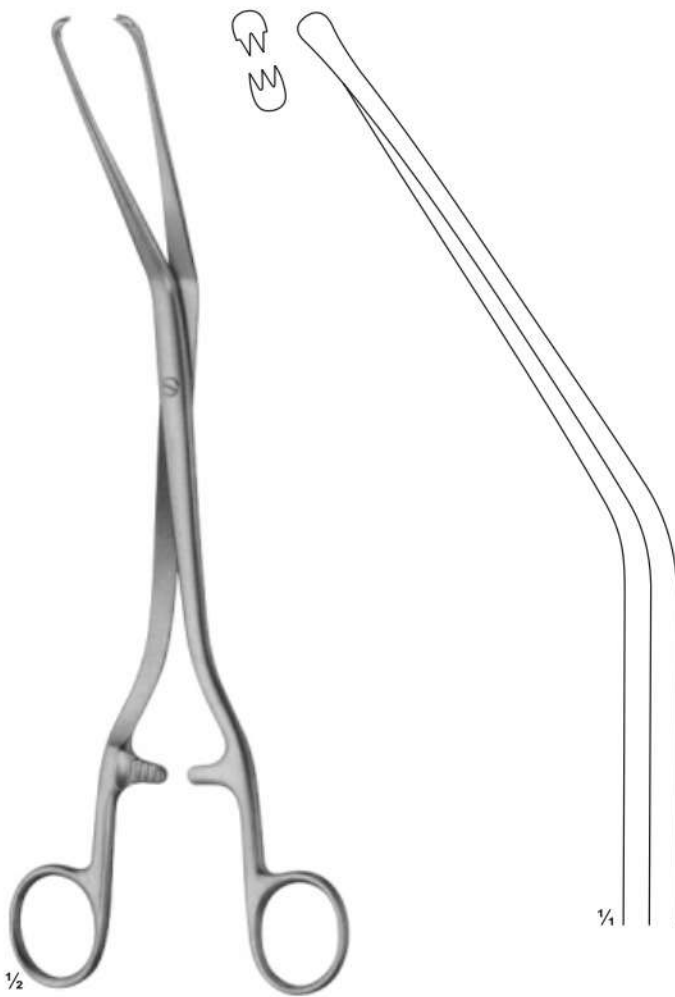

**07-326**  
HERFF  
puncturing forceps  
225 mm



**07-327**  
IOWA  
puncturing forceps  
260 mm

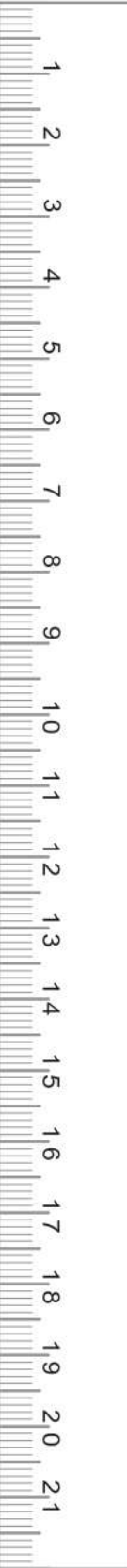

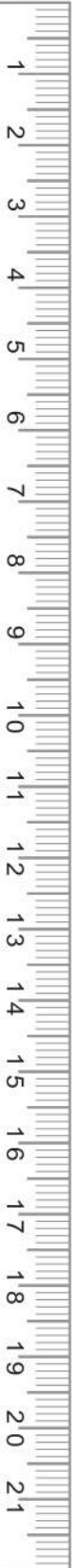

1/3

**07-328**  
SIMPSON-BRAUN  
305mm



1/3

**07-329**  
355 mm



1/3

**07-330**  
400 mm



1/3

**07-331**  
SIMPSON-BRAUN  
305mm



1/3

**07-332**  
SIMPSON  
235mm



1/3

**07-333**  
WRIGLEY  
250 mm



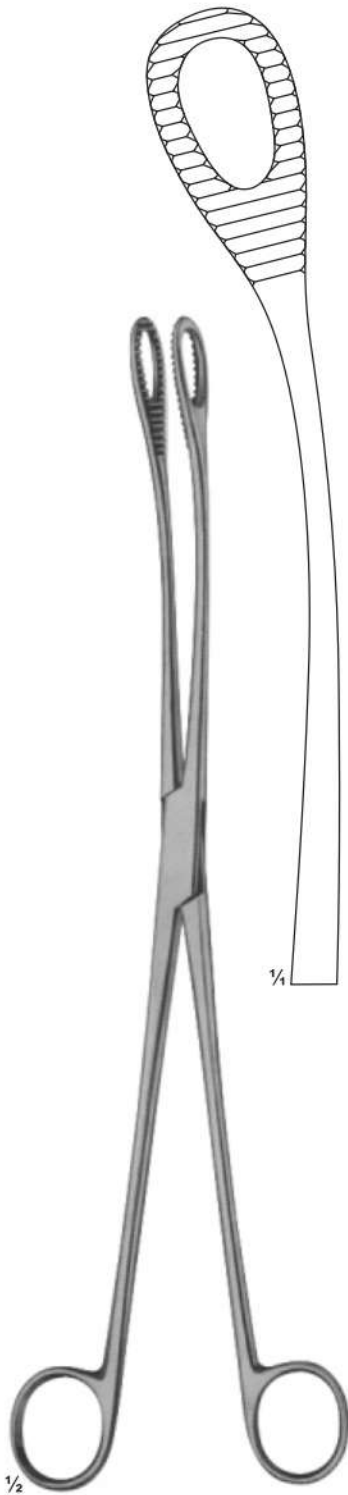
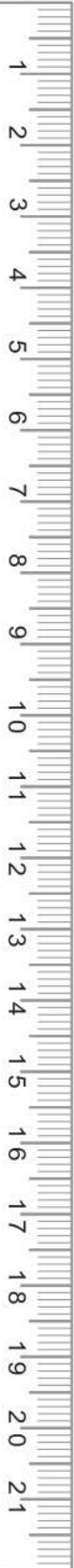

**07-341  
KELLY  
320mm**



**07-342  
SMELLIE  
Perforator  
270mm**



**07-343  
BRAUN  
Cranioclast  
420mm**

# Tound-and Tracheal Hooks and Dilators

Kleinen Kunstwerke zuzusehen und Tracheal-Haken und Dilatatoren

Tound y traqueal Hooks y los dilatadores



**07-344**  
BOSE  
165 mm



**07-345**  
BOSE  
165 mm



**07-346 - 348**  
180 mm



**07-347**  
blunt



**07-348**  
stumpf/blunt



**07-349**  
FINSEN  
50 mm



**07-350**  
FINSEN  
70 mm



**07-351**  
TROUSSEAU  
120 mm



**07-352**  
LABORDE  
125 mm



**07-353**  
LABORDE  
strong pattern  
135 mm



**07-354**  
Cleaning Brush  
for tracheal tubes  
285 mm



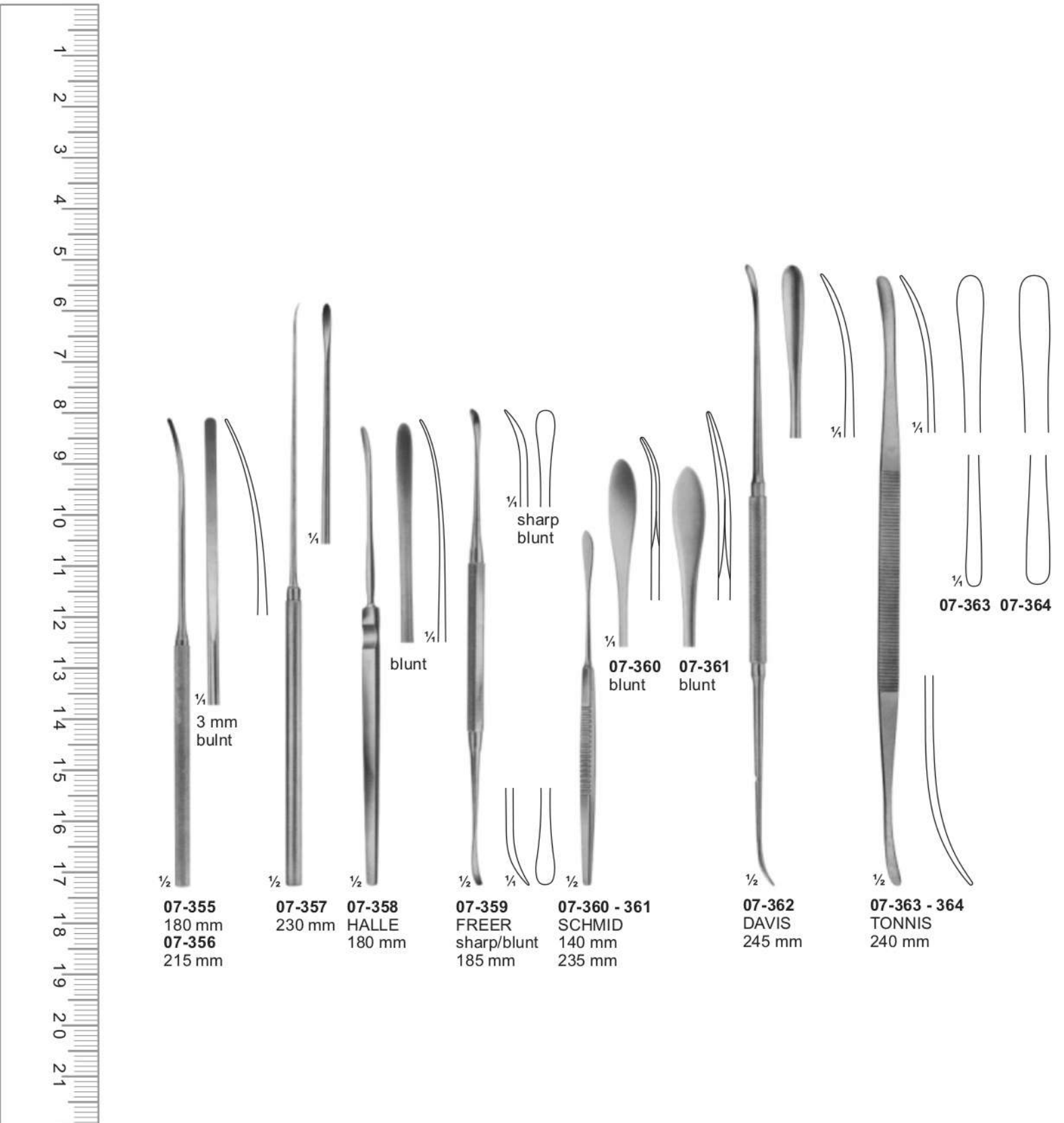

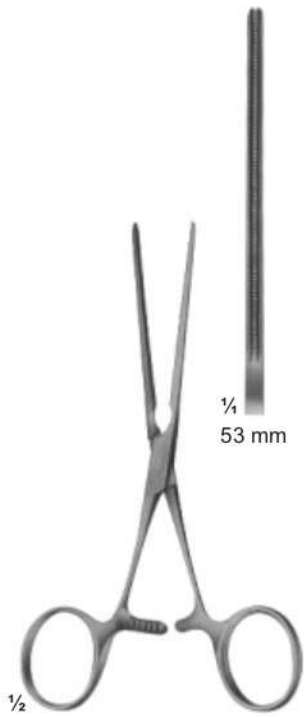

**08-101**  
 DE-BAKEY  
 gerade straight  
 130 mm

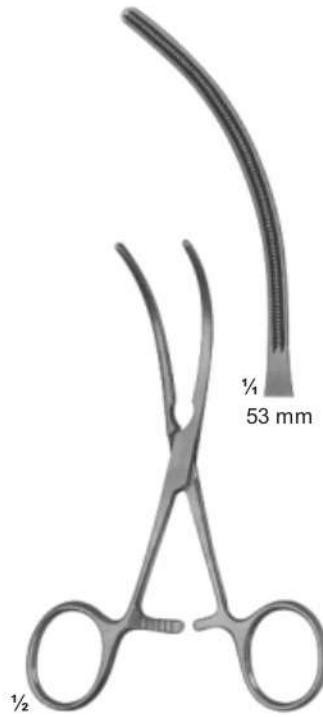

**08-102**  
 DE-BAKEY  
 Maul gebogen  
 curved jaws  
 125 mm

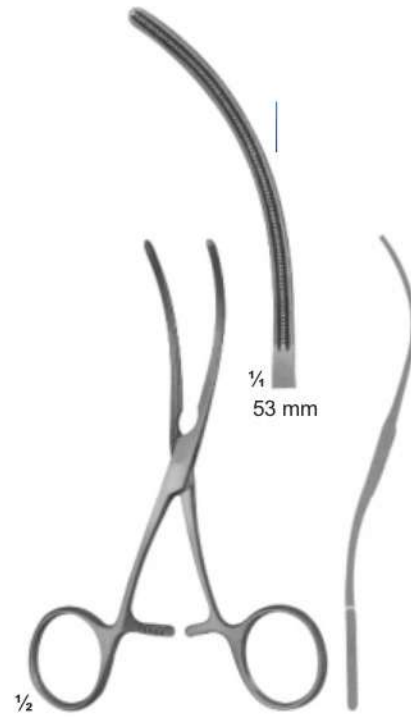

**08-103**  
 DE-BAKEY  
 S-shaped curved  
 125 mm

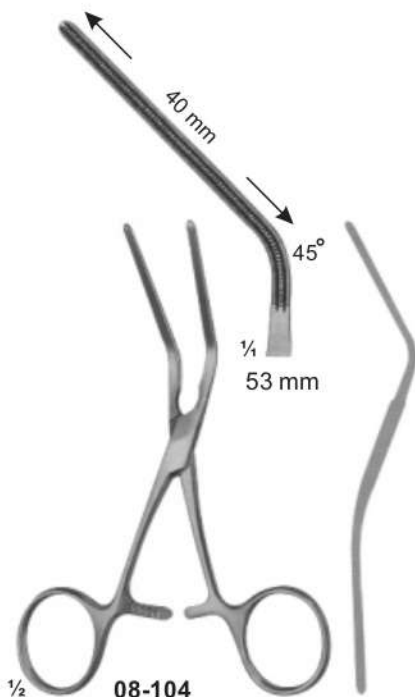

**08-104**  
 DE-BAKEY  
 45 winklig gebogen  
 angled 45°  
 125 mm

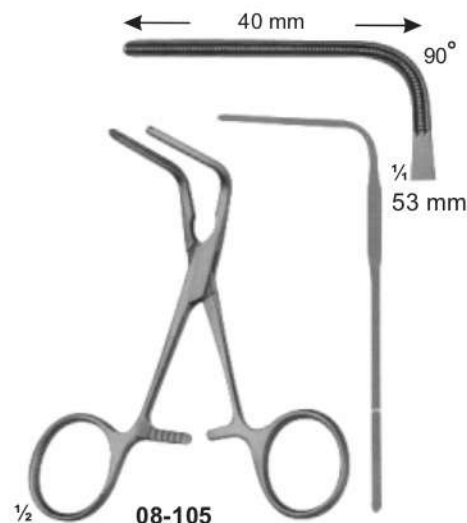

**08-105**  
 DE-BAKEY  
 90 winklig gebogen  
 angled 90°  
 105 mm

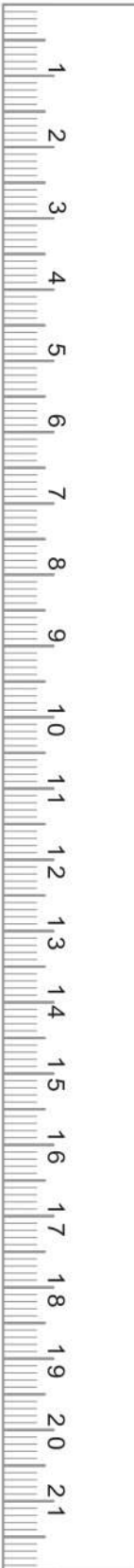



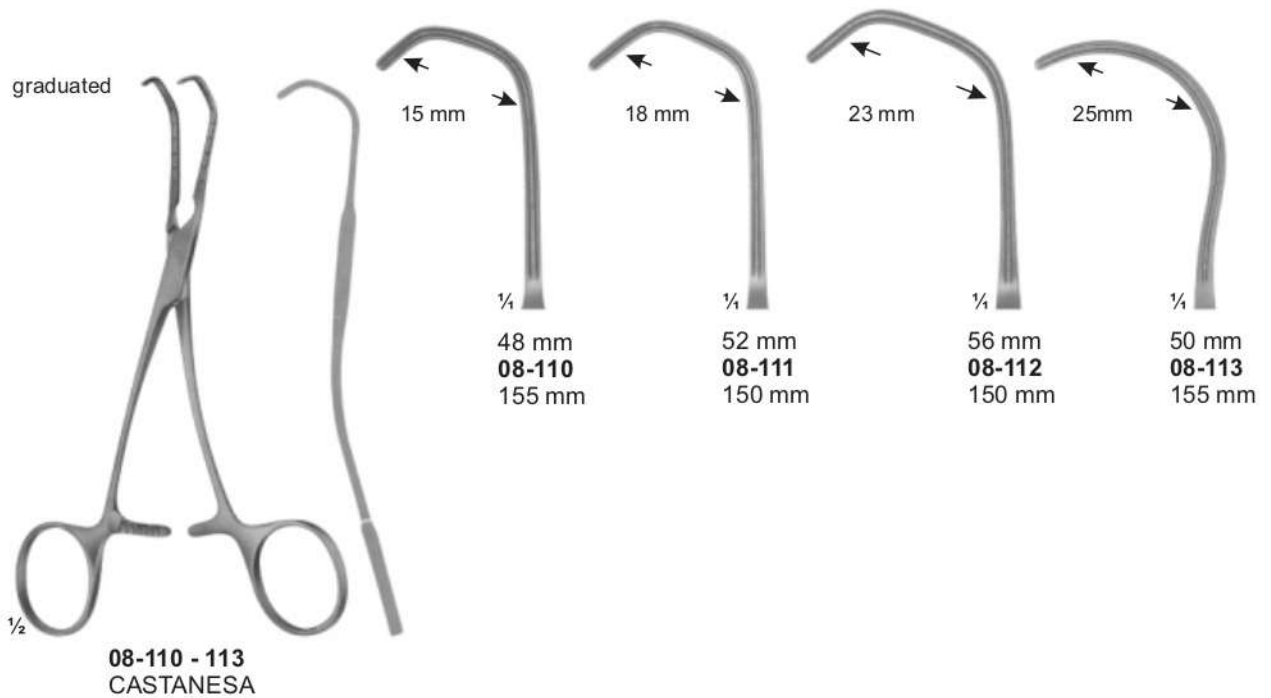
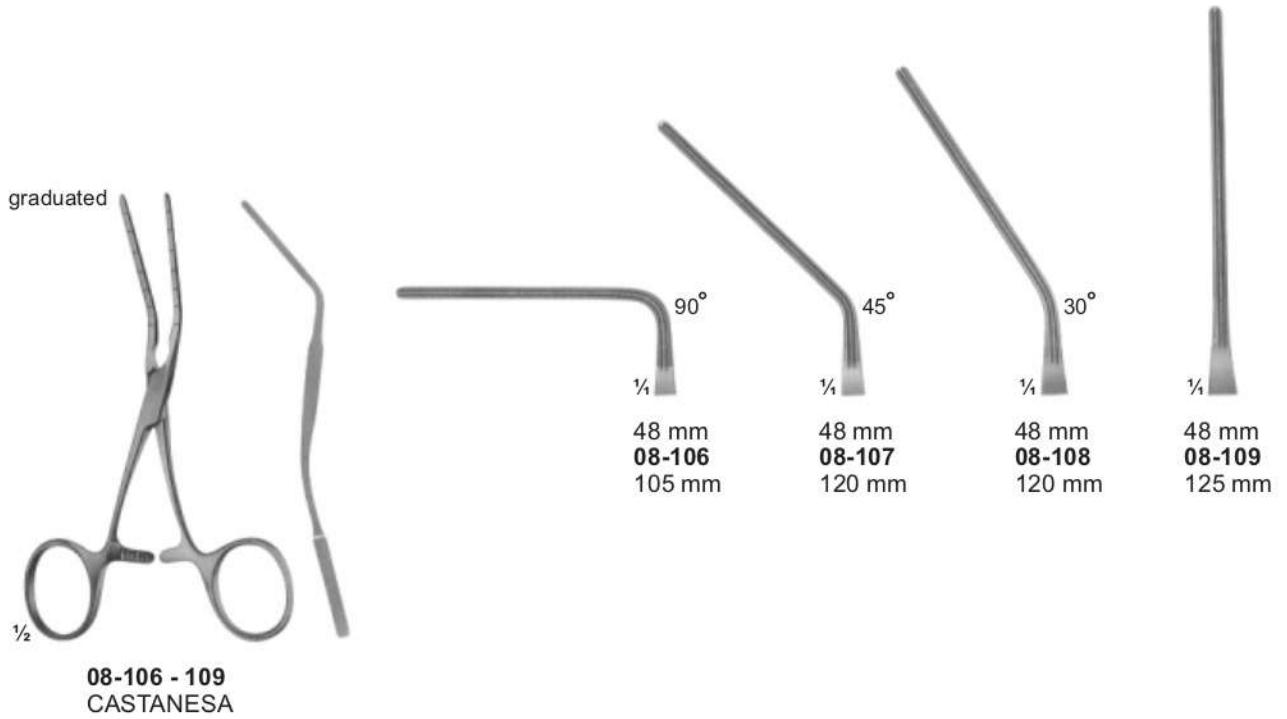
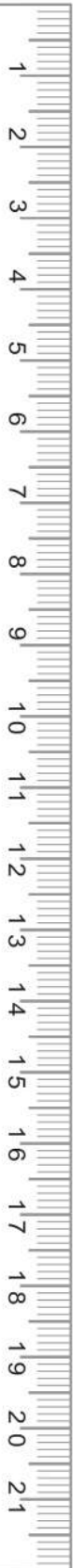

**Anastomosis-and Multi-purpose-clamps-pediatric Types**  
**Anastomose-und Multi-purpose-clamp-pediatric-typen**  
**Anastomosis Y De Propósitos Múltiples De Abrazaderas-pediátricos Tipos**

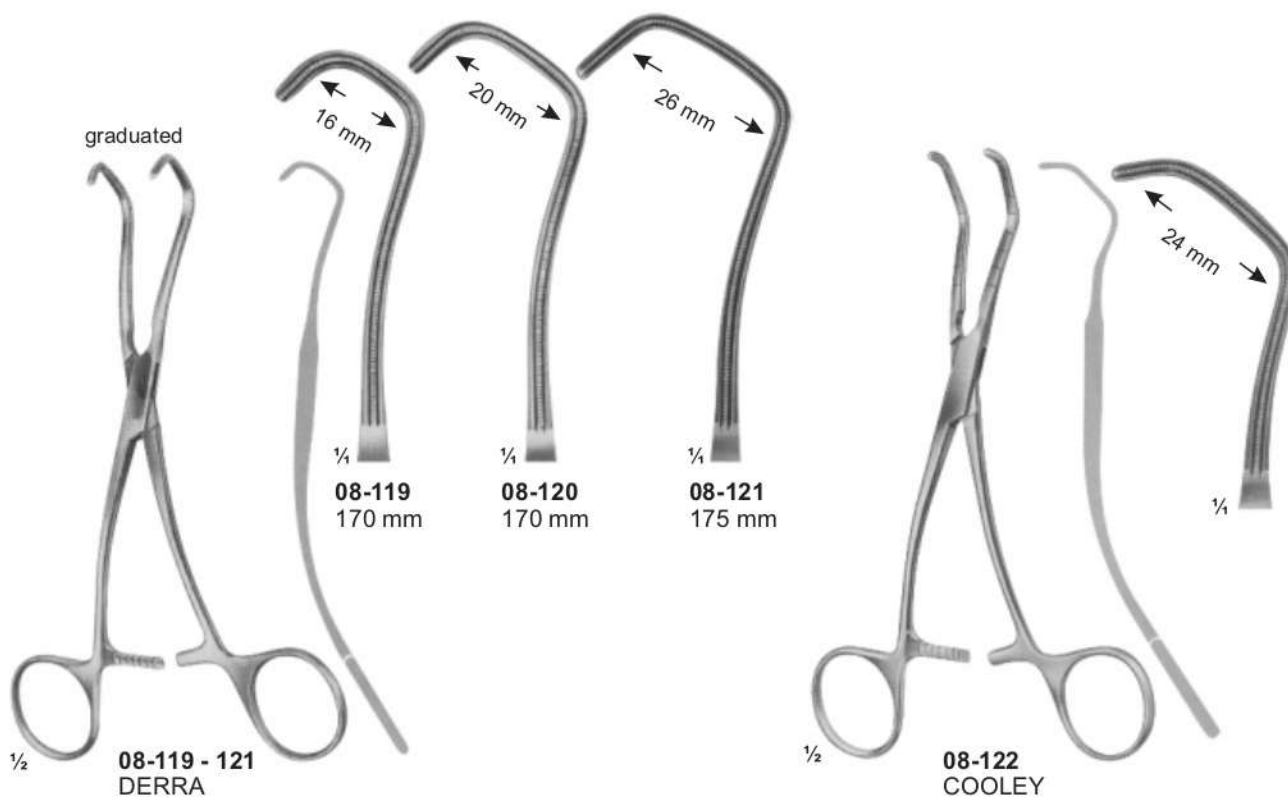
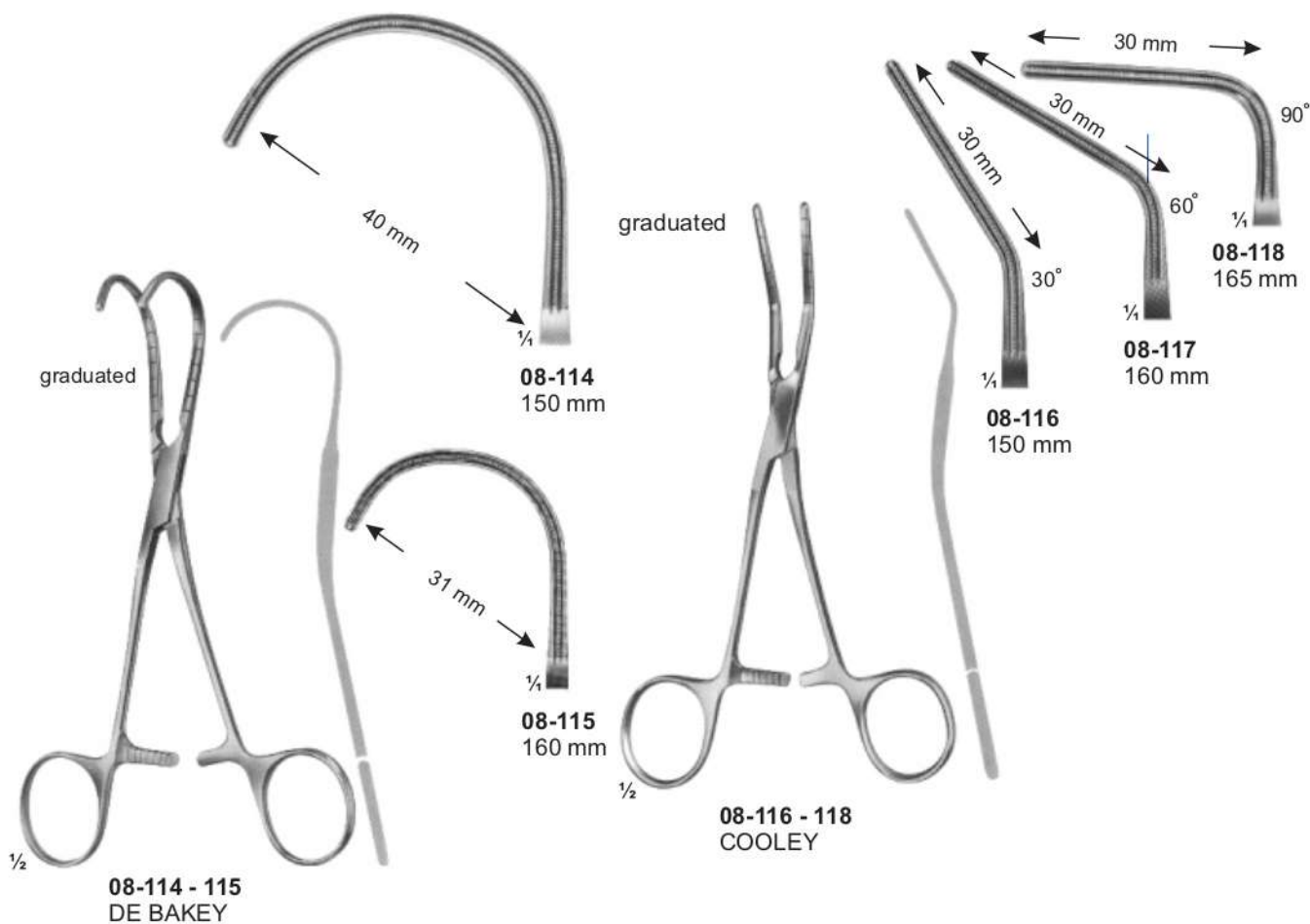

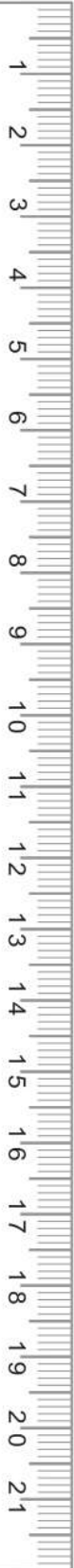

**08-123 - 124**  
**HALSTED**  
 125 mm

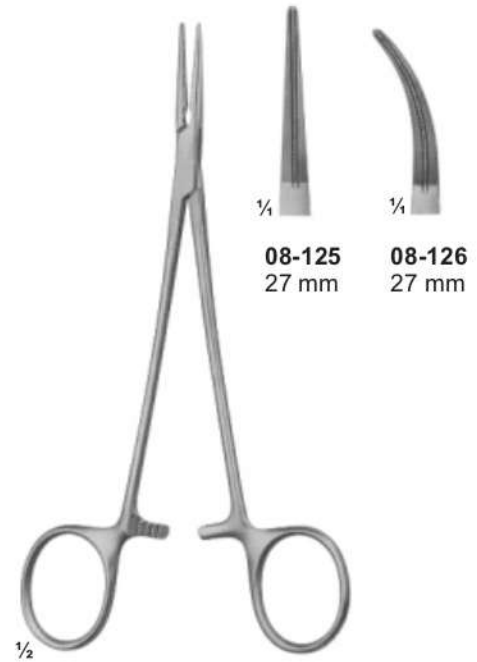

**08-125 - 126**  
**RANKIN**  
 165 mm



**08-127 - 128**  
**DE BAKEY-BAINRIDGE**  
 155 mm

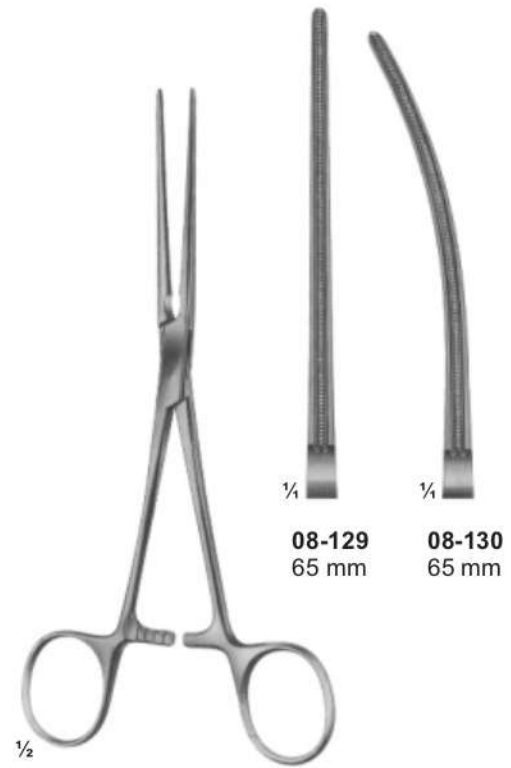

**08-129 - 130**  
**DE BAKEY-BAINRIDGE**  
 180 mm



Non-traumatic Haemostatic Forceps  
Nicht-traumatische Arterienklemme  
No Traumáticas Pinzas Hemostáticas

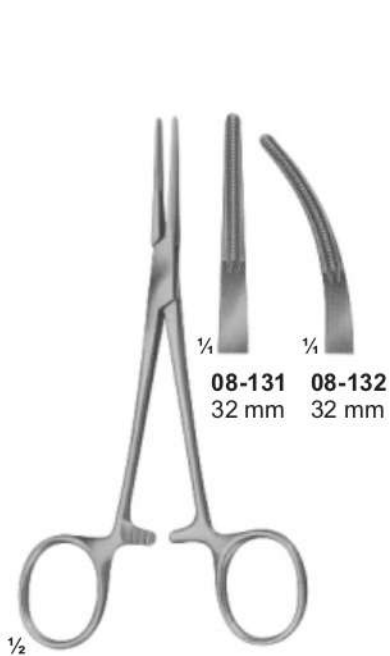

08-131 32 mm  
08-132 32 mm

08-131 - 132  
DE-BAKEY-KELLY  
140 mm

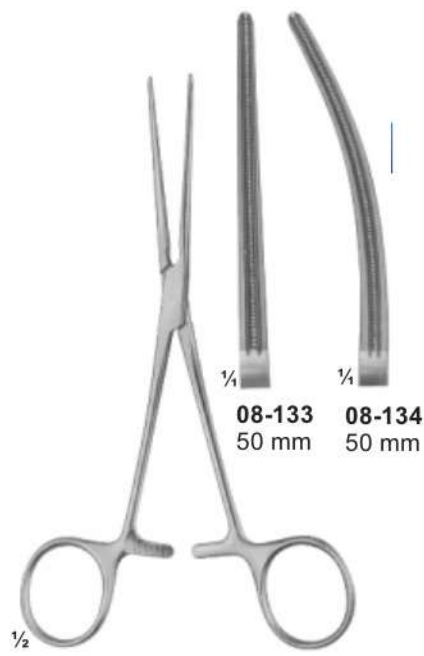

08-133 50 mm  
08-134 50 mm

08-133 - 134  
PEAN  
155 mm

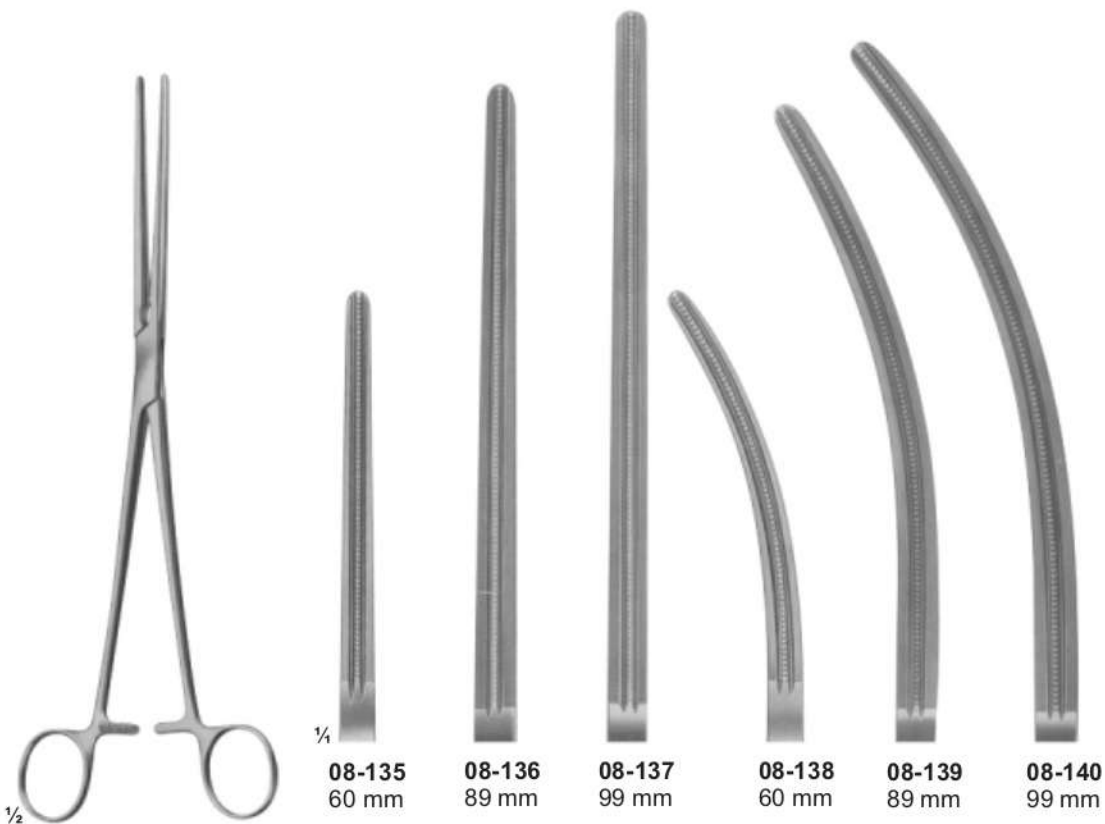

08-135 - 140  
DE-BAKEY-PEAN DE-BAKEY-PEAN  
08-135 200 mm 08-138 200 mm  
08-136 265 mm 08-139 260 mm  
08-137 280 mm 08-140 275 mm



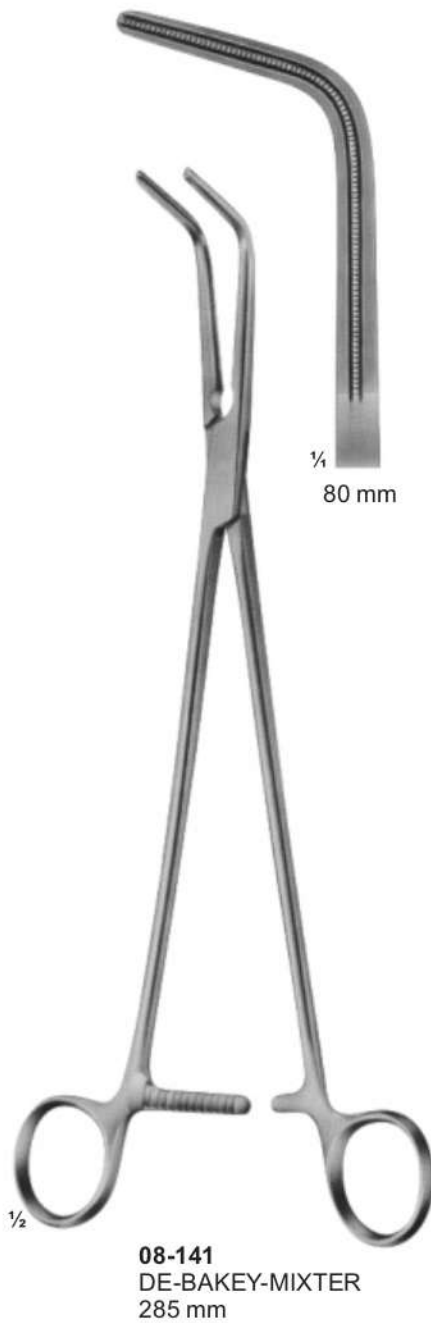

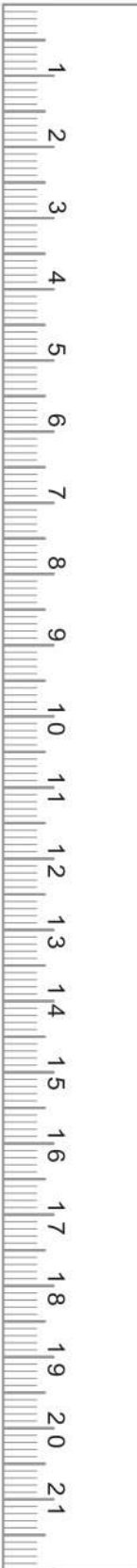
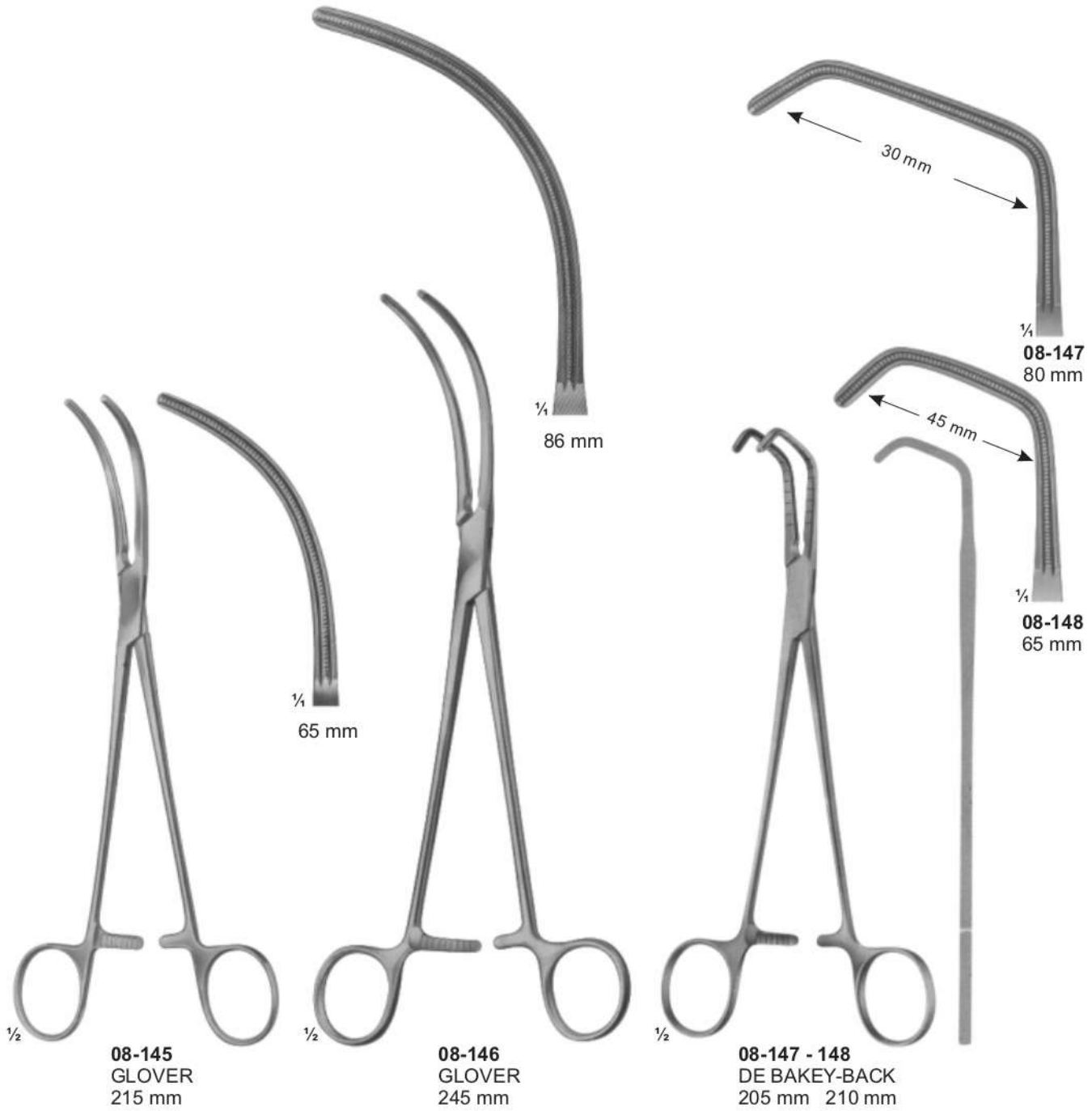

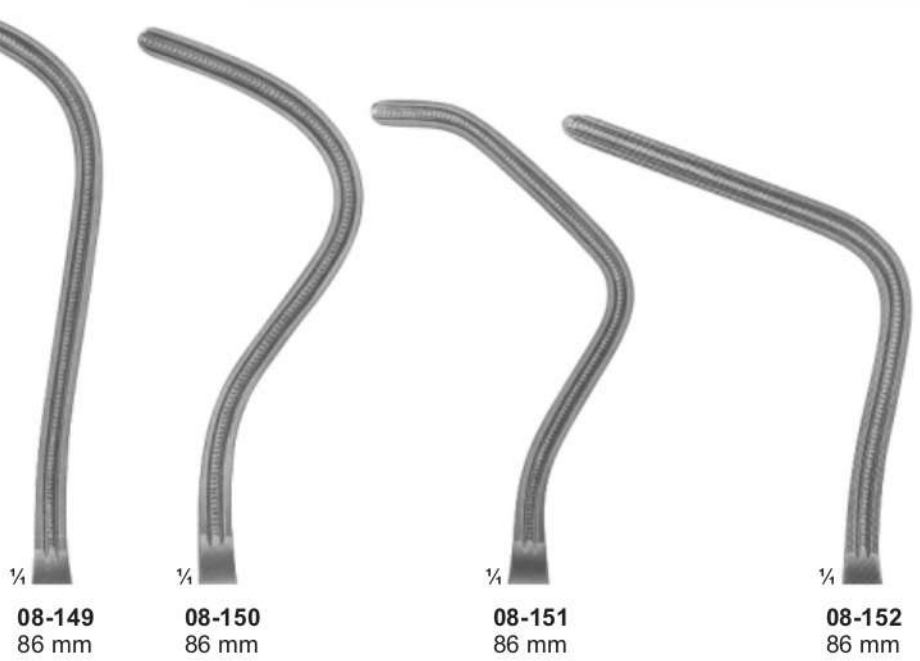
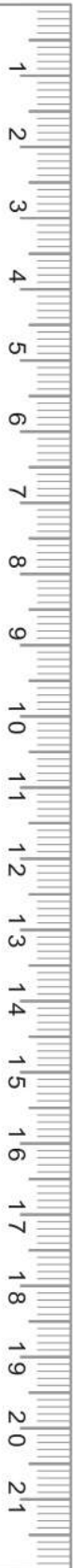

**08-149**  
86 mm

**08-150**  
86 mm

**08-151**  
86 mm

**08-152**  
86 mm

**08-149 - 151**  
DE BAKHEY-HARKEN  
**08-149** - 255 mm  
**08-150** - 245 mm  
**08-151** - 245 mm  
**08-152** - 245 mm

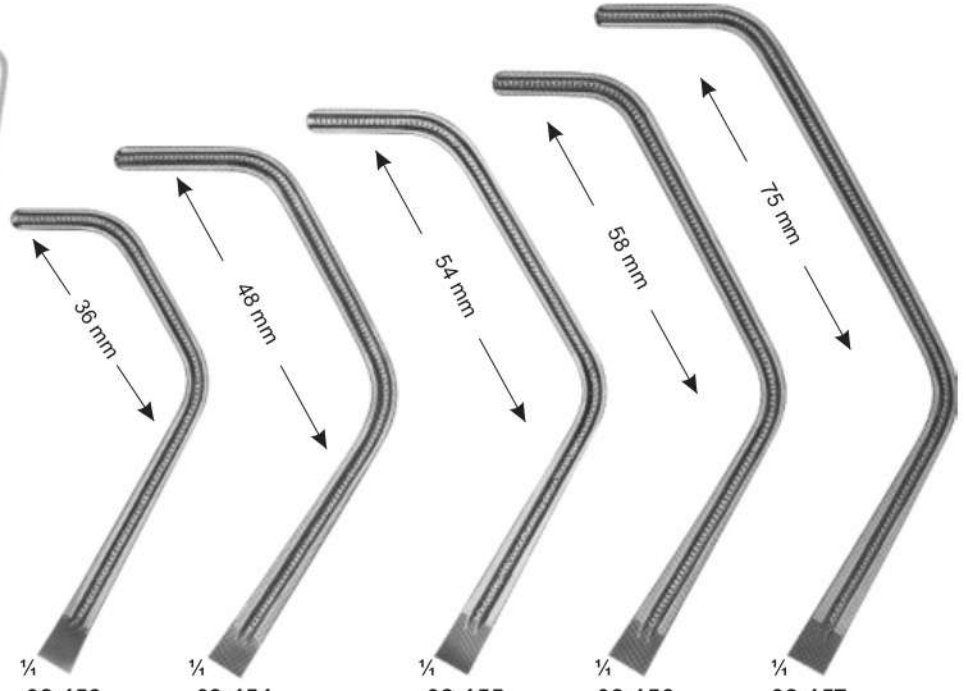

**08-153 - 157**  
DE BAKHEY Total Length: 220 mm  
Length of jaws: 85 mm

**08-153**

**08-154**

**08-155**

**08-156**

**08-157**

256 mm

270 mm

270 mm

280 mm

Length of jaws: 85 mm

95 mm

99 mm

103 mm

119 mm



Vena-cava Clamps  
Vena-cava-klemmen  
Vena Cava Abrazaderas



1/2

**08-158 - 160**  
DE BAKEY-SATINSKY  
235 mm, 240 mm, 245 mm

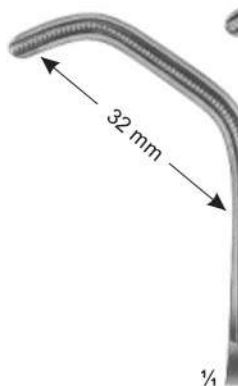

1/4

**08-158**  
68 mm

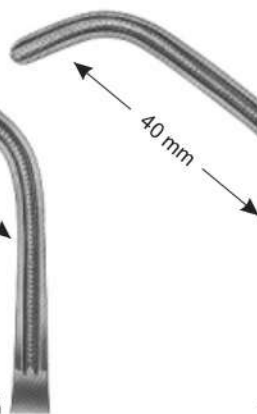

1/4

**08-159**  
76 mm

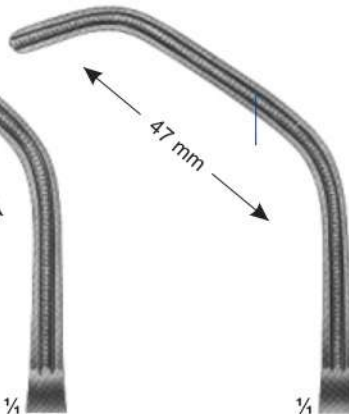

1/4

**08-160**  
84 mm



1/2

**08-161 - 262**  
DE BAKEY  
170 mm, 165 mm

1/4

**08-161**  
50 mm

1/4

**08-162**  
50 mm



1/2

**08-163**  
DE BAKEY  
165 mm

1/4

50 mm





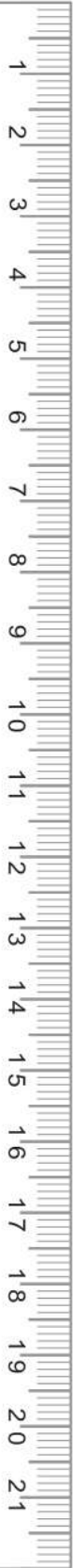

**08-164-166**  
DE BAKEY  
205 mm, 225 mm, 240 mm

**08-164** 41 mm  
**08-165** 65 mm  
**08-166** 80 mm



**08-167 - 169**  
DE BAKEY  
200 mm, 225 mm, 240 mm

**08-167** 41 mm  
**08-168** 65 mm  
**08-169** 80 mm

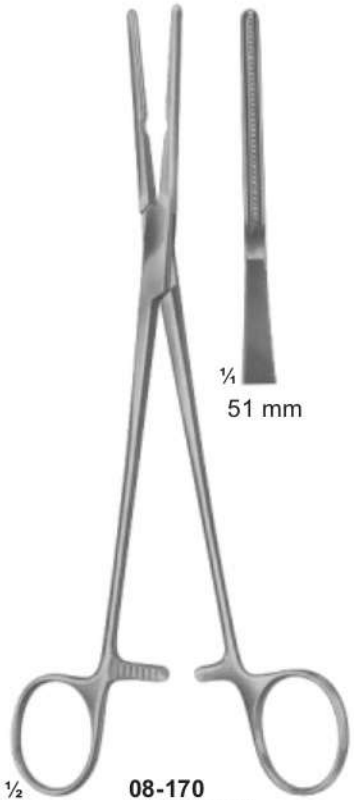

**08-170**  
DE BAKEY  
210 mm

$\frac{1}{4}$   
51 mm



**08-171**  
DE BAKEY  
210 mm

15°  
 $\frac{1}{4}$   
51 mm

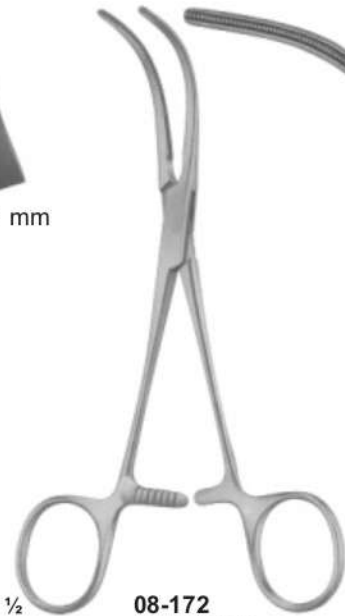

**08-172**  
DE BAKEY  
160 mm

$\frac{1}{4}$   
56 mm

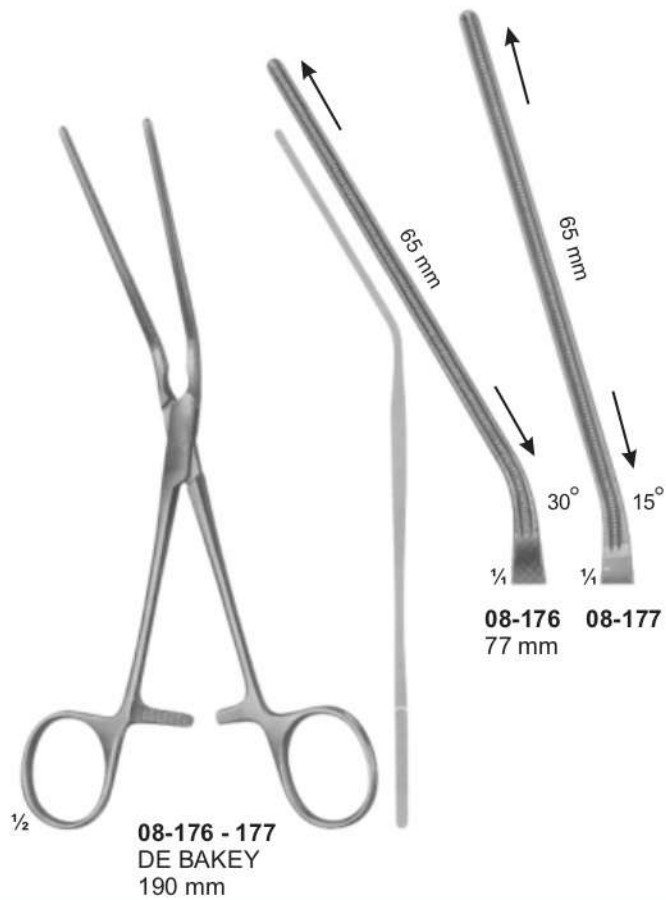
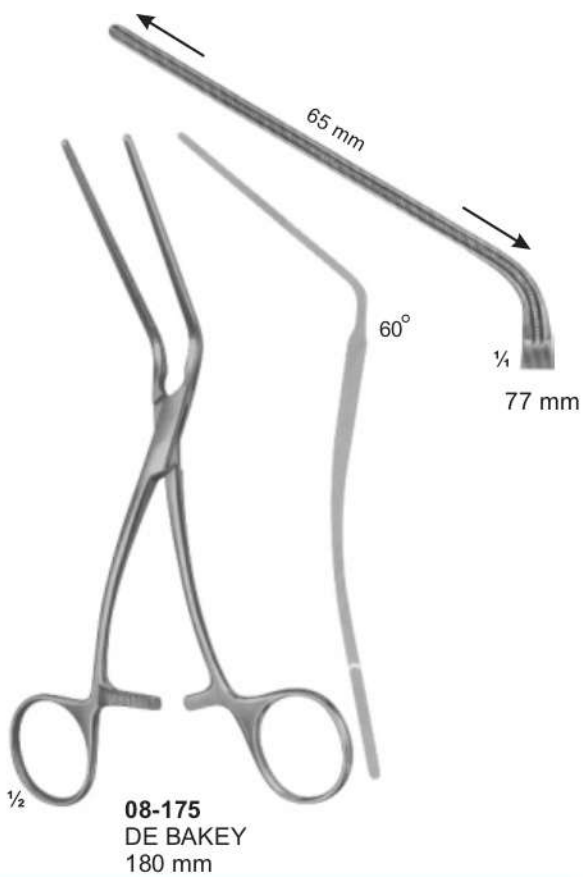
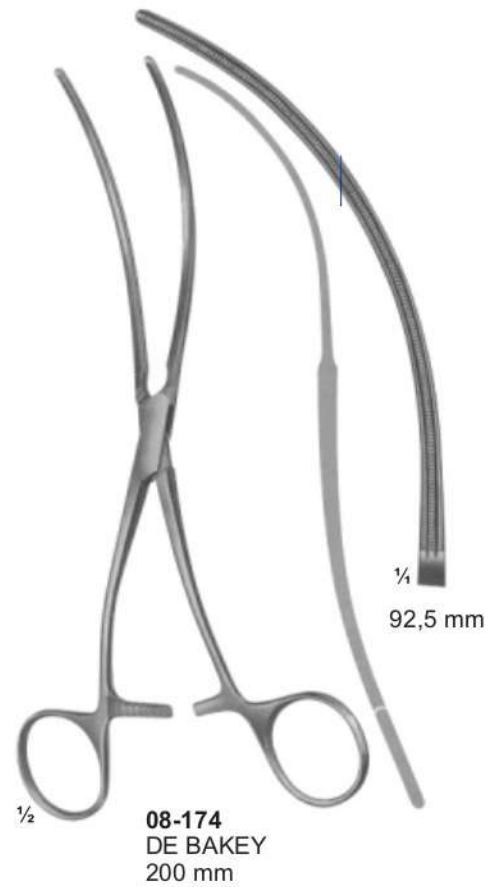
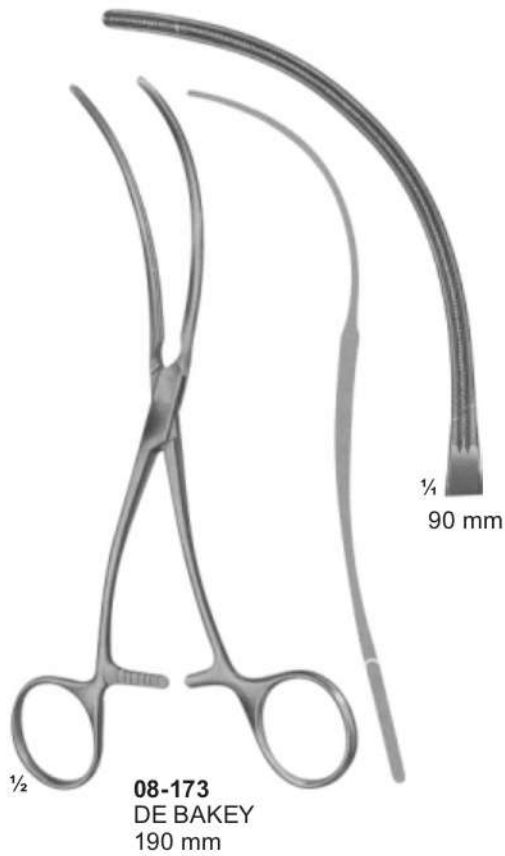

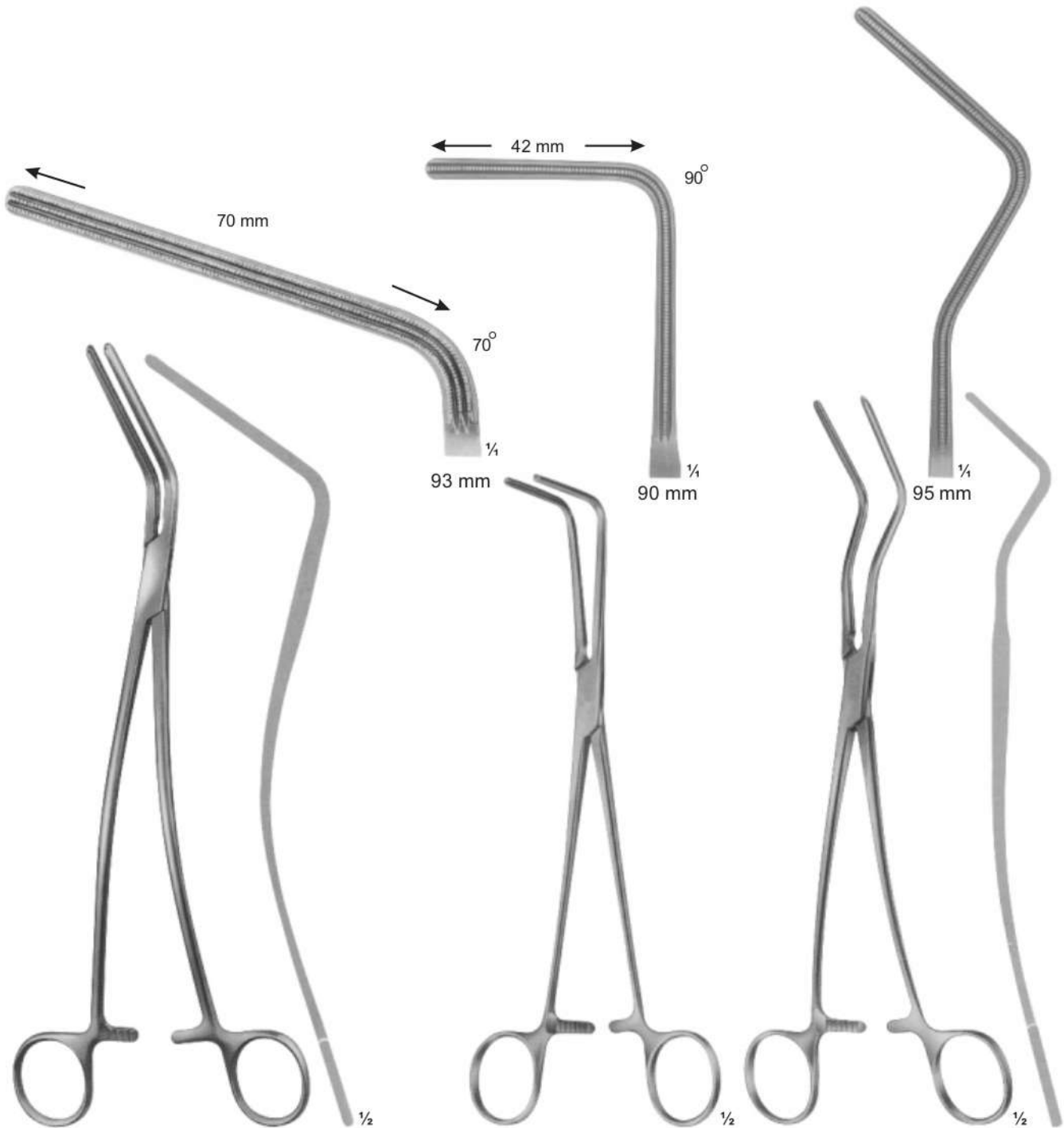
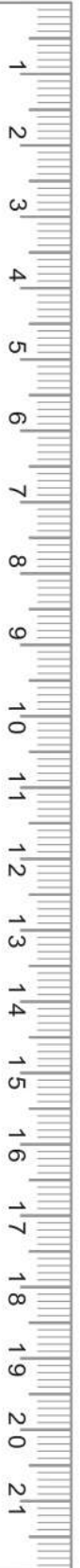

**08-178**  
DE BAKEY  
240 mm

**08-179**  
LEES  
220 mm

**08-180**  
LEES  
245 mm

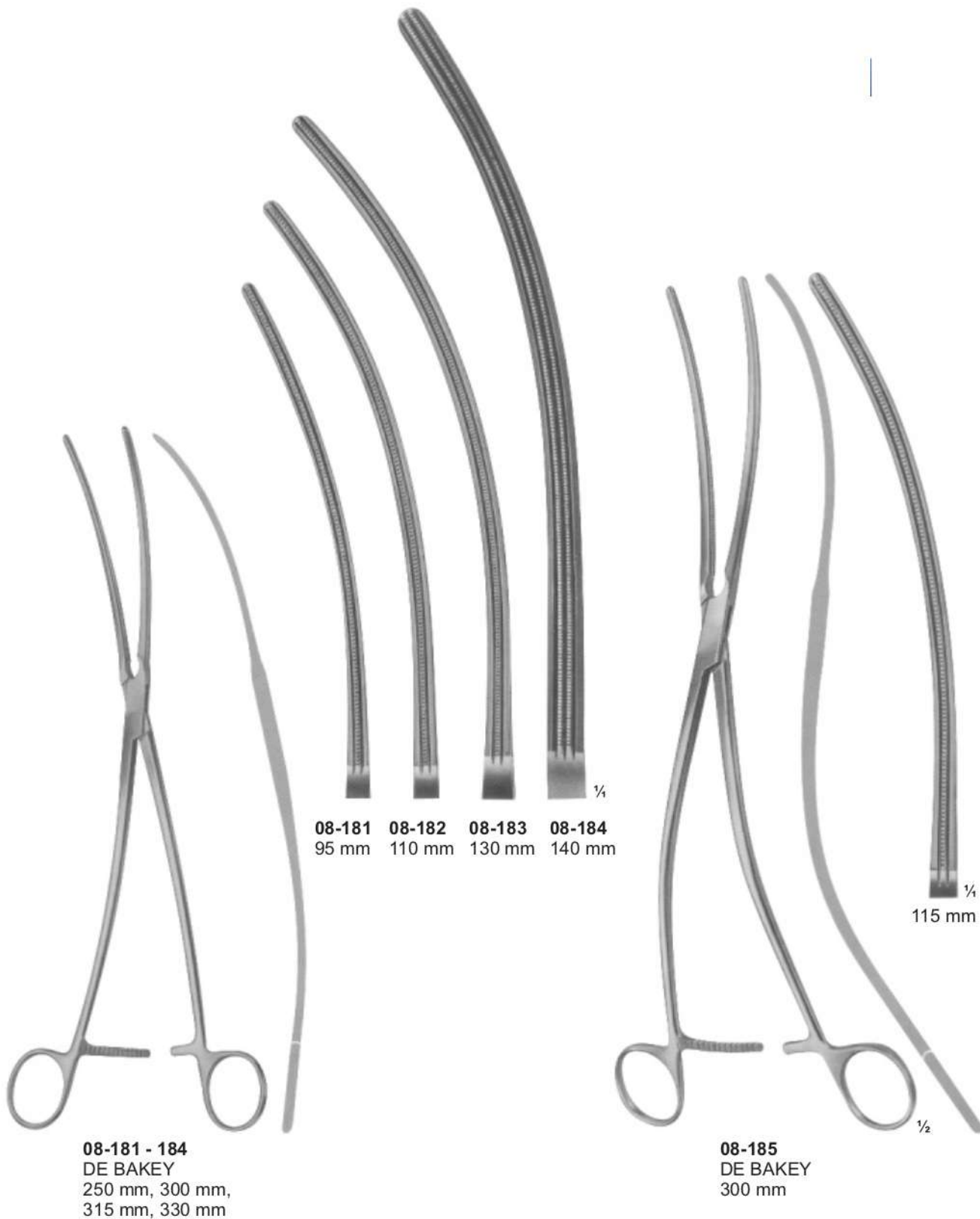

**08-181 - 184**  
 DE BAKEY  
 250 mm, 300 mm,  
 315 mm, 330 mm

**08-181** 95 mm  
**08-182** 110 mm  
**08-183** 130 mm  
**08-184** 140 mm

115 mm

**08-185**  
 DE BAKEY  
 300 mm

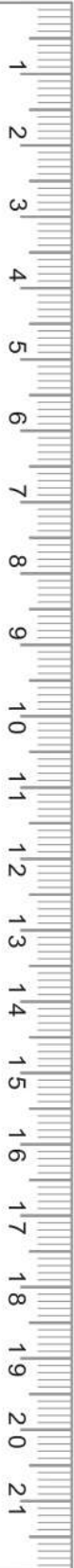

**08-186**  
DIETHRICH  
210 mm

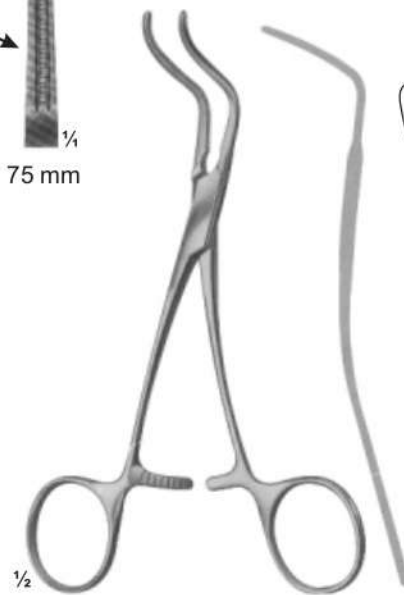
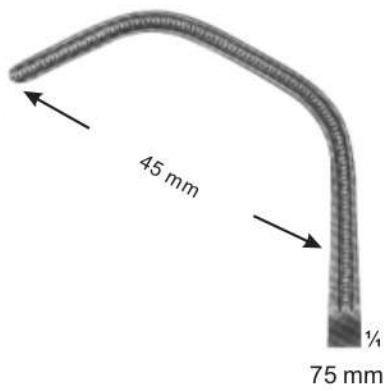

**08-187**  
SUBRAMANIAN  
155 mm

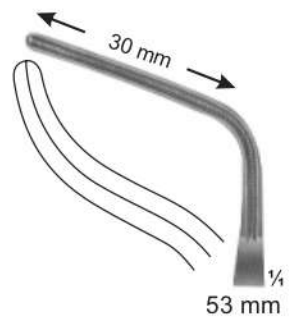

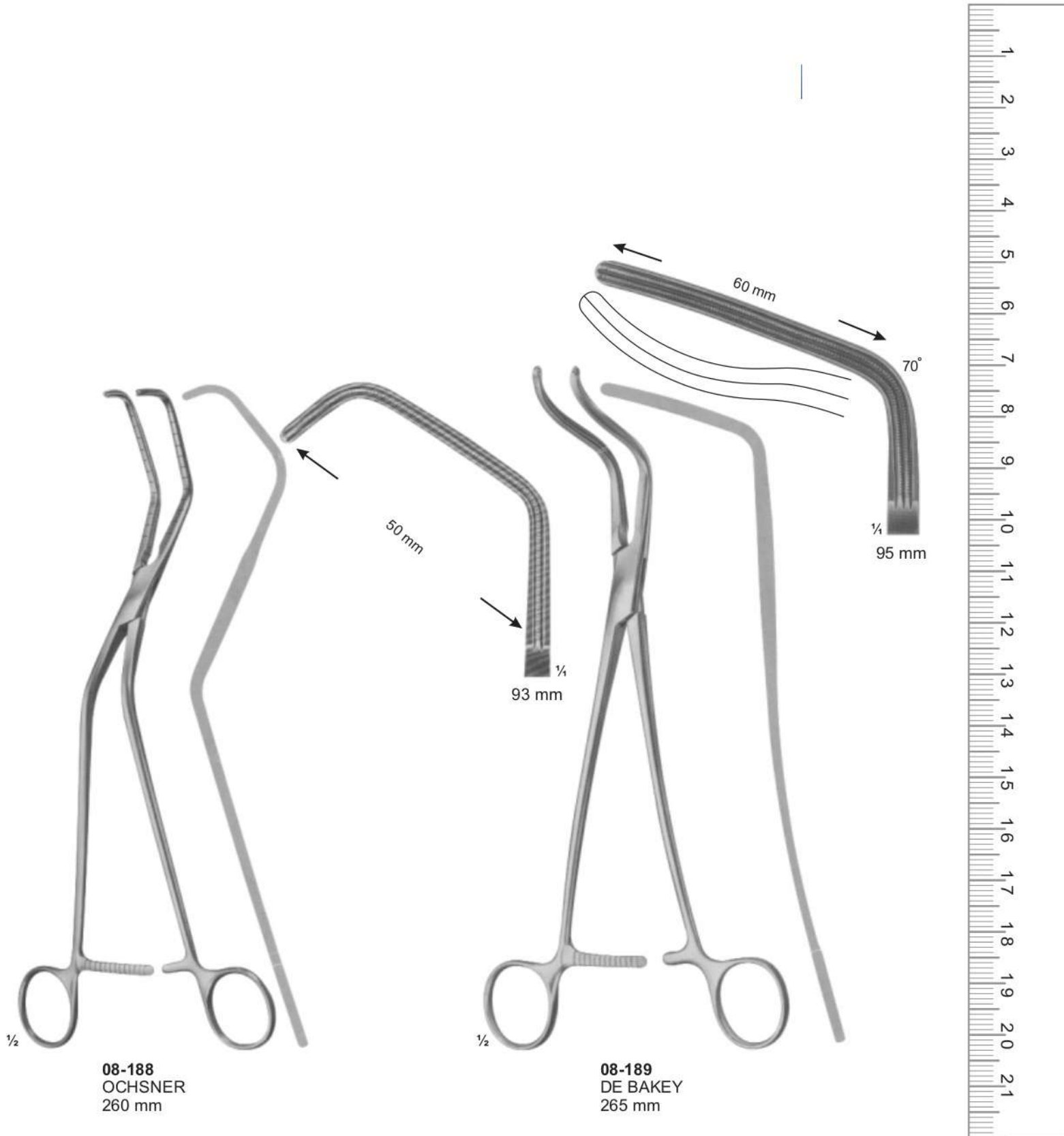

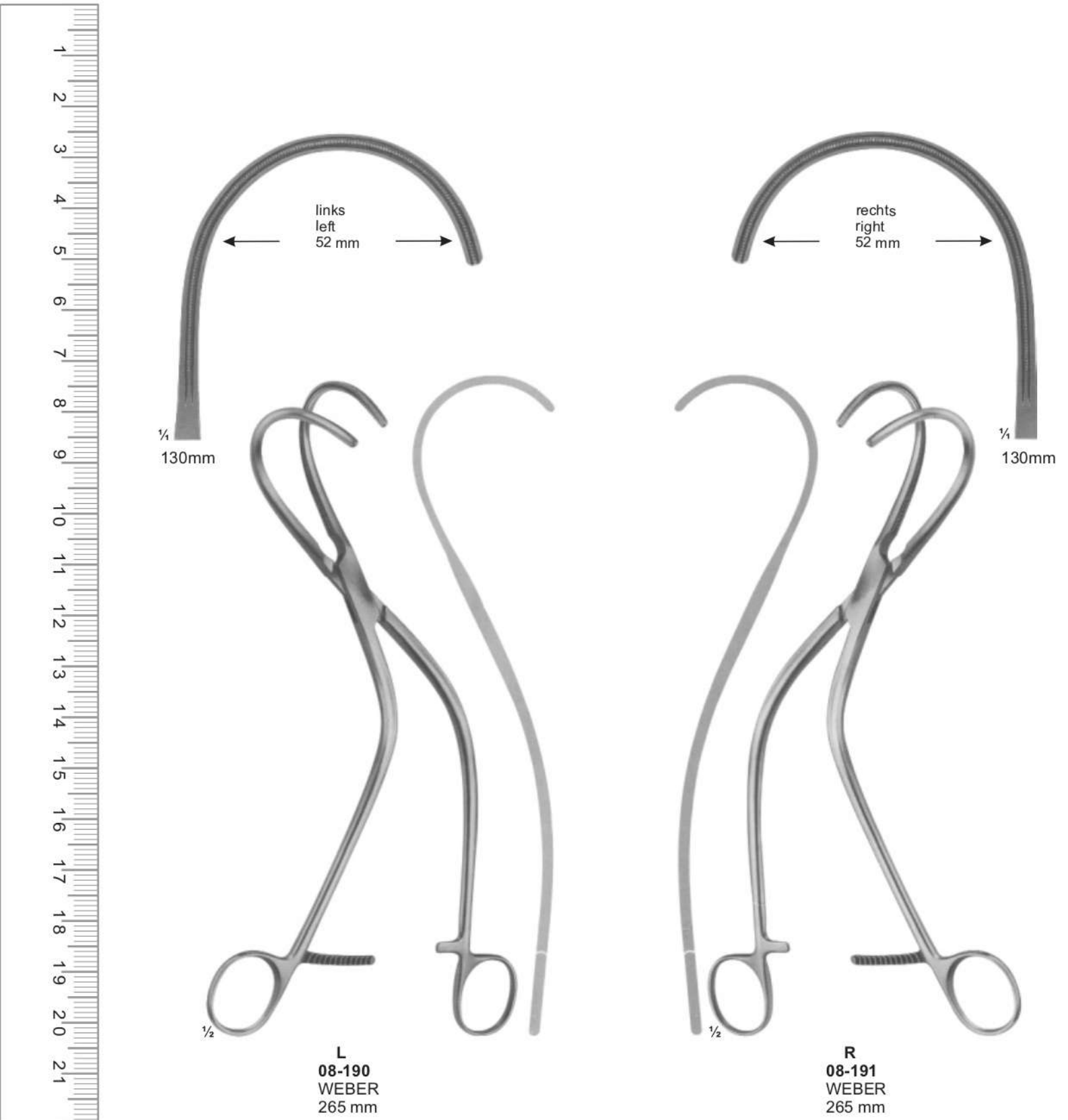



Aorta-anastomosis Clamps  
Aorta-anastomose Schellen  
Anastomosis Aorto-abrazaderas



08-192 - 195  
DE BAKEY

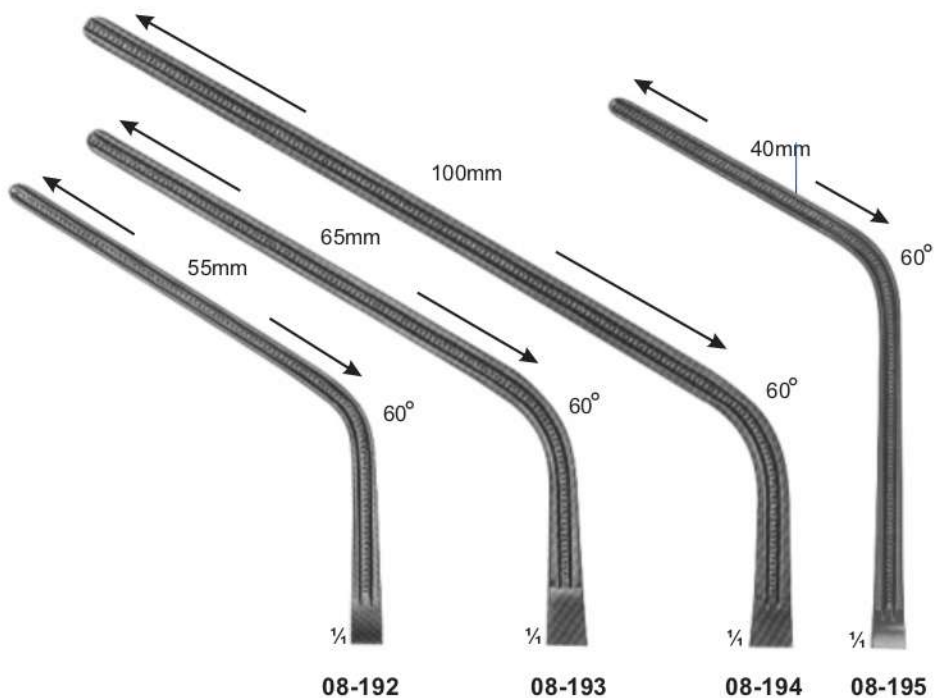

Total Length:	230 mm	280 mm	305 mm	240 mm
Length of jaws:	85 mm	100 mm	135 mm	93 mm



08-196 - 199  
DE BAKEY

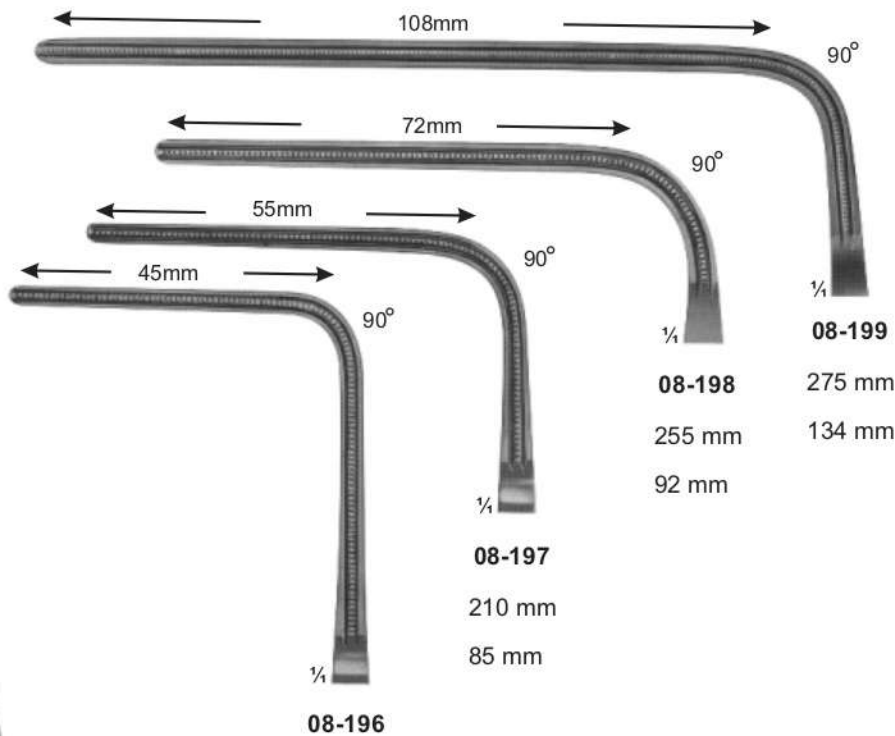

Total Length:	225 mm
Length of jaws:	93 mm



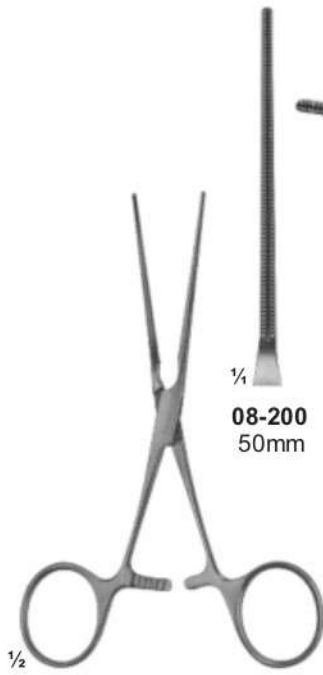
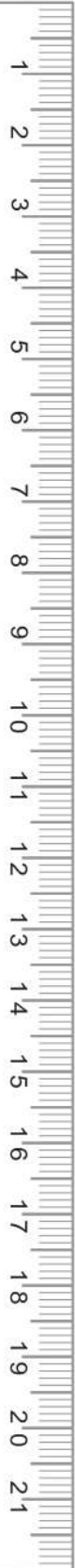

**08-200**  
50mm

**08-200 - 201**  
COOLEY  
125 mm, 115 mm

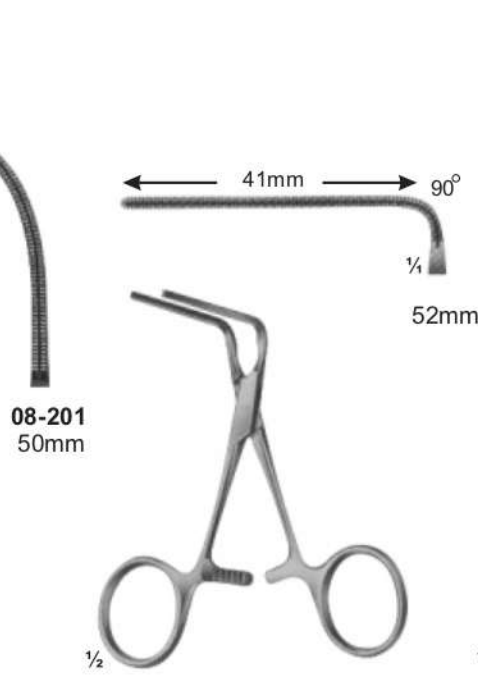

**08-201**  
50mm

**08-202**  
COOLEY  
100 mm

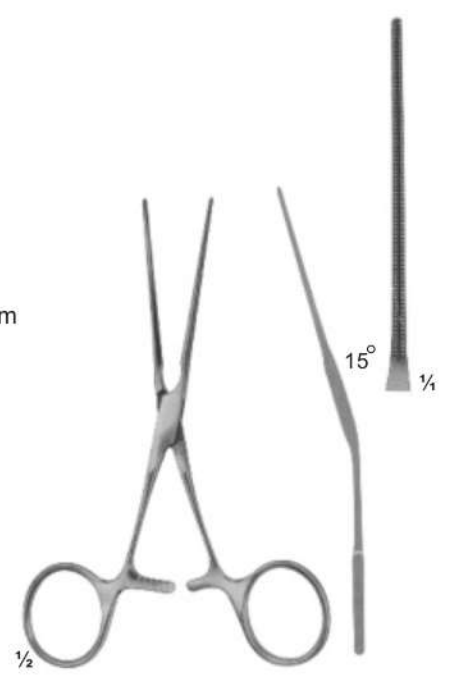

**08-203**  
COOLEY  
125 mm

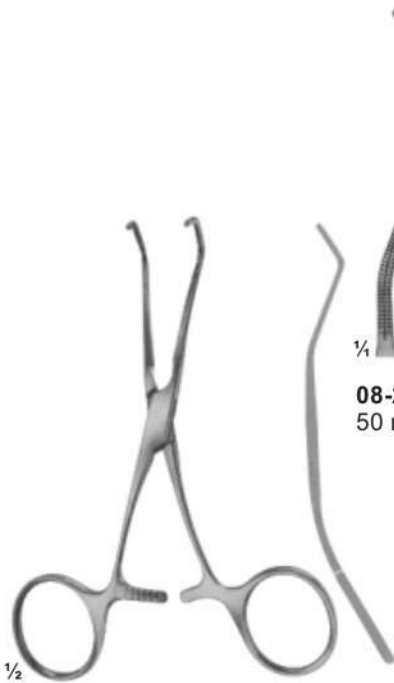

**08-204**  
50 mm

**08-204 - 205**  
COOLEY  
120 mm, 115 mm

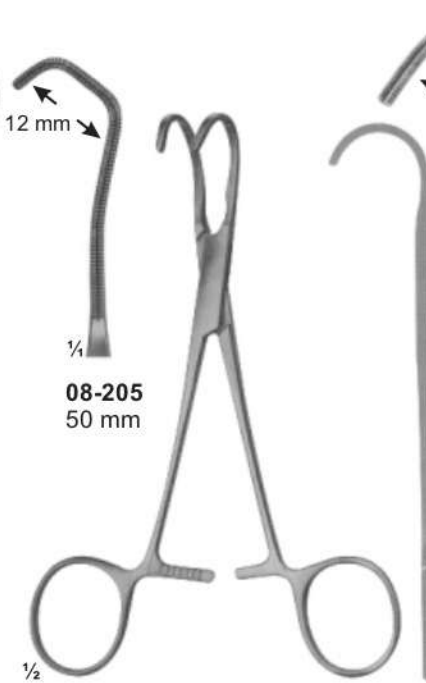

**08-205**  
50 mm

**08-206 - 207**  
COOLEY-BACK  
150 mm, 115 mm

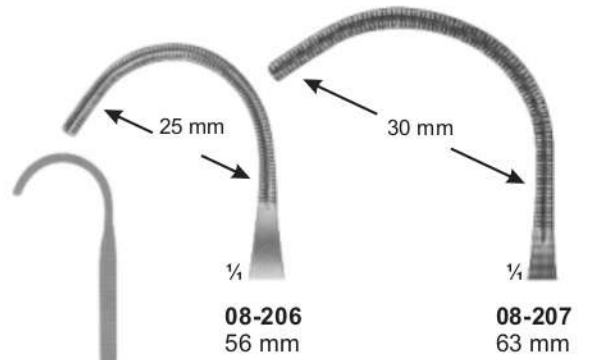

**08-206**  
56 mm

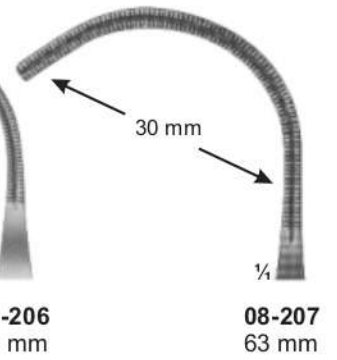

**08-207**  
63 mm



**Aorta-anastomosis Clamps**  
**Aorta-anastomose Schellen**  
**Anastomosis Aorto-abrazaderas**

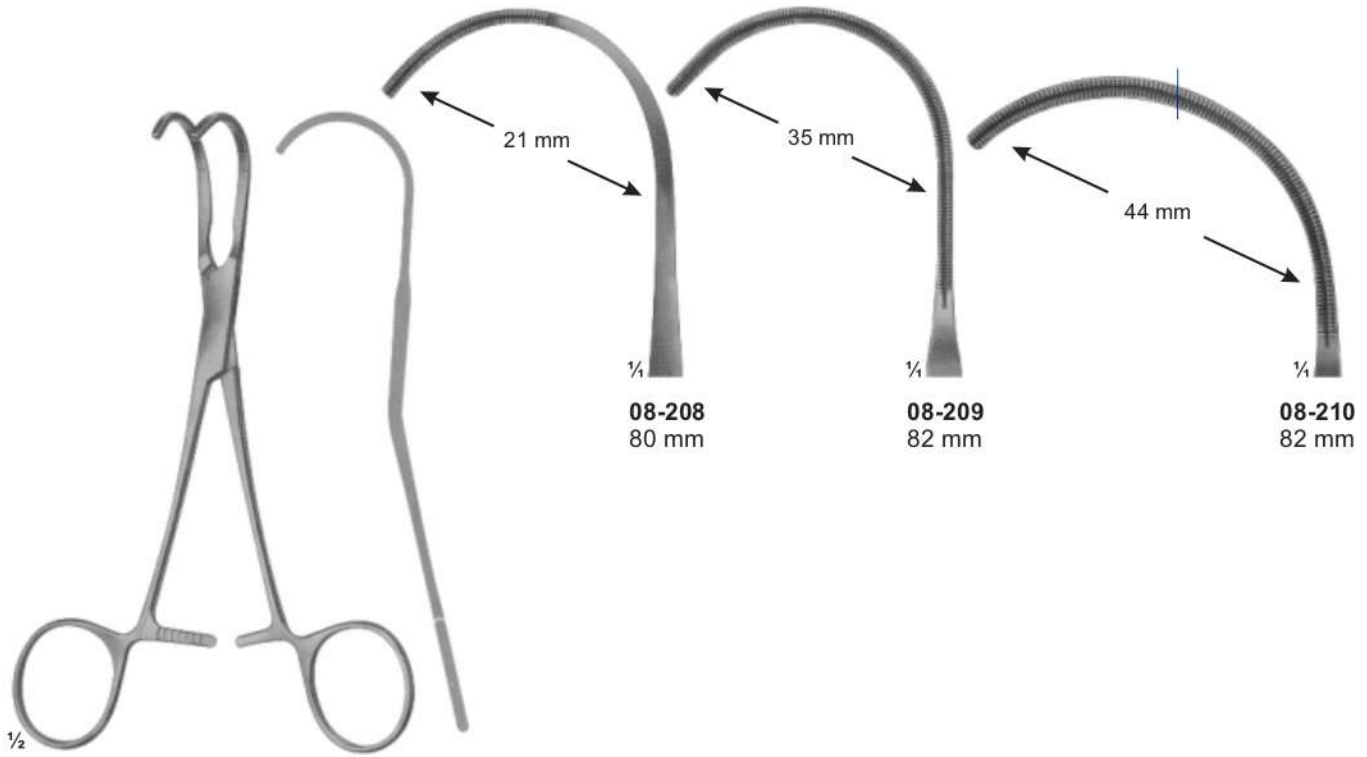

**08-208 - 210**  
**COOLEY**  
170 mm

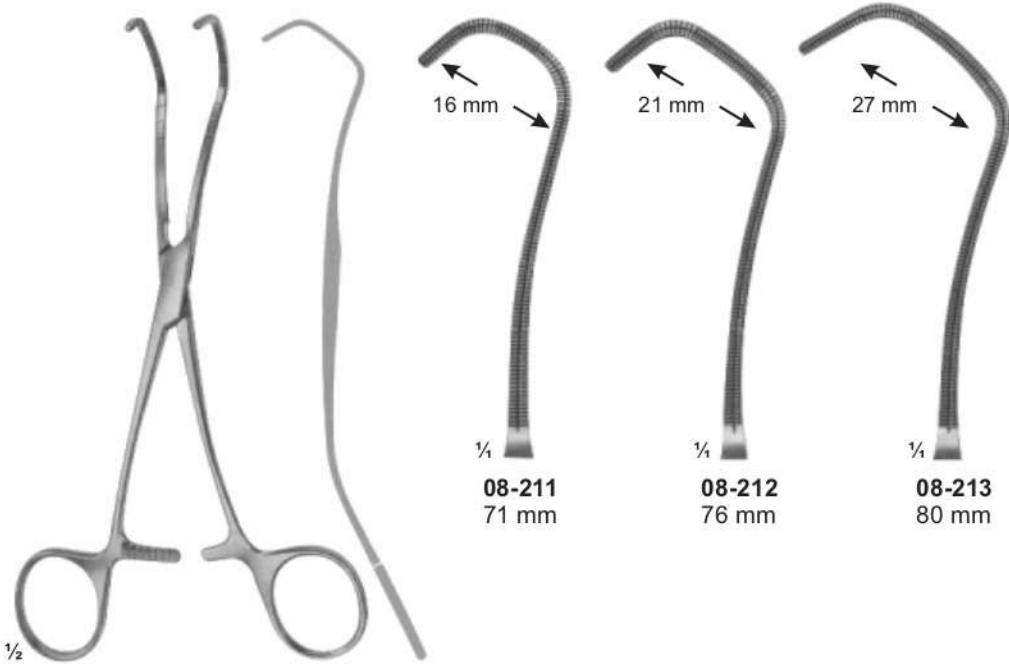

**08-211 - 213**  
**DERRA-COOLEY**  
170 mm, 175 mm, 175mm

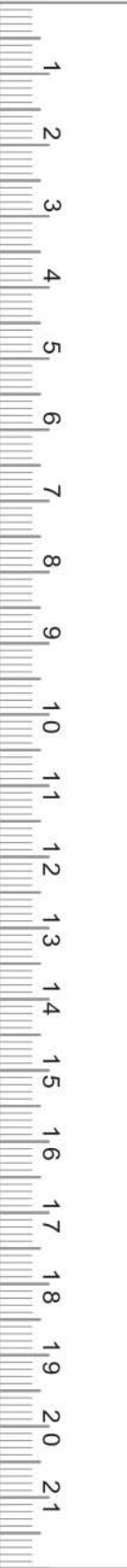

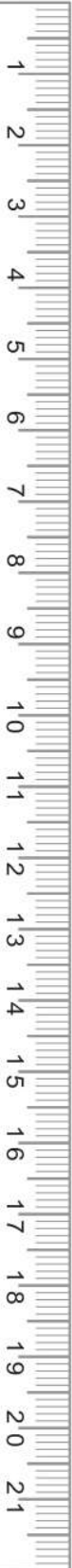

**08-214 - 217**  
COOLEY  
165 mm, 165 mm  
175 mm, 180 mm

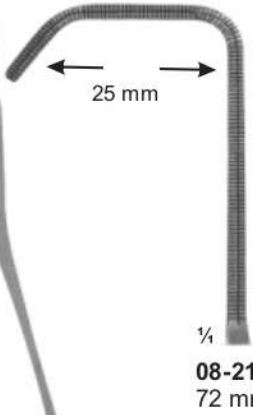

¼  
**08-214**  
72 mm

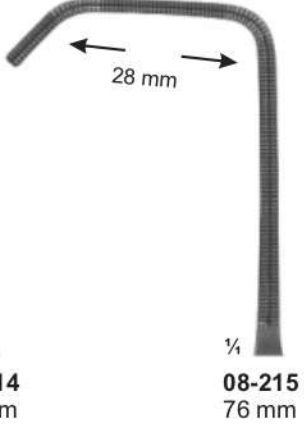

¼  
**08-215**  
76 mm

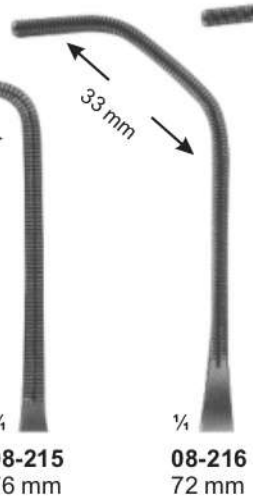

¼  
**08-216**  
72 mm

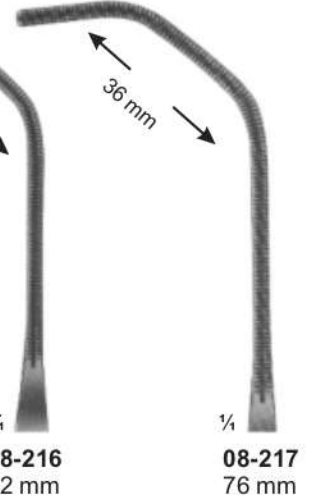

¼  
**08-217**  
76 mm

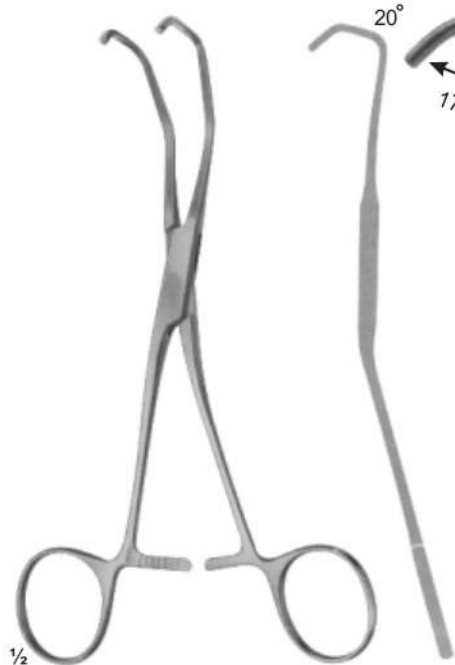

**08-218**  
COOLEY  
170 mm

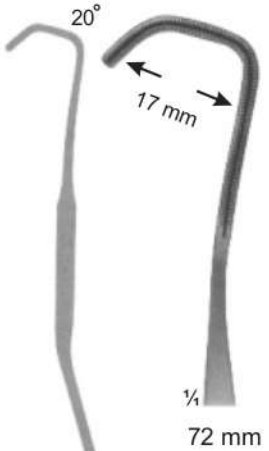

¼  
72 mm

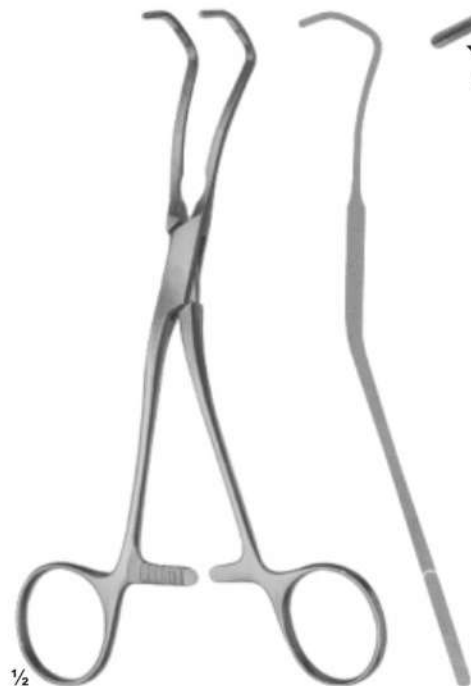

**08-219**  
COOLEY  
175 mm



¼  
74mm



**Aorta-anastomosis Clamps**  
Aorta-anastomose Schellen  
Anastomosis Aorto-abrazaderas

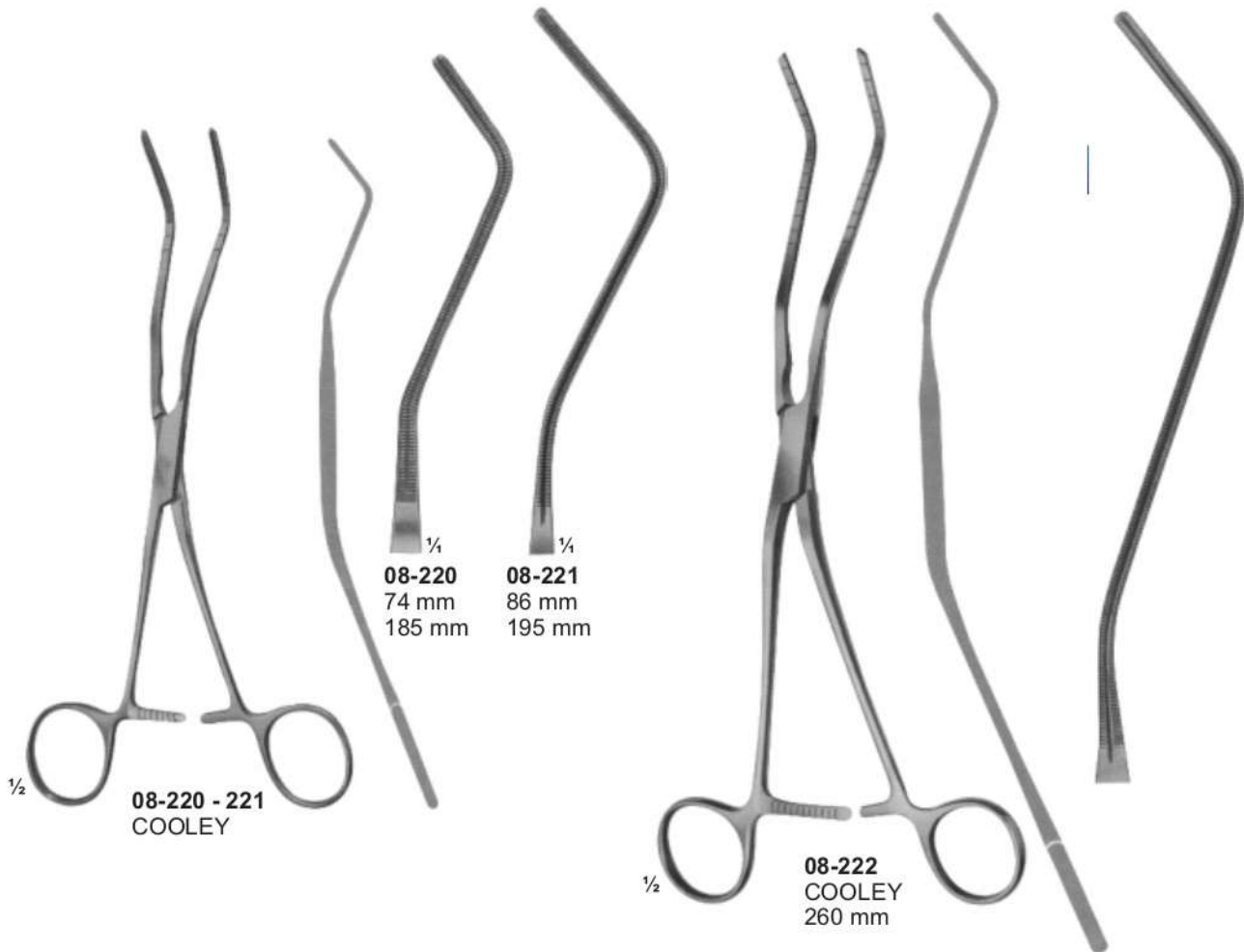

**08-220 - 221**  
COOLEY



**08-220**  
74 mm  
185 mm

**08-221**  
86 mm  
195 mm



**08-222**  
COOLEY  
260 mm

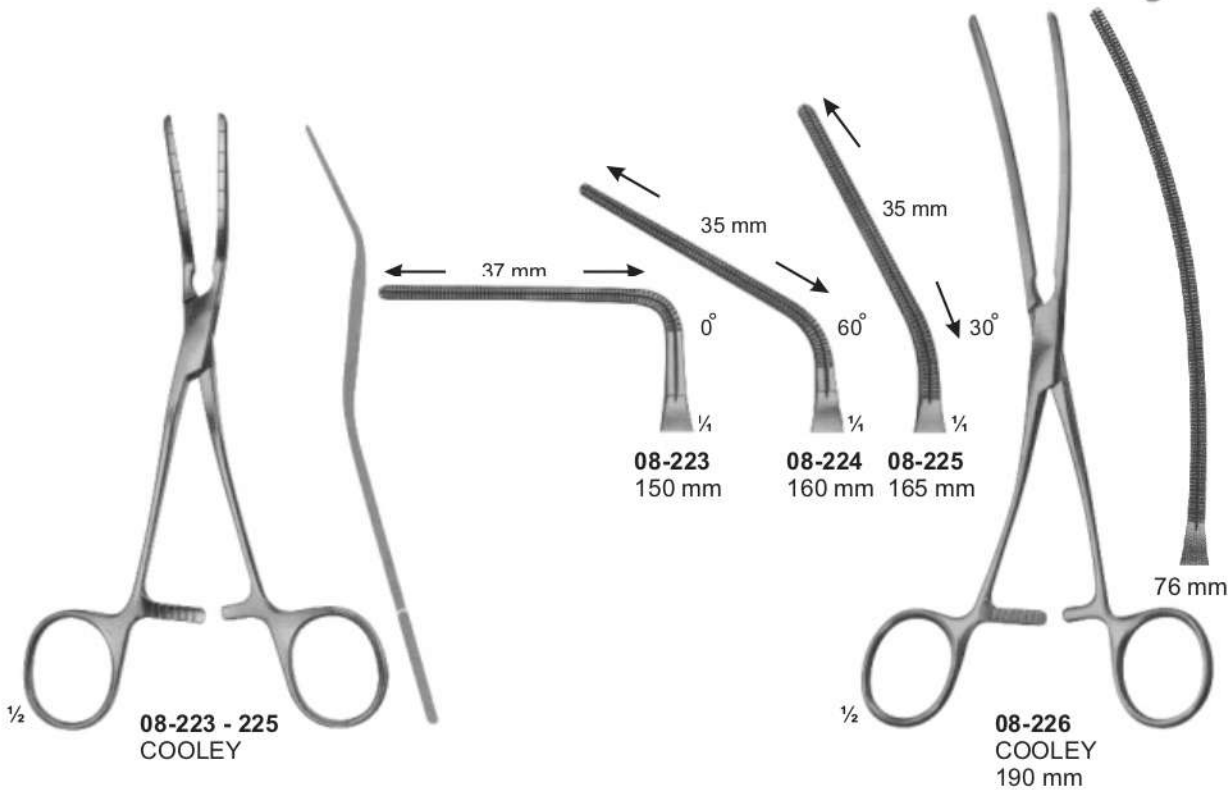

**08-223 - 225**  
COOLEY

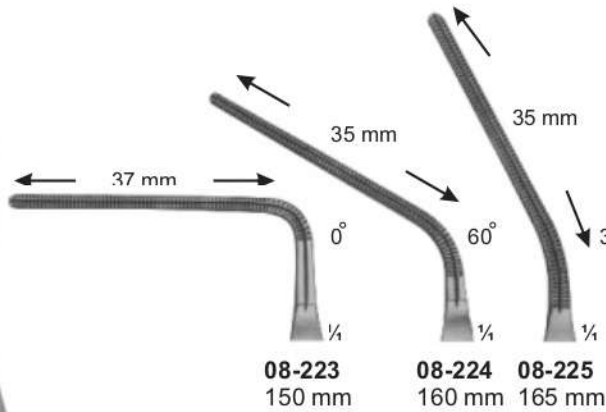

**08-223**  
150 mm

**08-224**  
160 mm

**08-225**  
165 mm

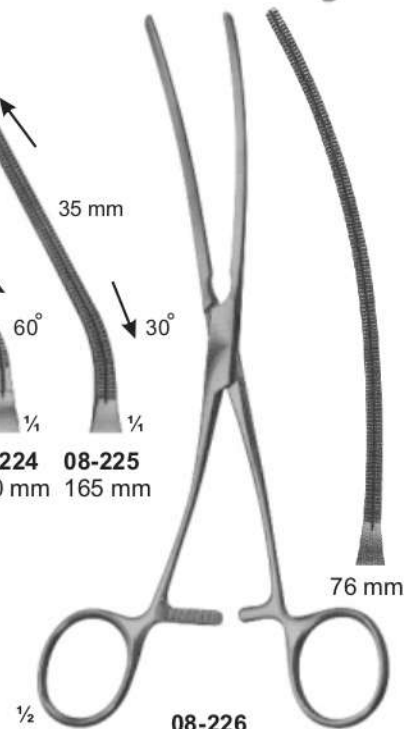

**08-226**  
COOLEY  
190 mm

76 mm

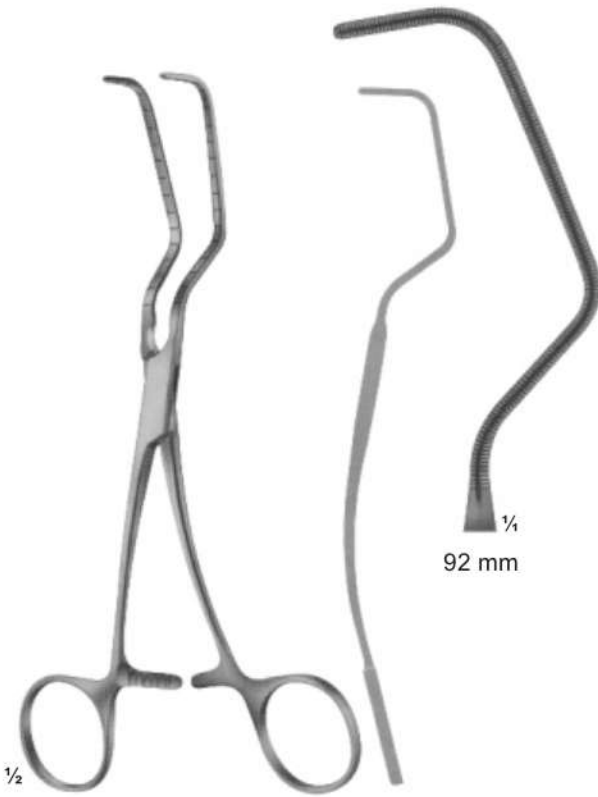
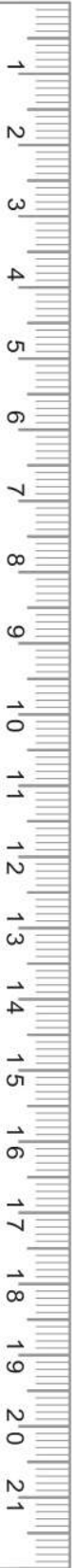

1/2

**08-227**  
PARRY-COOLEY  
185 mm

92 mm  
1/4

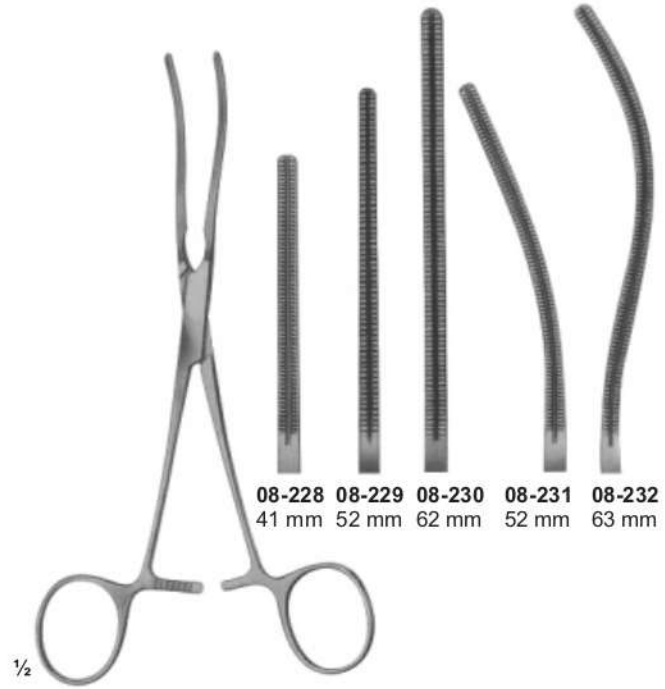

1/2

**08-228 - 232**  
COOLEY  
160 mm, 170 mm, 180 mm

**08-228** 41 mm  
**08-229** 52 mm  
**08-230** 62 mm  
**08-231** 52 mm  
**08-232** 63 mm

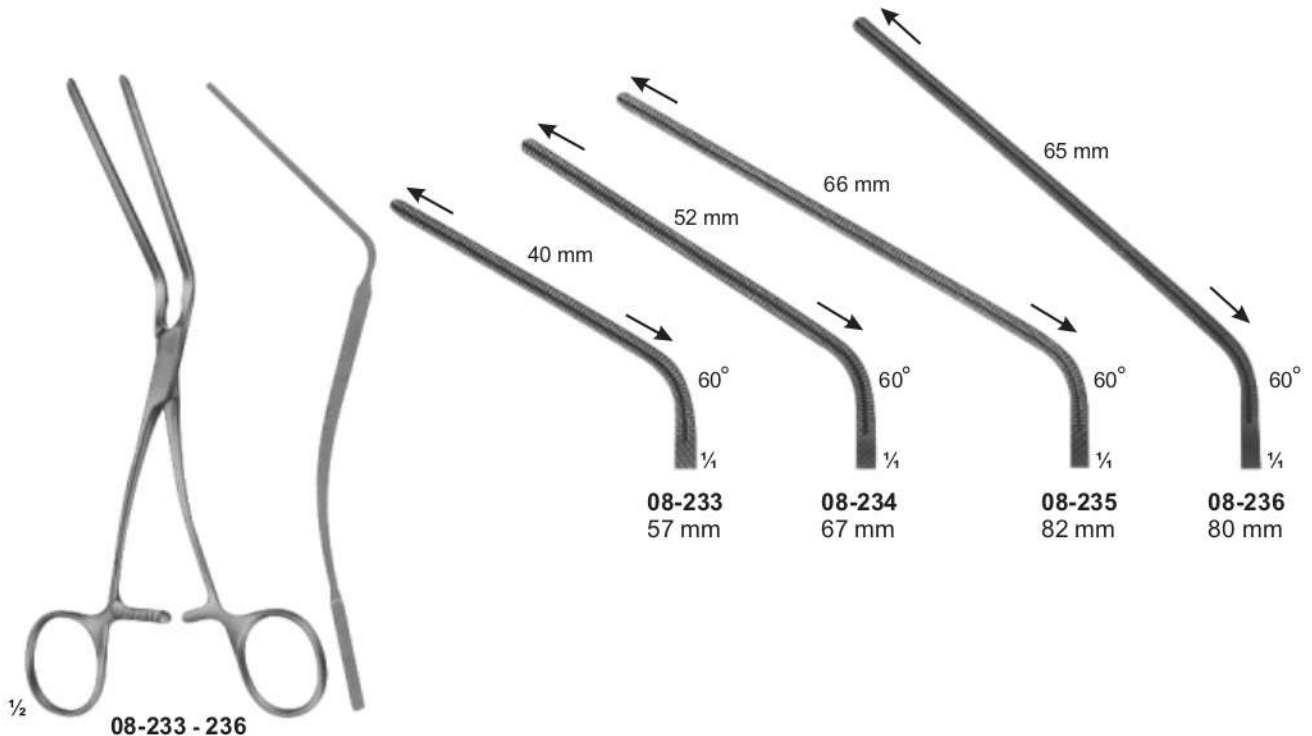

1/2

**08-233 - 236**  
165 mm, 170 mm,  
185 mm, 185 mm

**08-233**  
57 mm

**08-234**  
67 mm

**08-235**  
82 mm

**08-236**  
80 mm

40 mm

52 mm

66 mm

65 mm

60°

60°

60°

60°

1/4

1/4

1/4

1/4

**Multi-purpose Clamps**  
**Mehrzweckklemmen**  
**Multi-purpose Pinzas**



**MATU BROTHERS**  
**SURGICAL**



1/2

- DARDIK**  
**08-237** 150 mm  
**08-238** 150 mm  
**08-239** 150 mm  
**08-240** 145 mm  
**08-241** 130 mm

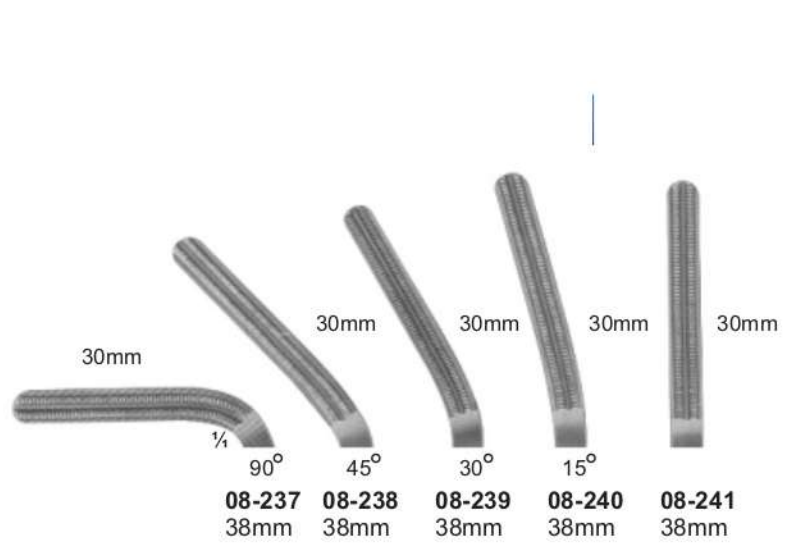

- 08-237** 38mm  
**08-238** 38mm  
**08-239** 38mm  
**08-240** 38mm  
**08-241** 38mm



1/2

- DARDIK**  
**08-242** 170 mm  
**08-243** 170 mm  
**08-244** 170 mm  
**08-245** 160 mm  
**08-246** 135 mm

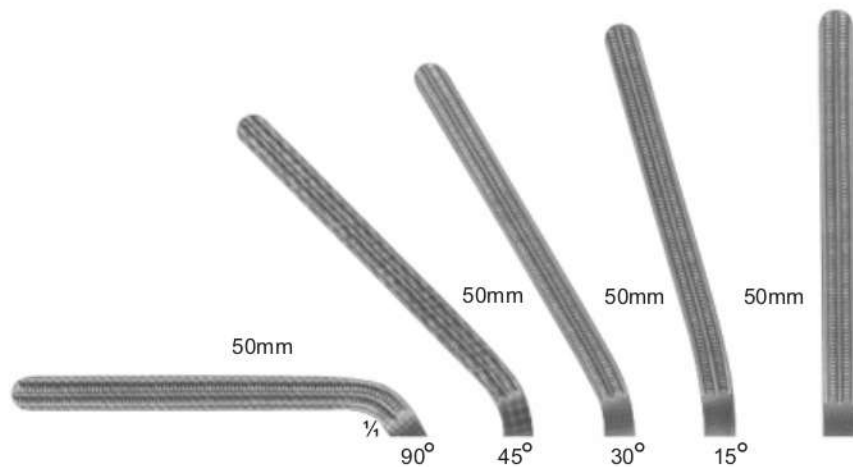

- 08-242** 58mm  
**08-243** 58mm  
**08-244** 58mm  
**08-245** 58mm  
**08-246** 58mm



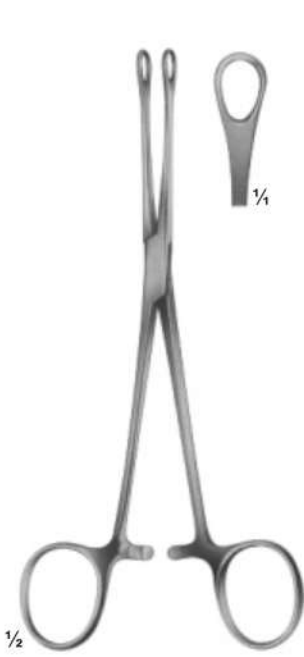
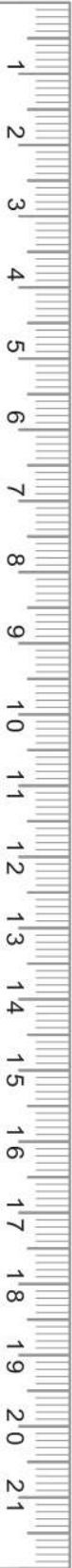

**08-247  
WILLIAMS  
160 mm**



**08-248  
TUTTLE  
230 mm**



**08-249  
NELSON  
230 mm**

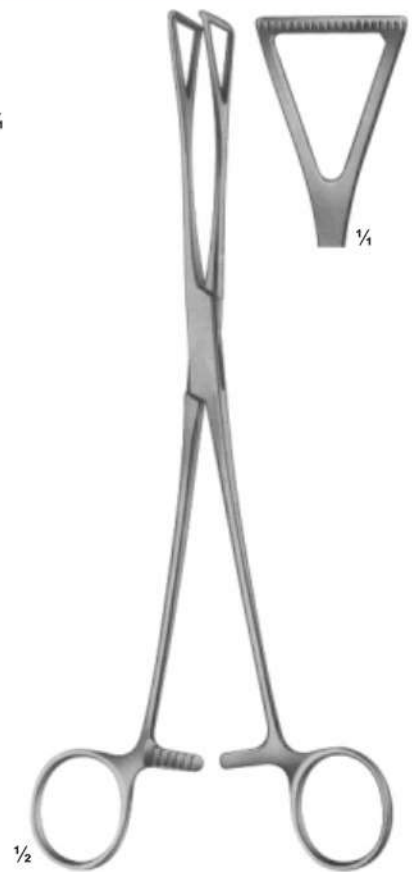

**08-250  
DUVAL  
230 mm**



**BABCOCK  
08-251 170 mm  
08-252 215 mm  
08-253 220 mm**



**08-251**

**08-252**



**08-253**

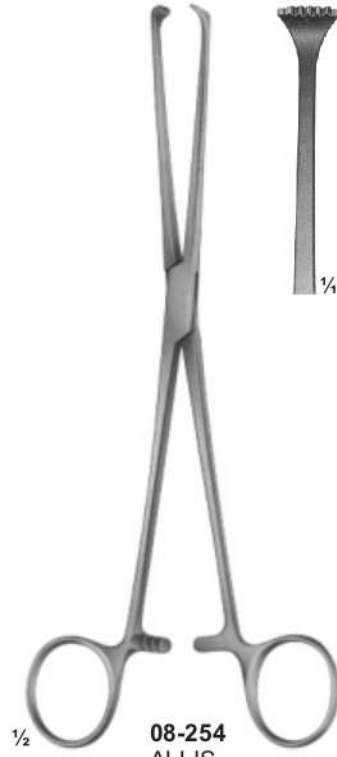

**08-254  
ALLIS  
220 mm**



**08-255**  
SATINSKY  
265 mm



**08-256**  
SATINSKY  
265 mm

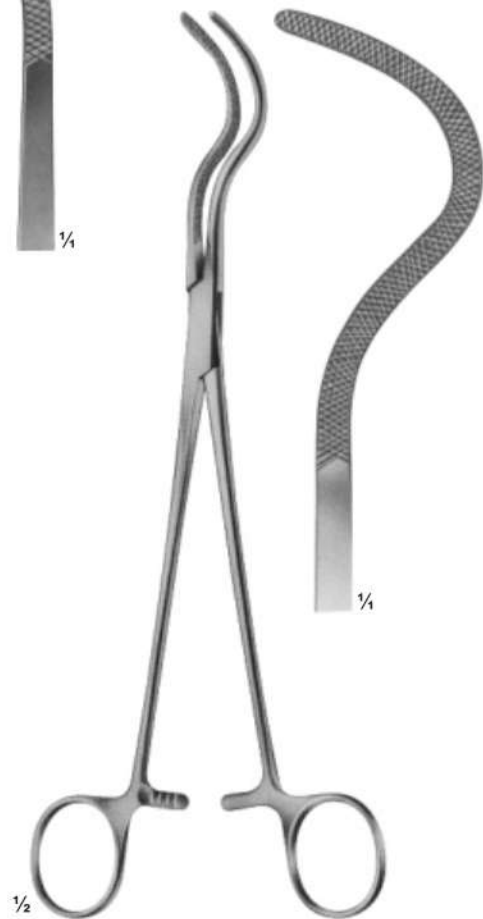

**08-257**  
HARKEN  
240 mm





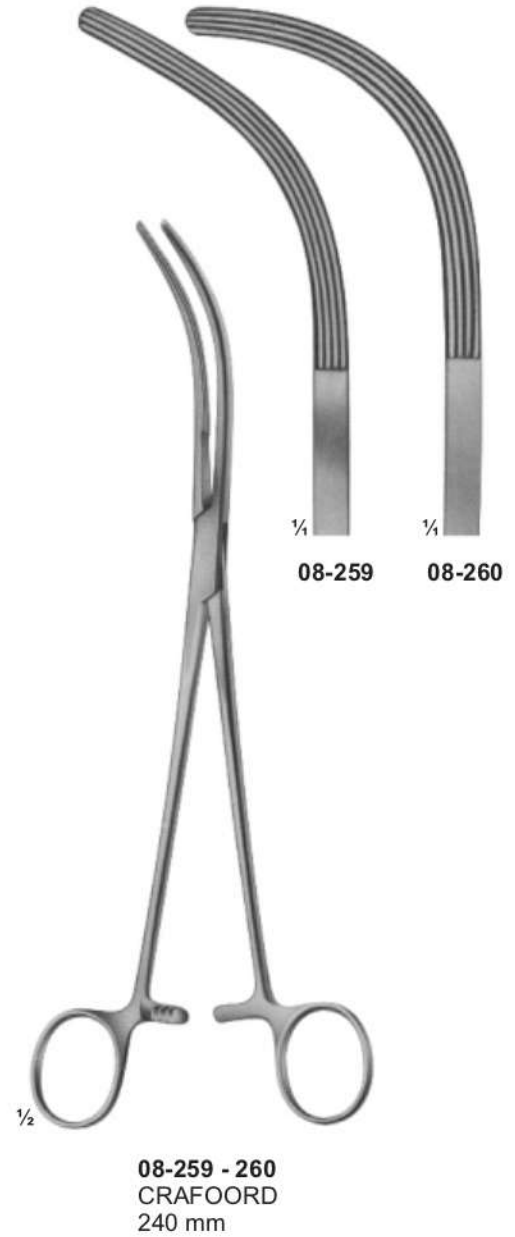
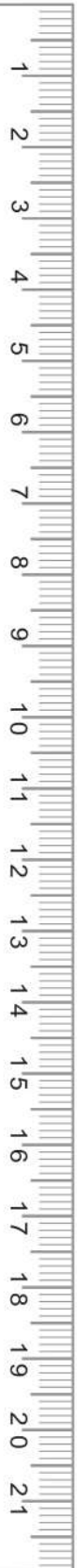



**08-261**  
PRICE THOMAS  
225 mm



**08-262**  
jaws with pins

**08-263**  
jaws with pins

**08-262 - 263**  
PRICE THOMAS  
225 mm

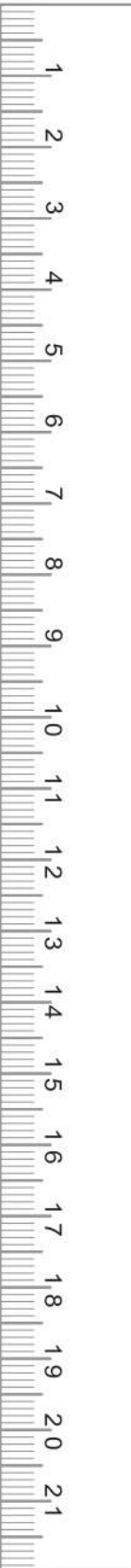

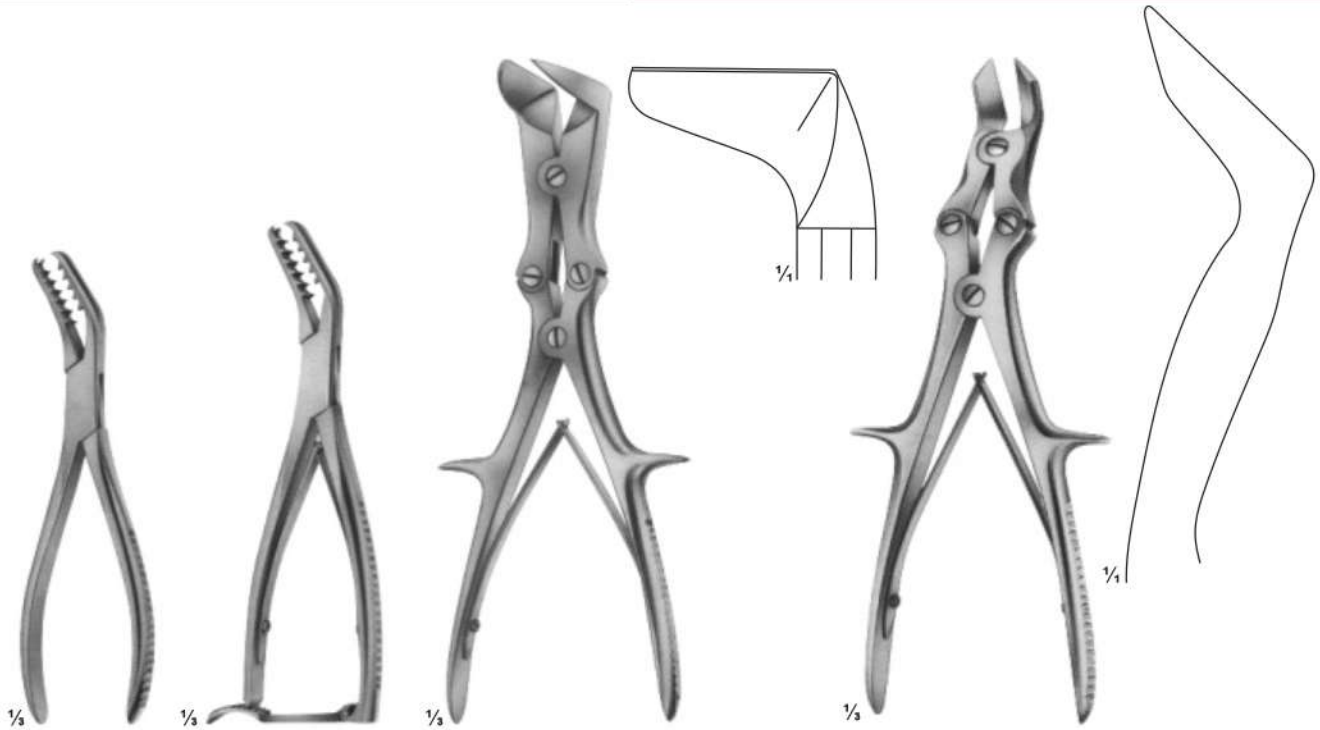

**08-264**  
SEMB  
Rib-and Bone  
Holding forceps  
190 mm

**08-265**  
SEMB  
Rib-and Bone  
Holding forceps  
190 mm

**08-266**  
LISTON-STILLE  
265 mm

**08-267**  
LISTON-KEY-HORSLEY  
255 mm

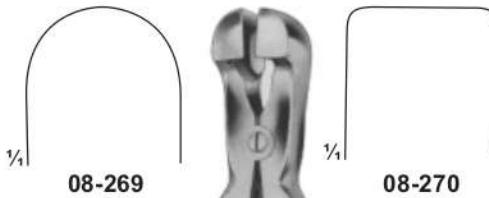

**08-269**

**08-270**

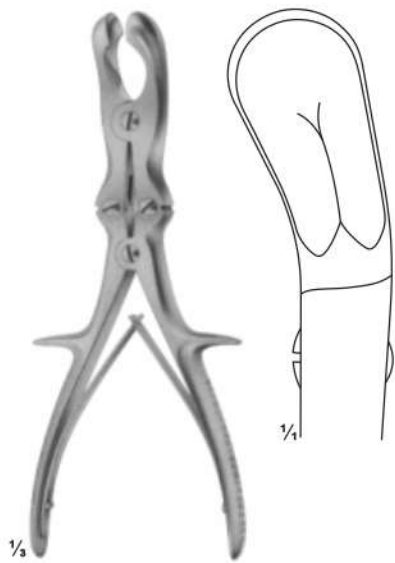

**08-268**  
SEME  
Rib Rongeur to shorten  
the rib stumps  
240 mm



**08-269 - 270**  
SAUERDRUCH-CORYLLOS  
Rib rongeurs to shorten  
the rib stumps  
310 mm

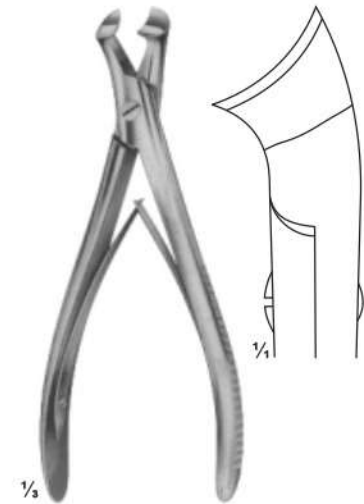

**08-271**  
MARKWALDER  
Rib Rongeur to Round  
the rib stumps  
190 mm

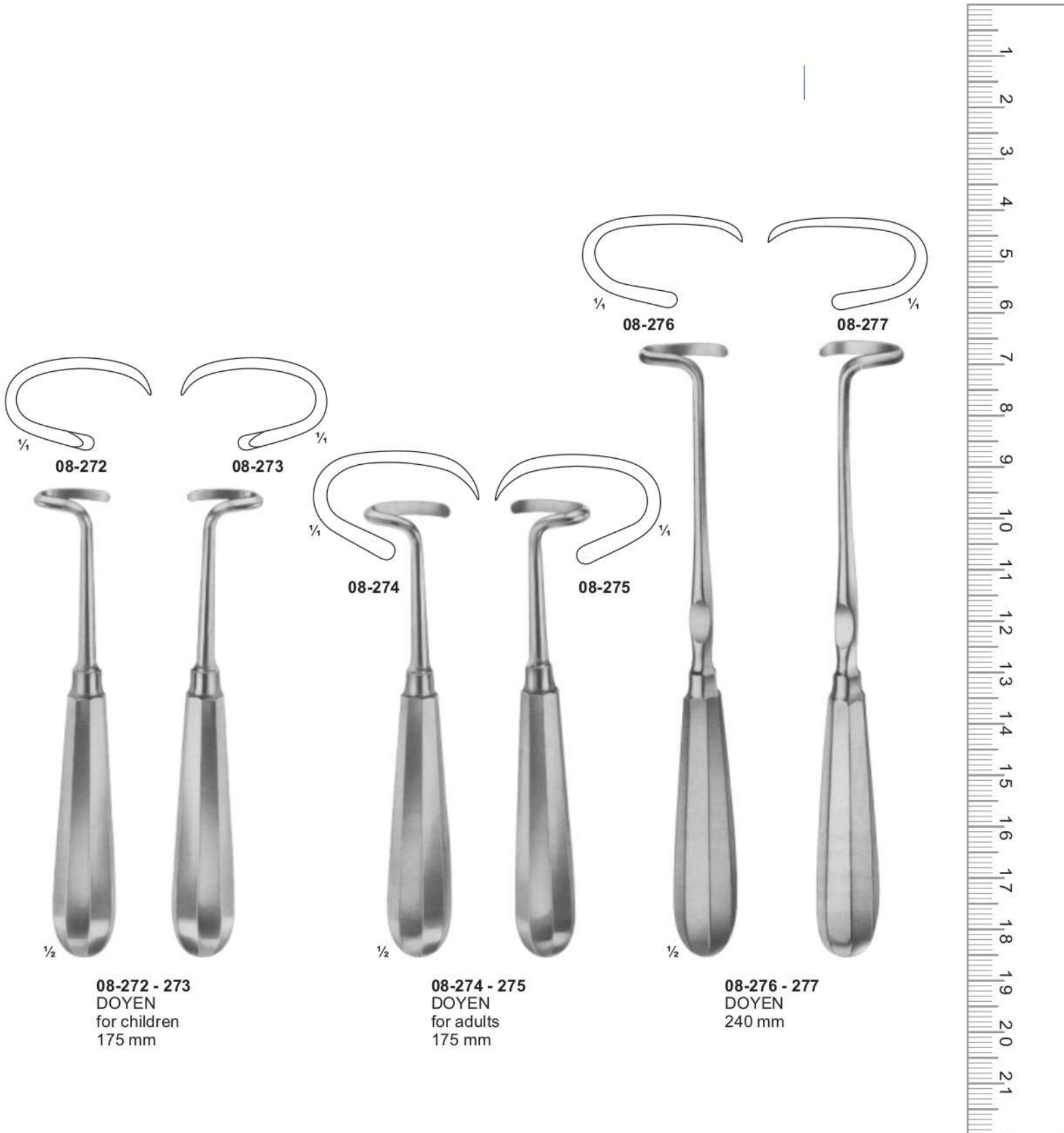

**08-272 - 273**  
 DOYEN  
 for children  
 175 mm

**08-274 - 275**  
 DOYEN  
 for adults  
 175 mm

**08-276 - 277**  
 DOYEN  
 240 mm



1/2  
**08-278-282**  
SEMB  
230 mm



12 mm  
**08-278**  
190 mm



**08-279**



13 mm  
**08-280**

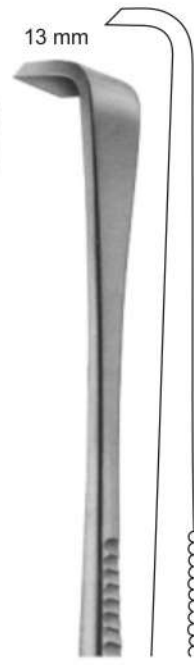

13 mm  
**08-281**

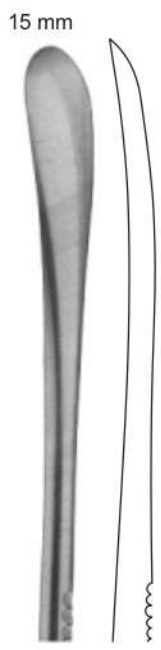

15 mm  
**08-282**

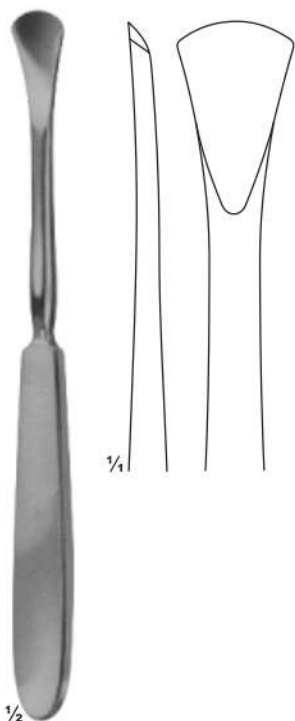

1/2  
**08-283**  
LANGENBECK  
190 mm

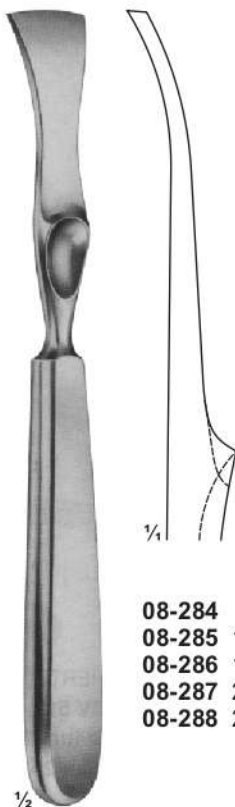

1/4  
**08-284** 5 mm  
**08-285** 10 mm  
**08-286** 15 mm  
**08-287** 20 mm  
**08-288** 25 mm

1/2  
**08-284-288**  
LAMBOTTE  
215 mm

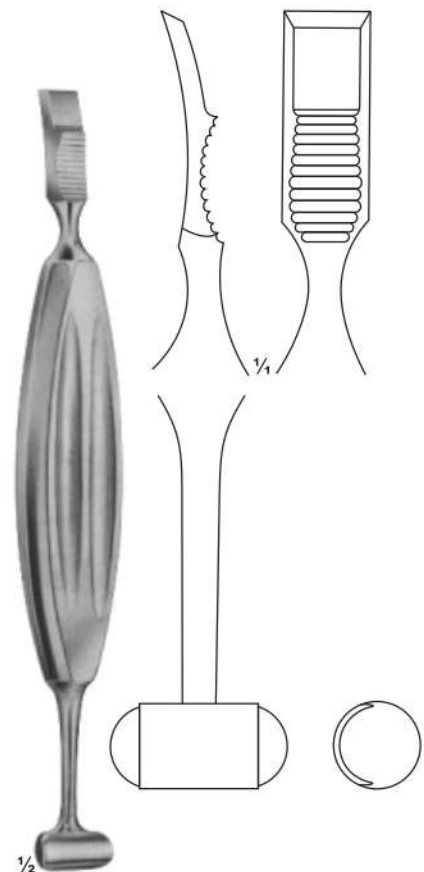

1/2  
**08-289**  
ALEXANDER  
210 mm



**Rib Spreaders**  
Wundsperrer  
Separadores De Costilla

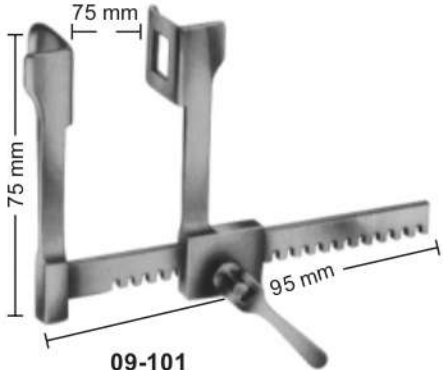

**09-101**  
FINOCHIETTO  
18X21 mm

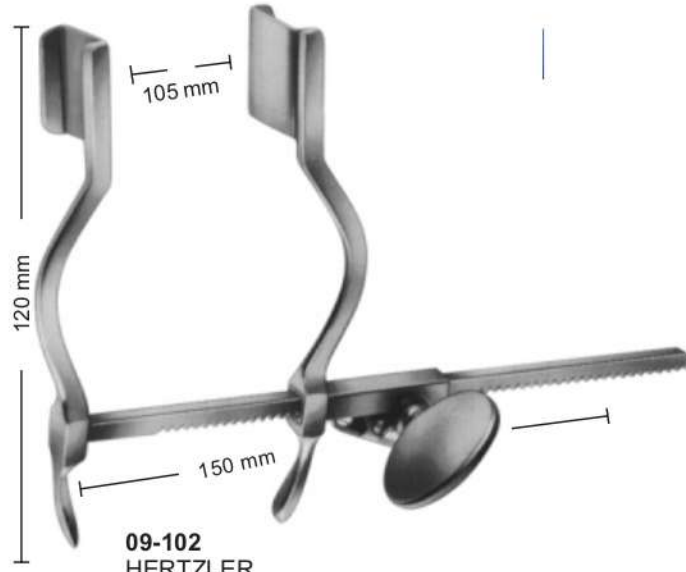

**09-102**  
HERTZLER  
20X25 mm

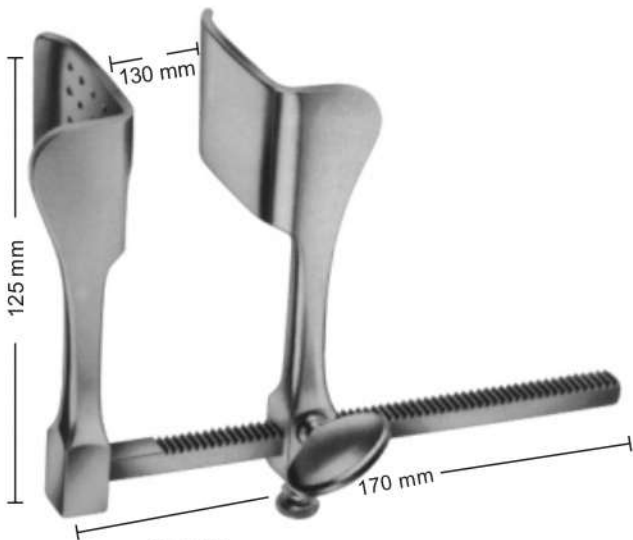

**09-103**  
TUFFIER  
Blades  
43X53 mm

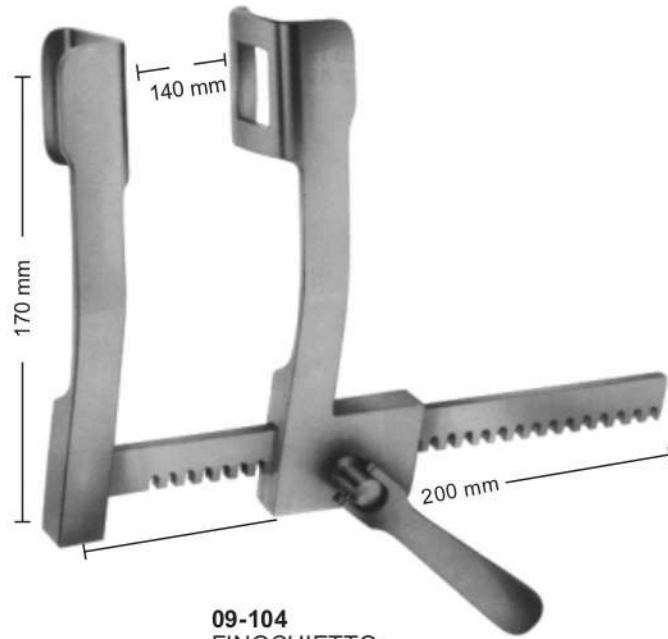

**09-104**  
FINOCHIETTO  
Blades  
36X45 mm

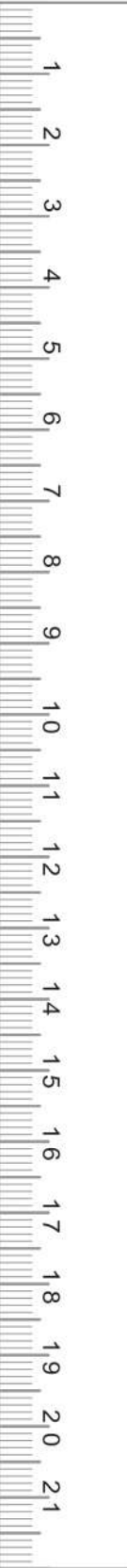

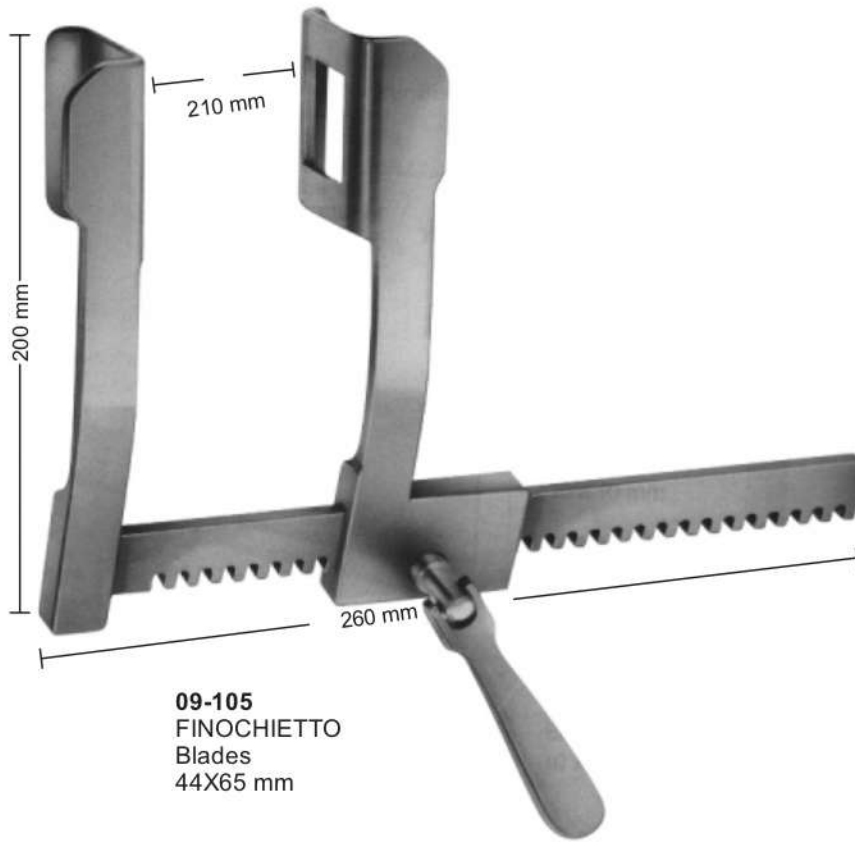
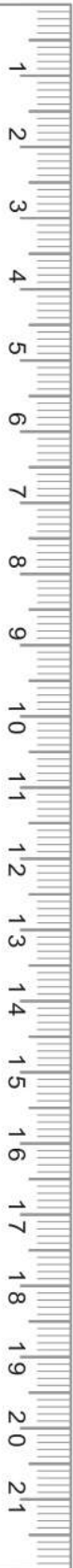

**09-105**  
FINOCHIETTO  
Blades  
44X65 mm

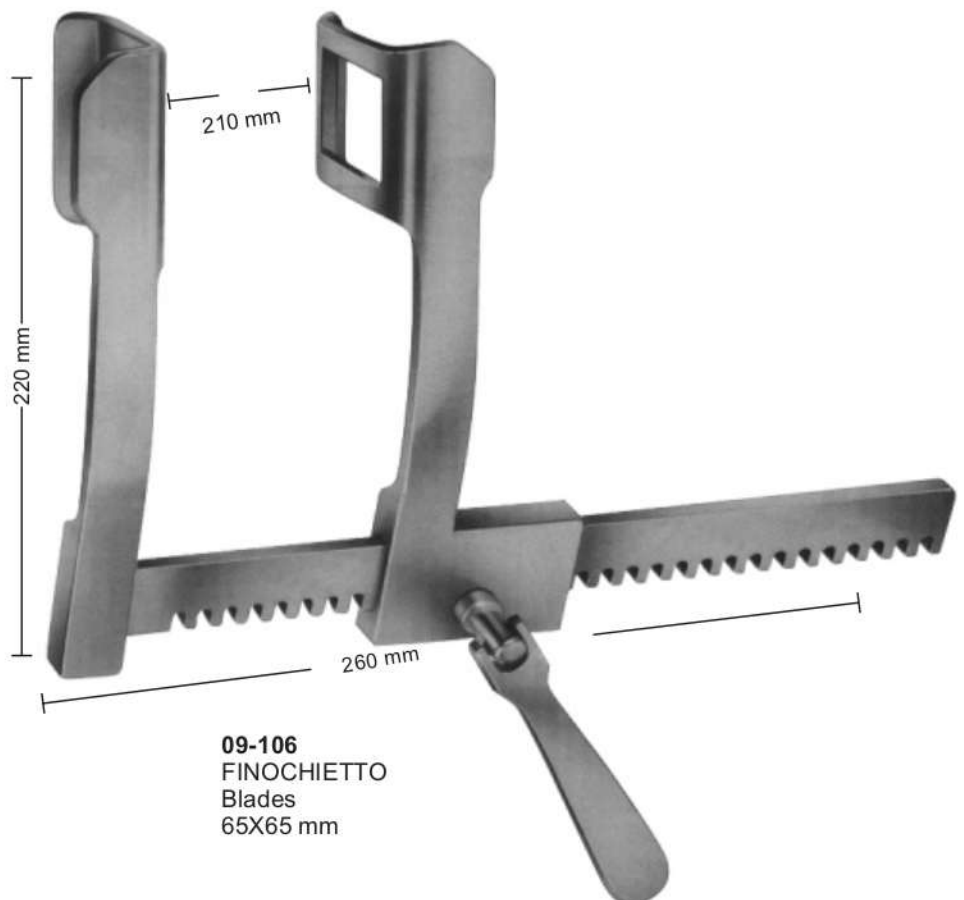

**09-106**  
FINOCHIETTO  
Blades  
65X65 mm



**09-108**  
 Blades  
 46x67 mm



**09-109**  
 Blades  
 80x67 mm



**09-110**  
 Blades  
 46x67 mm

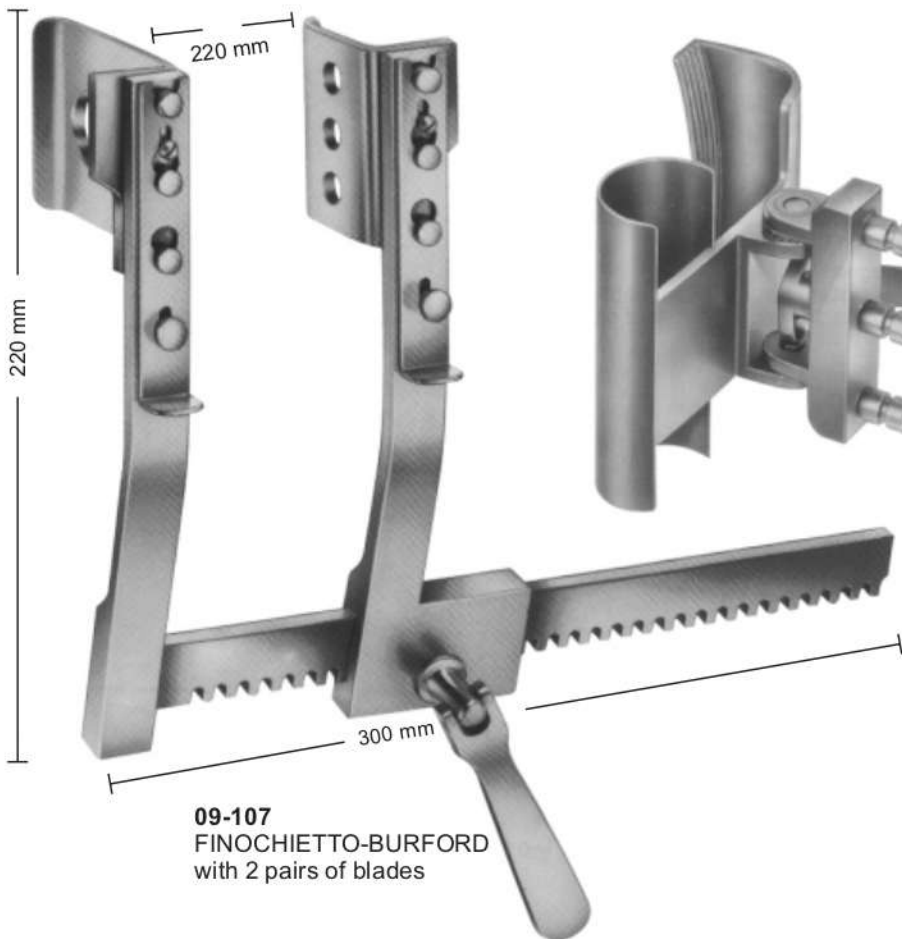

**09-107**  
**FINOCHIETTO-BURFORD**  
 with 2 pairs of blades

**09-111**  
 Blade, Only, for preparation  
 of a. Mammaria, 25.5x80mm



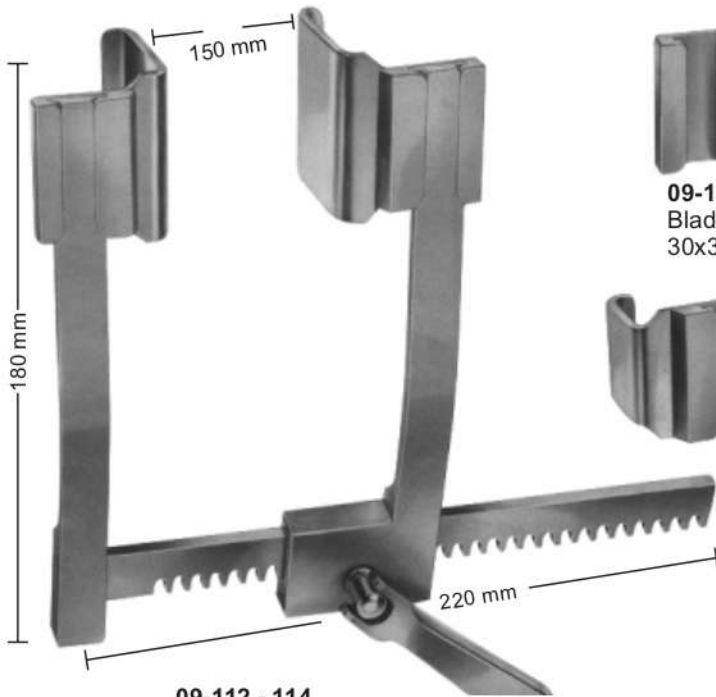
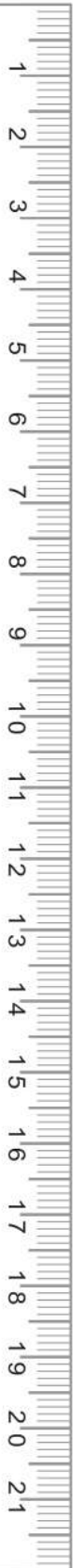

**09-112 - 114**  
DE-BAKEY  
with 3 pairs of blad

**09-112**  
Blades  
30x30 mm

**09-113**  
Blades  
40x40 mm

**09-114**  
Blades  
50x50 mm

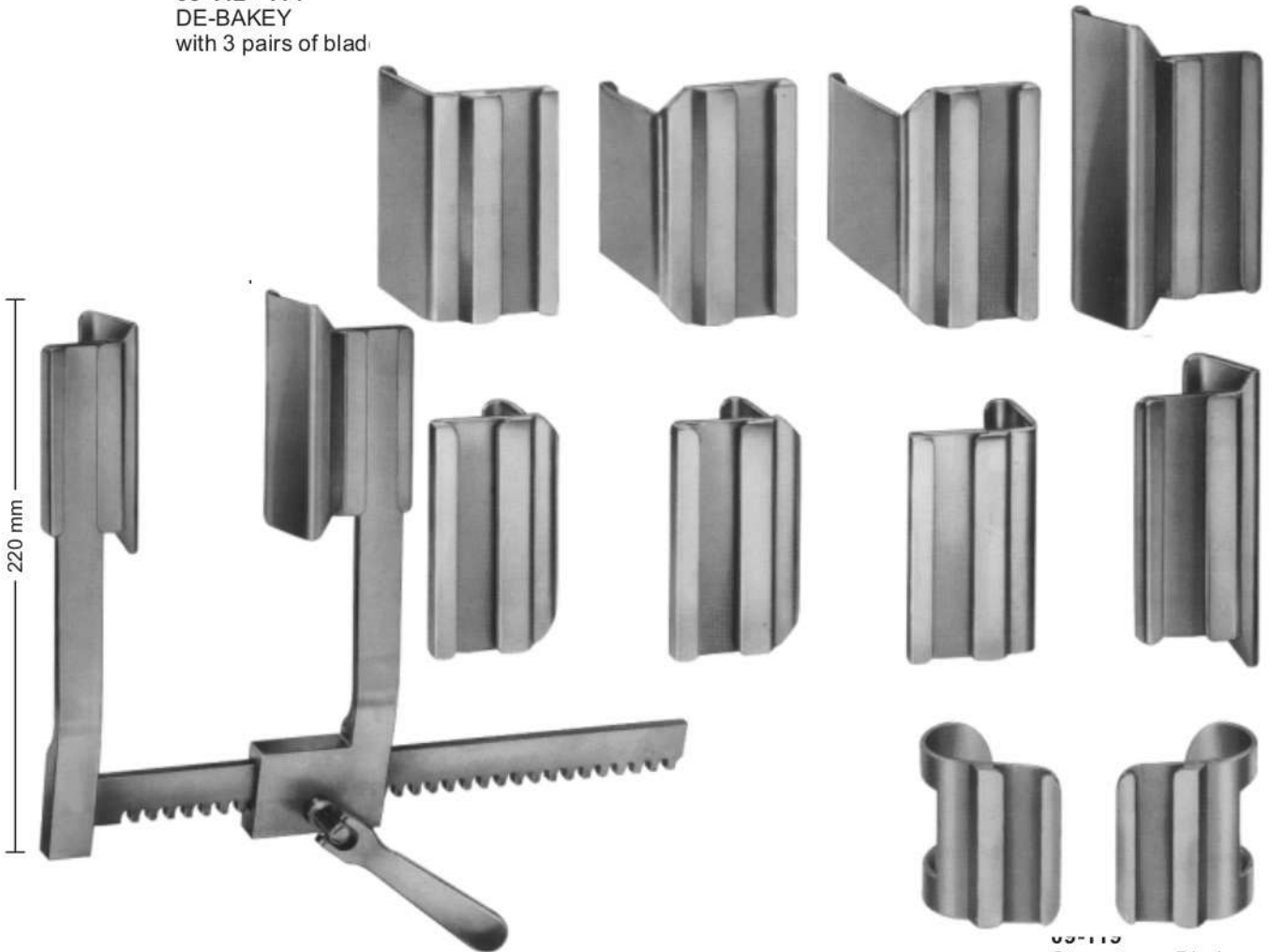

**09-115**  
Sternotomy Blades  
50x66 mm

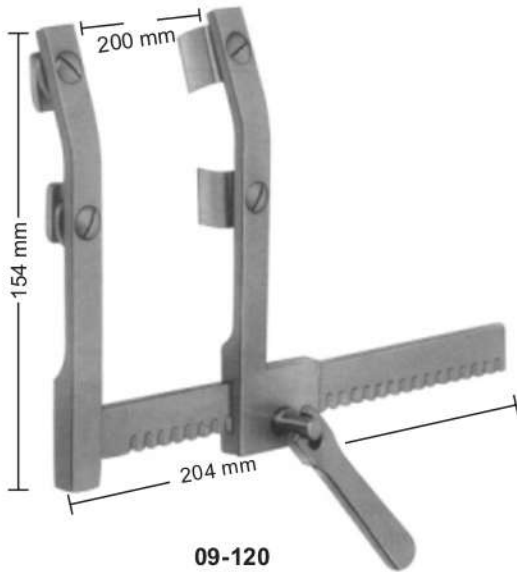

**09-120**  
**MORSE**  
Sternotomy spreader  
for children, with moveable  
double, each blade  
12x20 mm

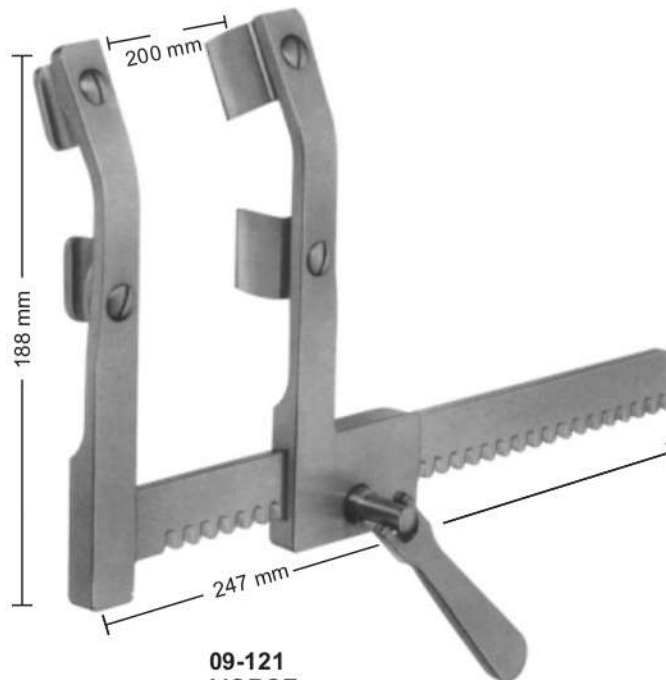

**09-121**  
**MORSE**  
Sternotomy spreader  
for adults, with moveable  
double, each blade  
19x19 mm



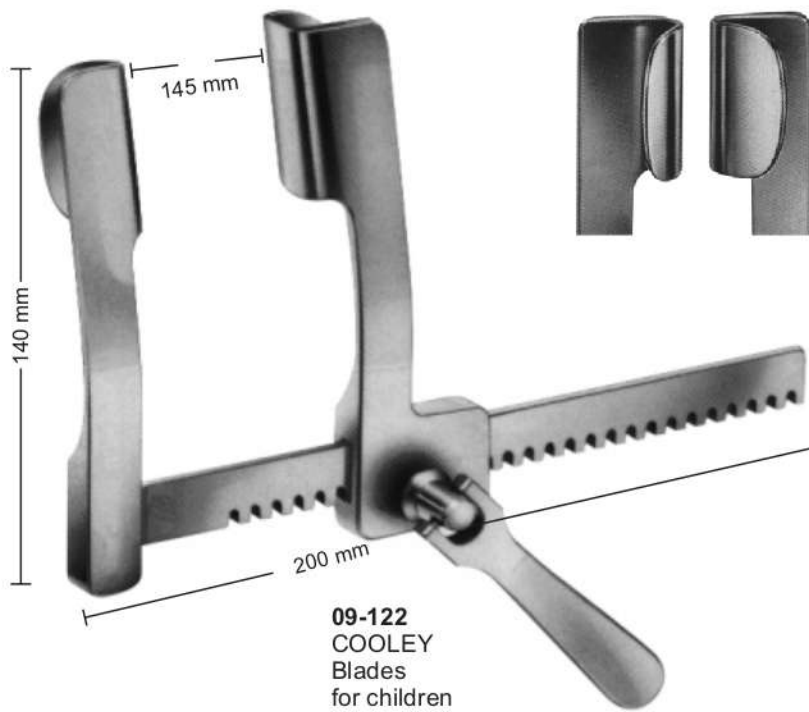
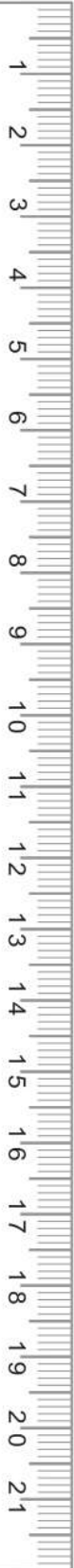

**09-122**  
COOLEY  
Blades  
for children  
21x45mm

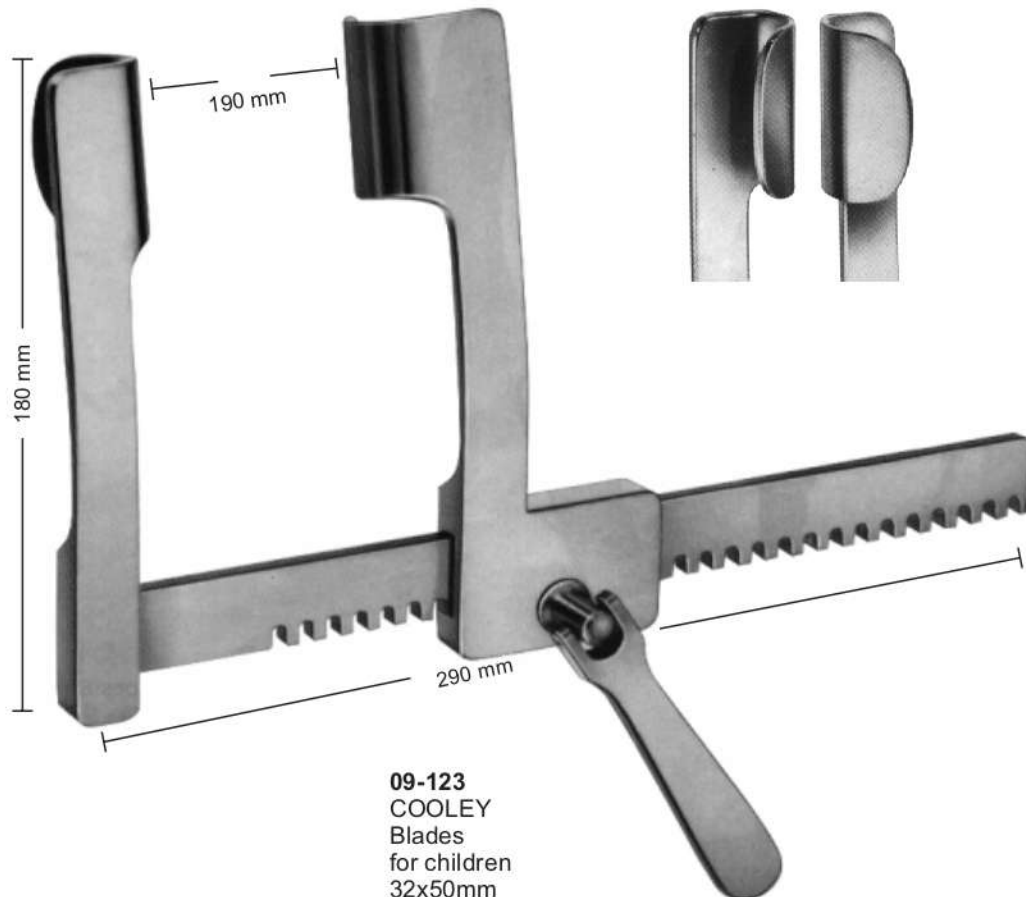

**09-123**  
COOLEY  
Blades  
for children  
32x50mm



**Thoracic Retractors**  
Thoracic Retraktoren  
Retradores Torácicos



**09-125**  
Blades  
75x75 mm



**09-126**  
Blades  
42x65 mm



Blades with Ball Snap System  
Delivery: in Pairs

- 09-124 - 126**  
Thoraxsperrer (Mercedes-Sperrer)  
complete consisting of:
- 09-124** Retractor only
  - 09-125** 1 Pair of blades 42x65 mm
  - 09-126** 1 Pair of blades 75x75 mm





**09-127**  
**SELLORS**  
 Rib spreader-and contractor  
 with swivel blades  
 200 mm



**09-128**  
**BAILEY**  
 150 mm



**09-129**  
 for children

**09-130**  
 for children

**09-129 - 130**  
**BAILEY**  
 200 mm

90° upwards cutting

85 mm

10-101  
4 mm



1/4

10-102  
5 mm



1/4

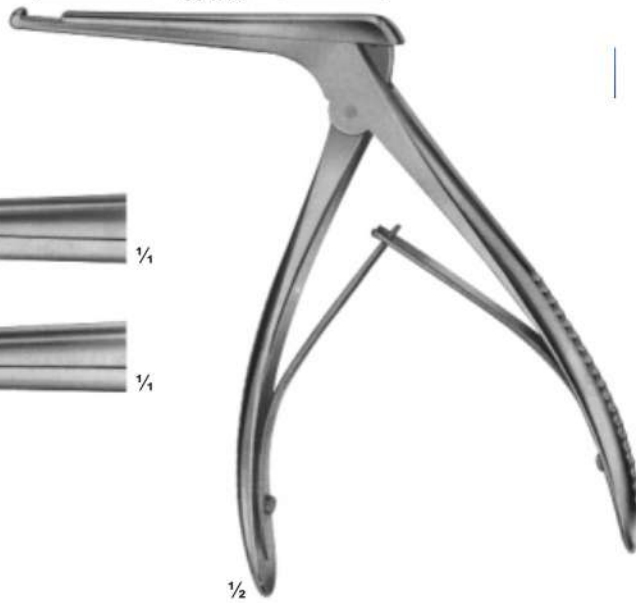

10-101 - 102  
KERRISON

90° upwards cutting

140 mm

10-103  
3,3 mm



1/4

10-104  
4,0 mm



1/4

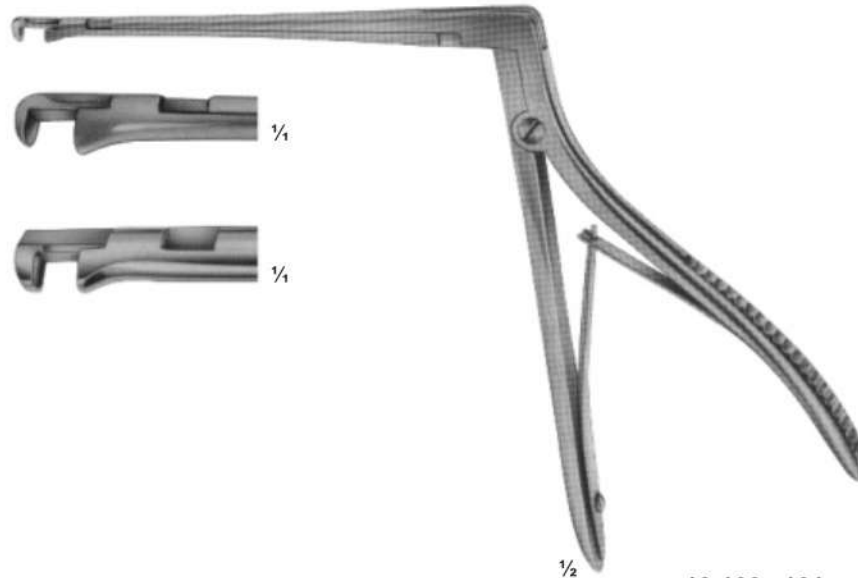

10-103 - 104  
HAJEK-KOFLER

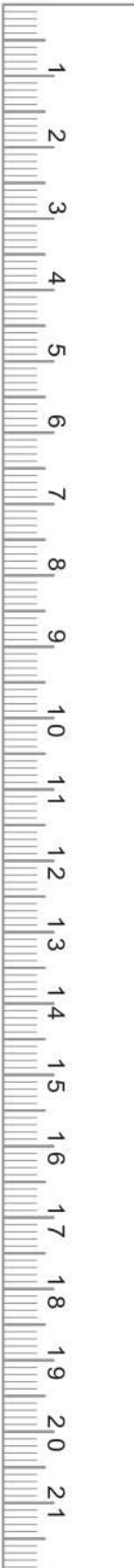



**130°** upwards cutting

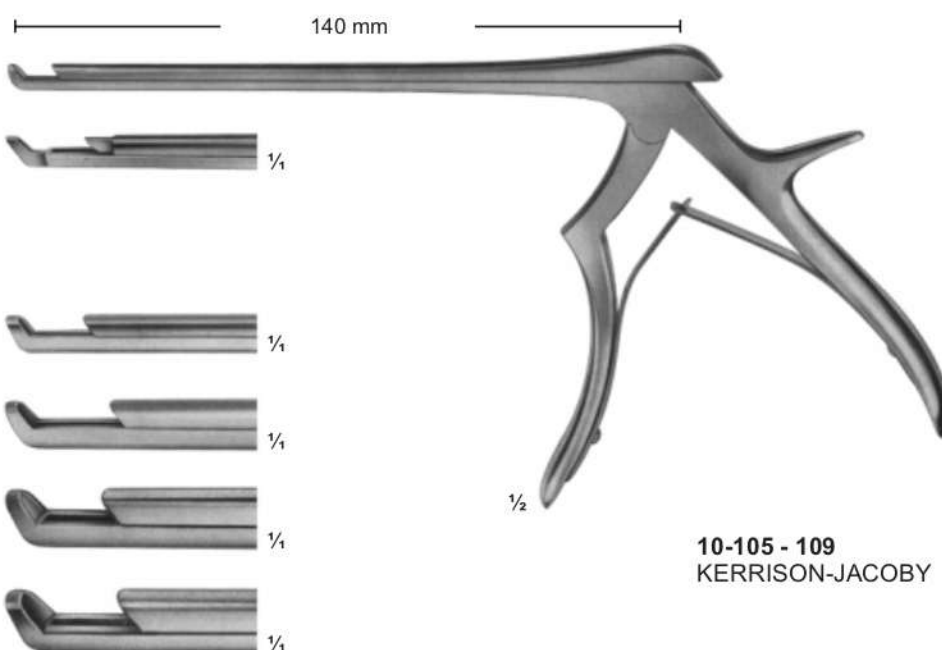

**90°** upwards cutting

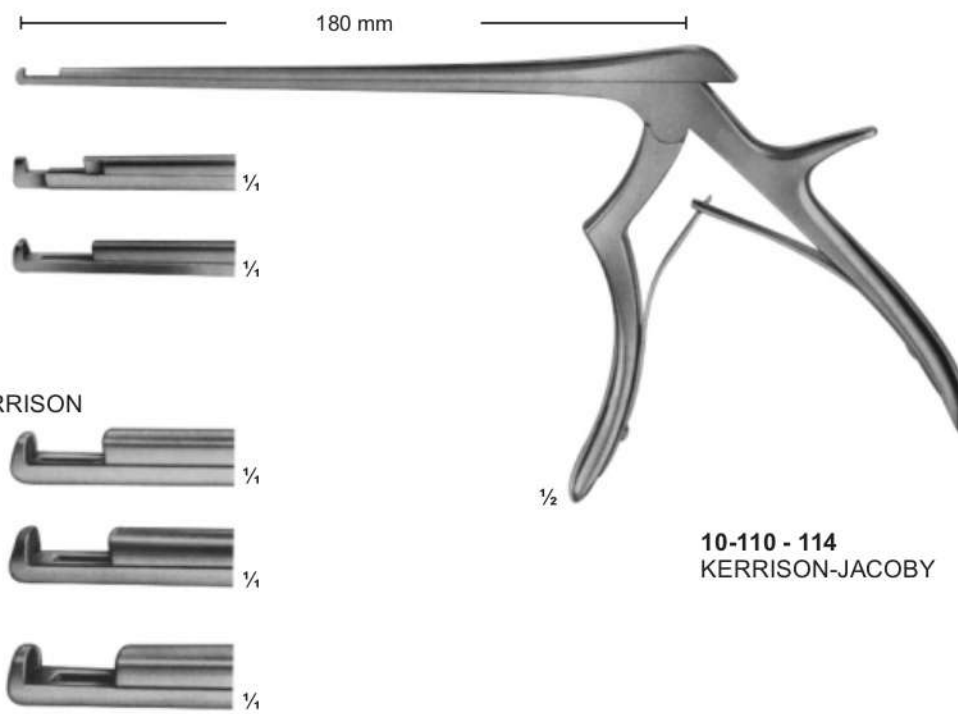

Angled positions for rongeurs

- 10-115  
3,0 mm
- 10-116  
3,6 mm
- 10-117  
4,2 mm
- 10-118  
4,8 mm
- 10-119  
5,8 mm

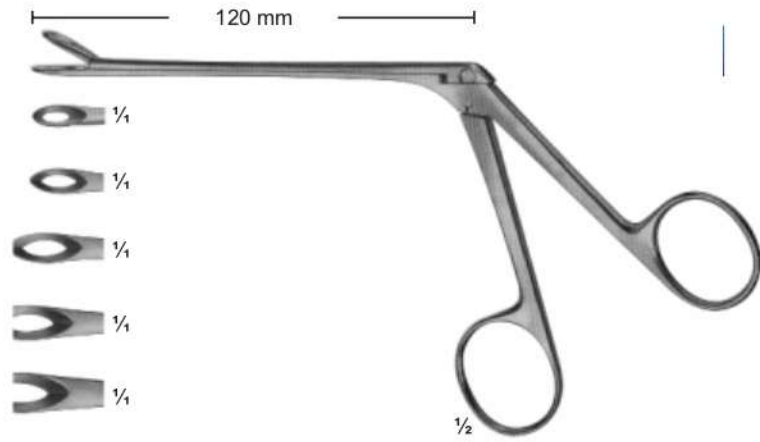

10-115 - 119  
WEIL-BLAKESLEY

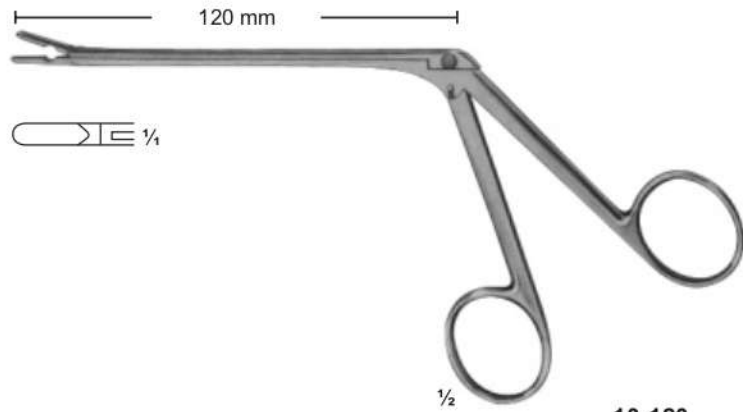

10-120  
TAKAHASHI  
3 mm

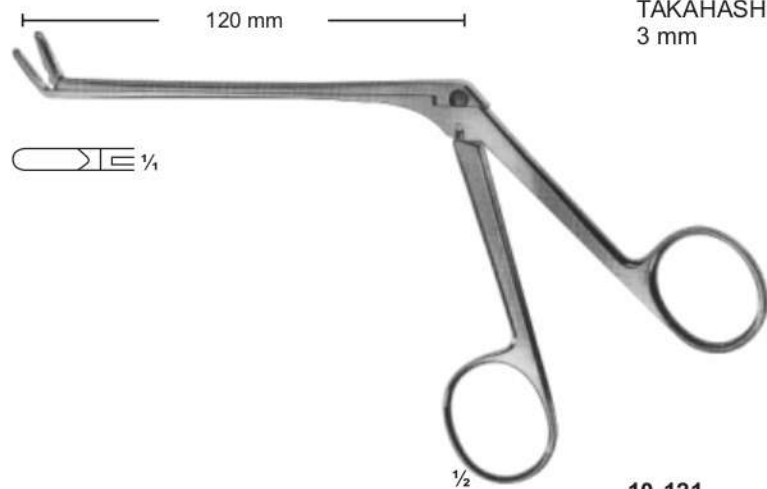

10-121  
TAKAHASHI  
3 mm

130°







**10-122**  
 2 X 10 mm

**10-123**  
 3 X 10 mm

**10-124**  
 4 X 10 mm

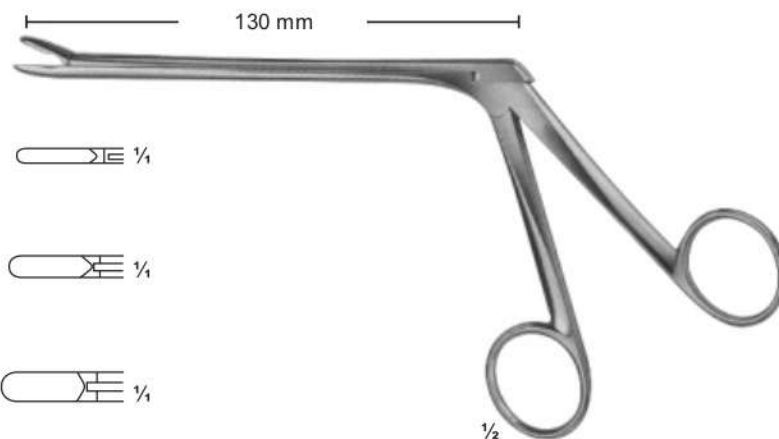

**10-122 - 124**  
**LOVE-GRUENWALD**

**10-125**  
 2 mm

**10-126**  
 3 mm

**10-127**  
 4 mm

**10-128**  
 5 mm

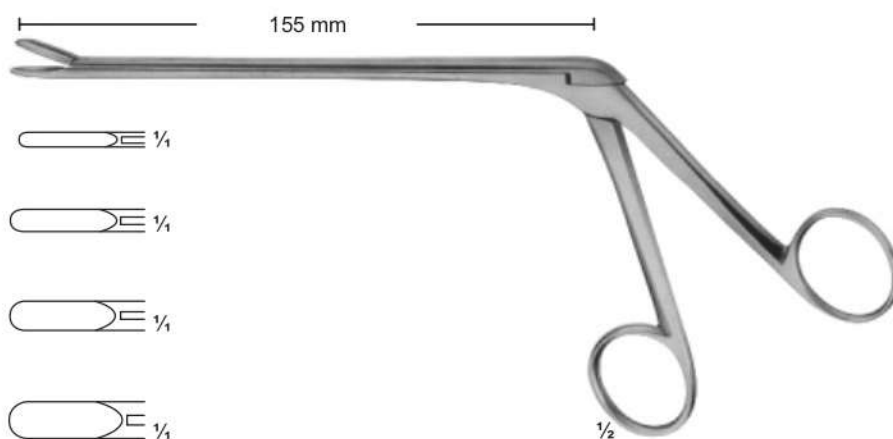

**10-125 - 128**  
**CASPAR**

**10-129**  
 2 mm

**10-130**  
 3 mm

**10-131**  
 4 mm

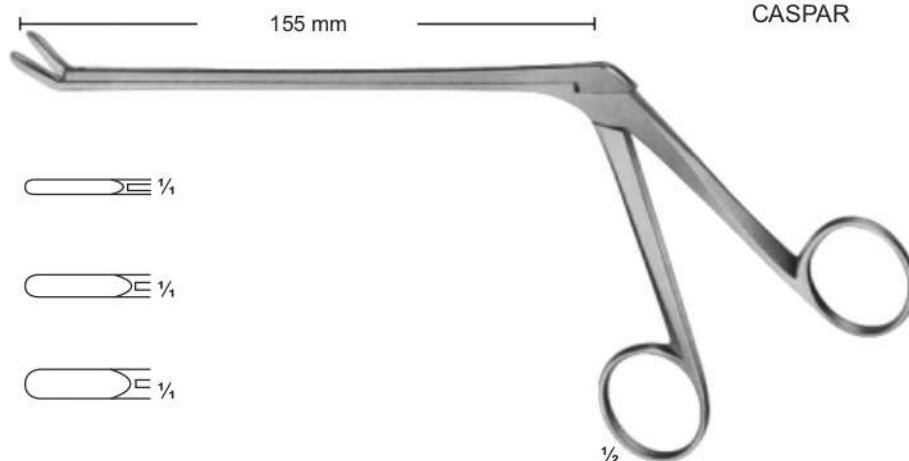

**10-129 - 131**  
**CASPAR**

Length of shaft 140 mm	Length of shaft 160 mm	Length of shaft size of jaws 185 mm		
<b>10-132</b>	<b>10-134</b>	<b>10-136</b>	3 X12 mm	1/4
<b>10-133</b>	<b>10-135</b>	<b>10-137</b>	4 X14 mm	1/4

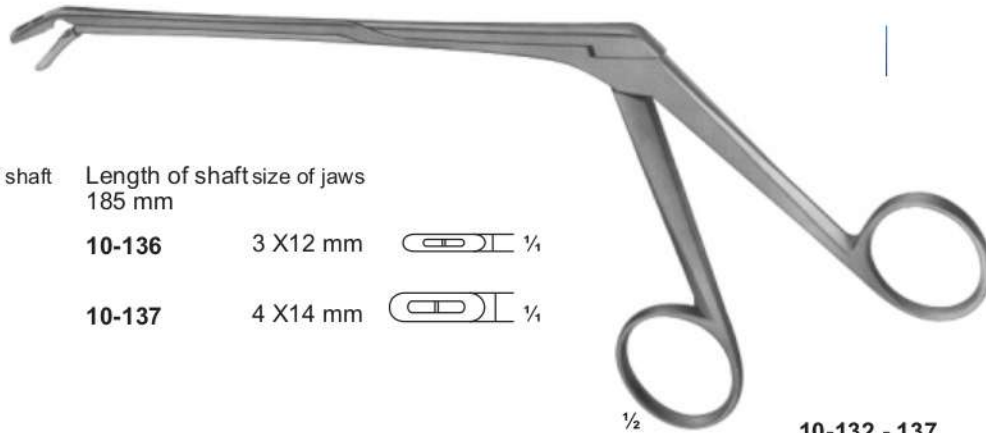

**10-132 - 137**  
GUSHING

**10-138**  
2 X 10 mm  
GUSHING



**10-139**  
3 X 10 mm  
LOVE-GRUENWALD

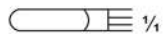

**10-140**  
4 X 10 mm  
SPURLING

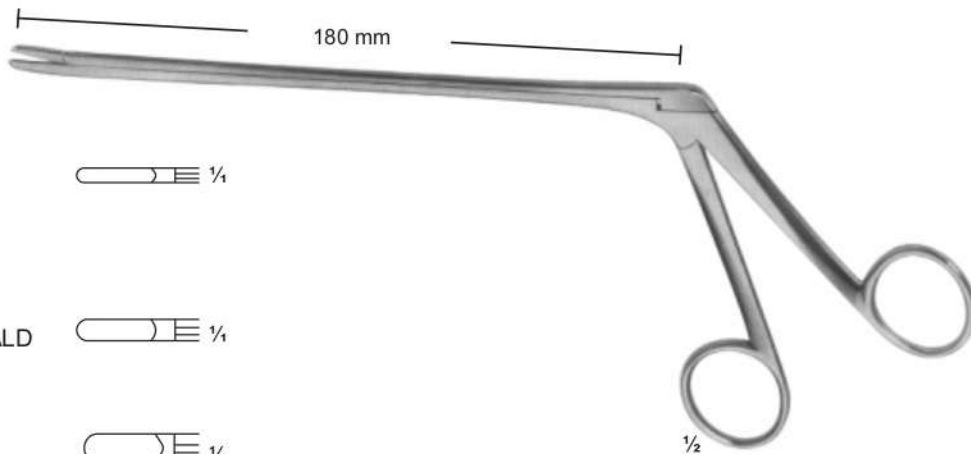
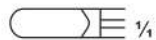

**10-138 - 140**  
LOVE-GRUENWALD

**10-141**  
3 X 10 mm  
LOVE-GRUENWALD



**10-142**  
4 X 10 mm  
SPURLING

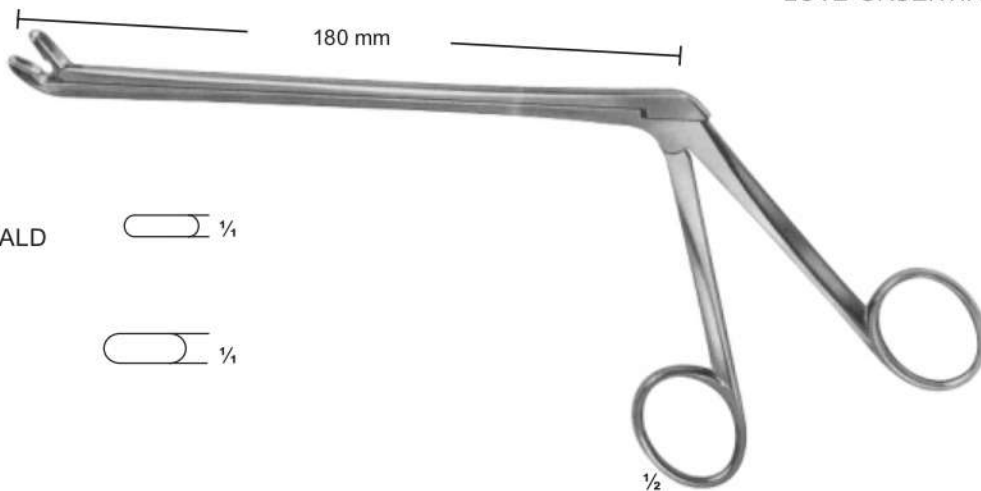

**10-141 - 142**  
LOVE-GRUENWALD

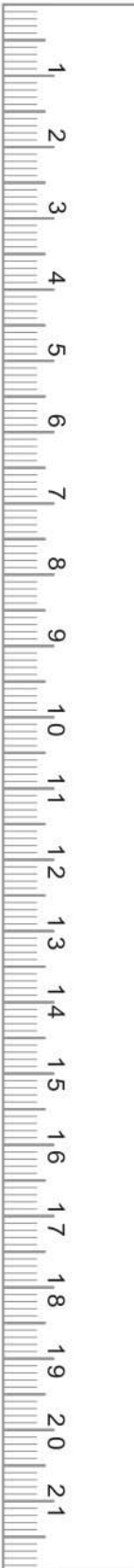

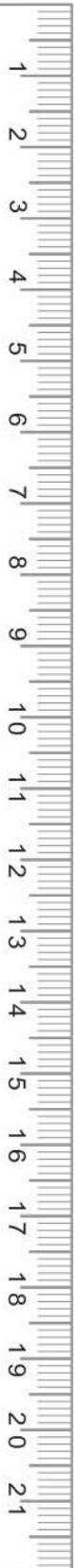

**10-143**  
3 X 10 mm  
LOVE-GRUENWALD



**10-144**  
4 X 10 mm  
SPURLING

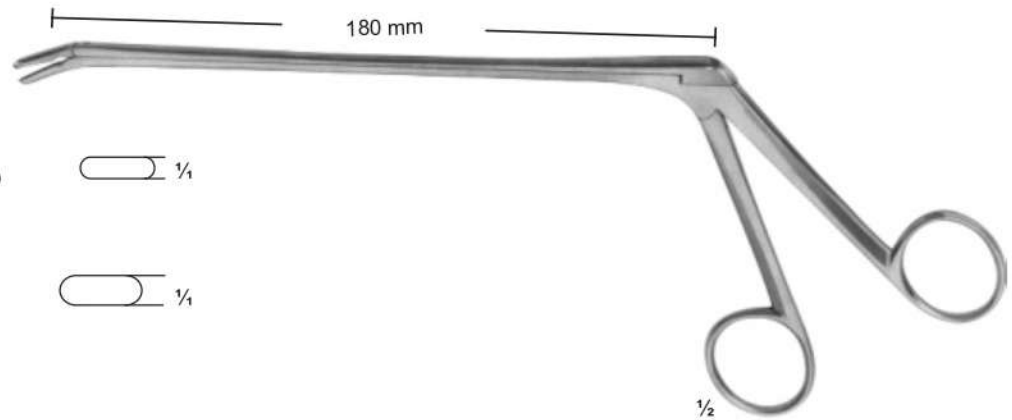

**10-143 - 144**  
LOVE-GRUENWALD

**10-145**  
7 mm

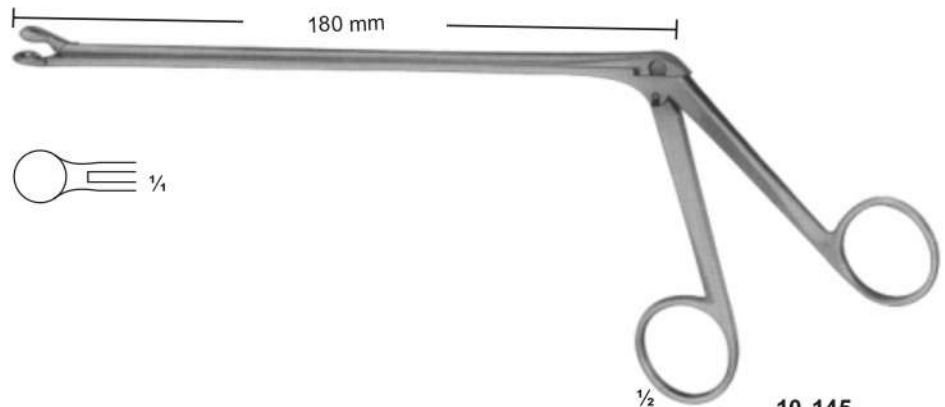
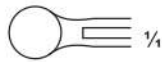

**10-145**  
OLDBERG

**10-146**  
YASARGIL  
2,2 mm



**10-147**  
YASARGIL  
3,5 mm

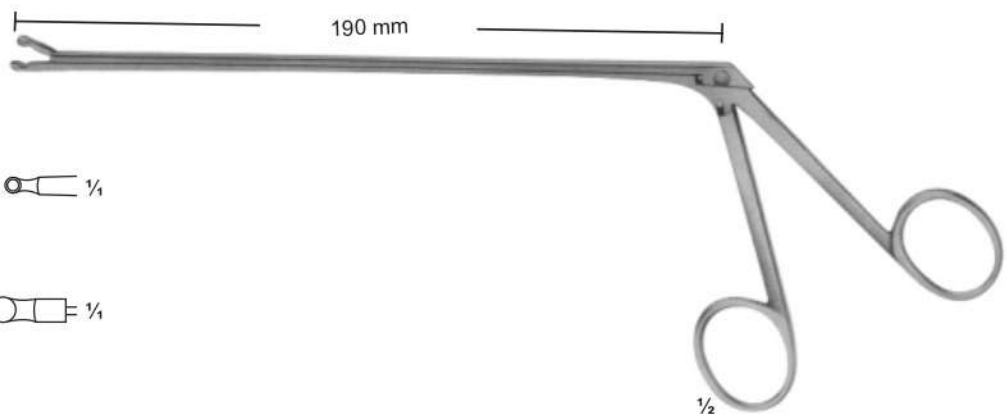

**10-146 - 147**

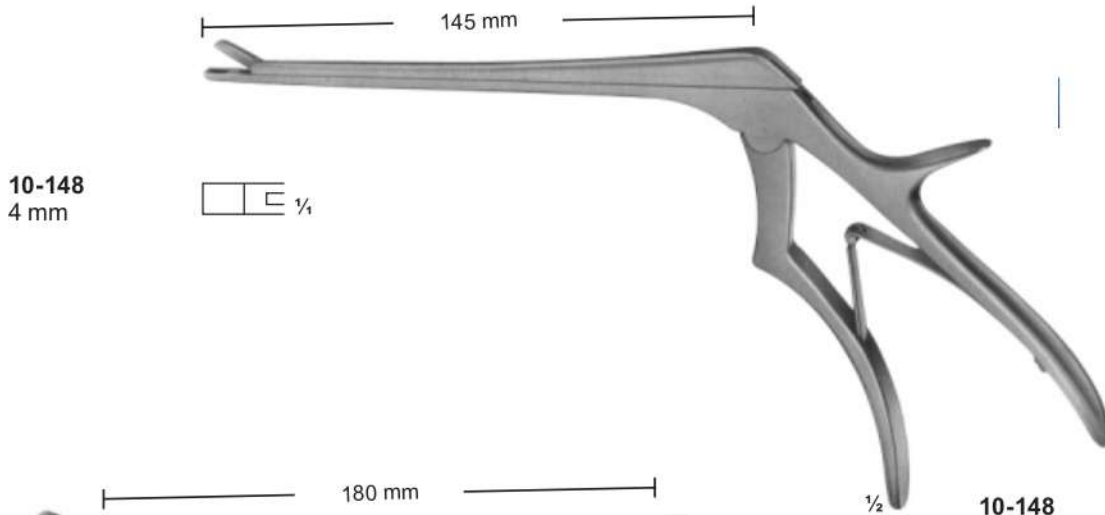

10-148  
CASPAR

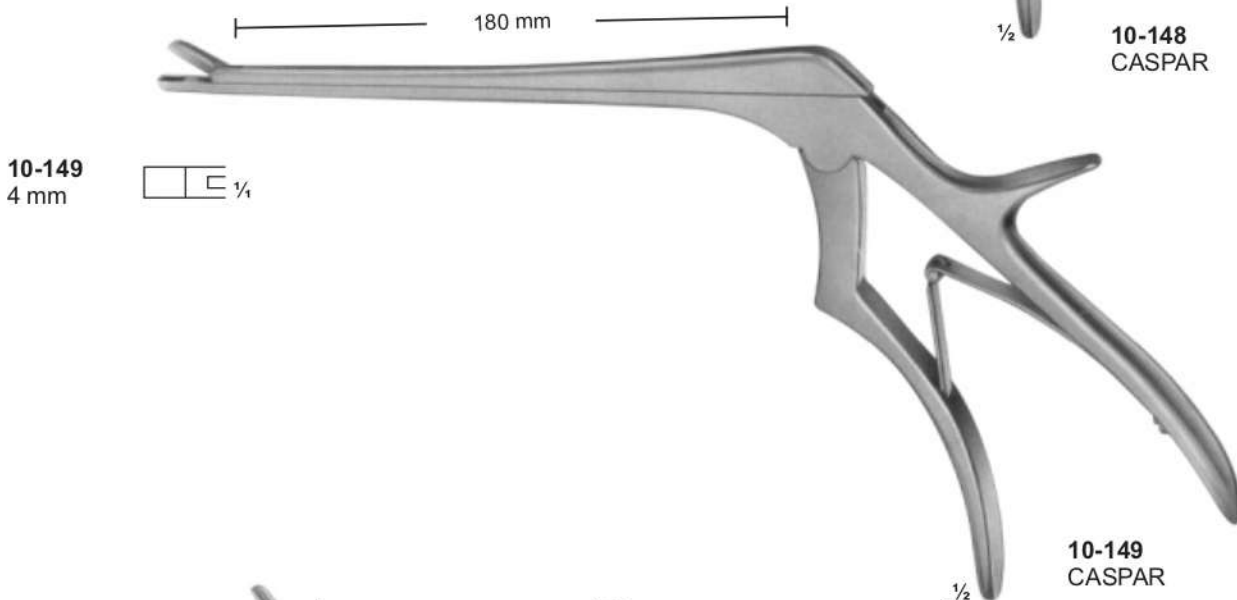

10-149  
CASPAR

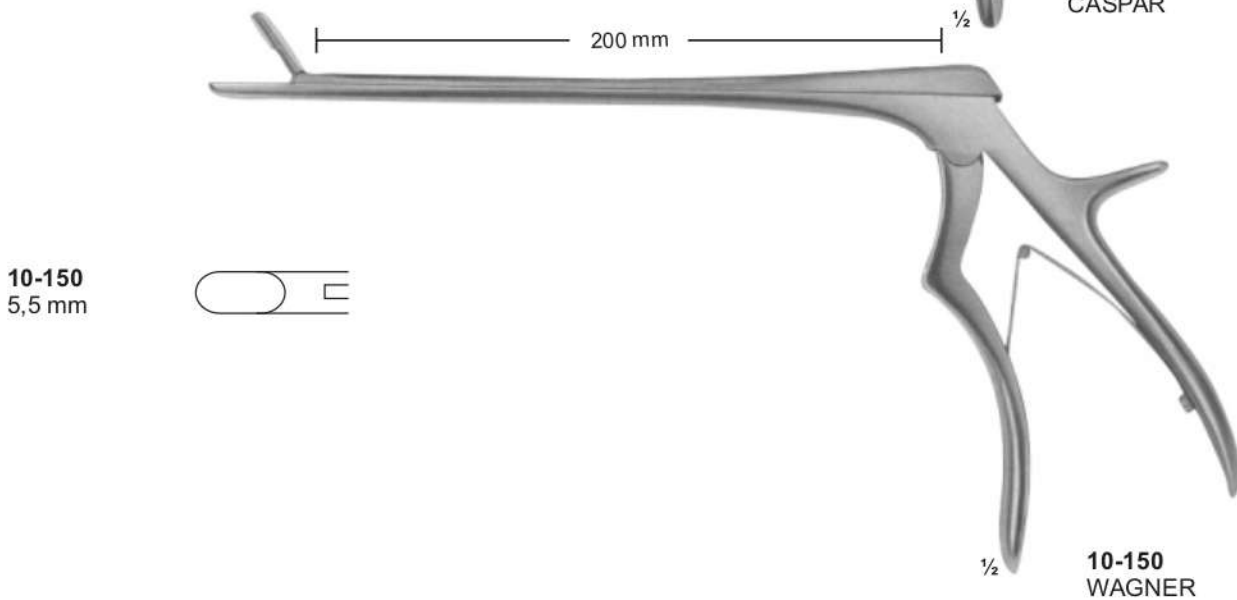

10-150  
WAGNER

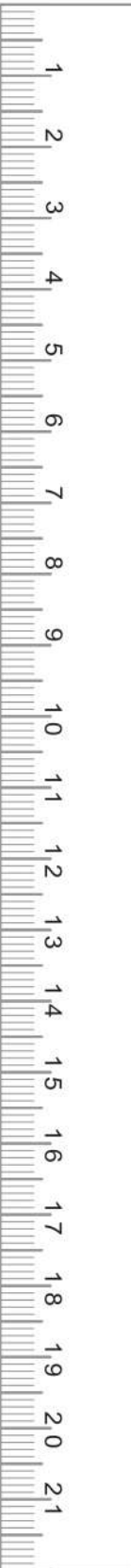

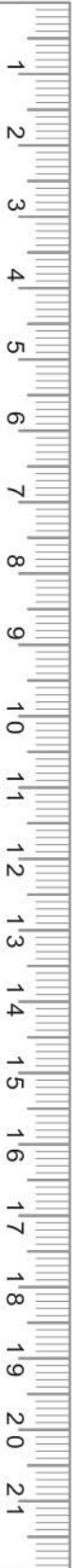

1/3

**10-151**  
CHARRIEER  
Length of blade  
215 mm  
complete with one saw  
blade each  
350 mm  
Spare saw blades, carbon steel  
**10-152** 12 mm  
**10-153** 20 mm

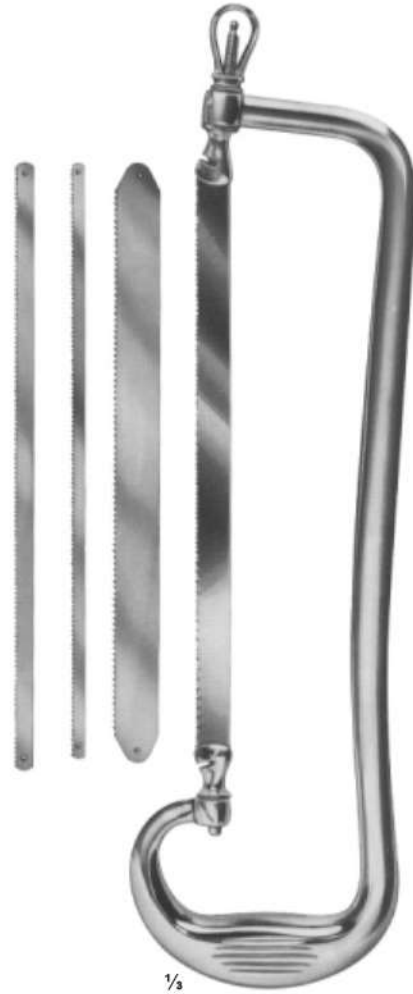

1/3

**10-154**  
RUST  
Length of blade  
235 mm  
complete with one saw  
blade each  
390 mm  
**10-155** Bow only  
Spare saw blades, carbon steel  
**10-156** 6 mm  
**10-157** 12 mm  
**10-158** 20 mm

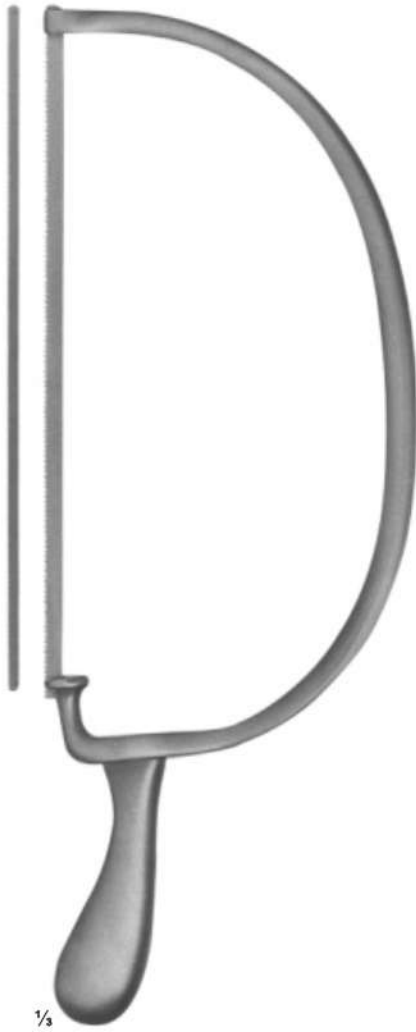

1/3

**10-159**  
 BIER  
 Length of blade  
 270 mm  
 complete with one saw  
 blade each  
 420 mm  
 Spare saw blades, carbon steel  
**10-160** 4 mm  
**10-161** 6 mm  
**10-162** 8 mm



1/3

**10-163**  
 CHARRIERE  
 Length of blade  
 180 mm  
 Spare saw blades,  
 carbon steel  
 270 mm  
**10-164**  
 CHARRIERE  
 Length of blade  
 240 mm  
 Spare saw blades,  
 carbon steel  
 340 mm



1/3

**10-165**  
 SATTERLEE  
 Length of blade  
 200 mm  
 Spare saw blades,  
 carbon steel  
 290 mm



1/3

**10-166**  
 LANGENBECK  
 Length of blade  
 115 mm  
 Metacarpal saw  
 235 mm

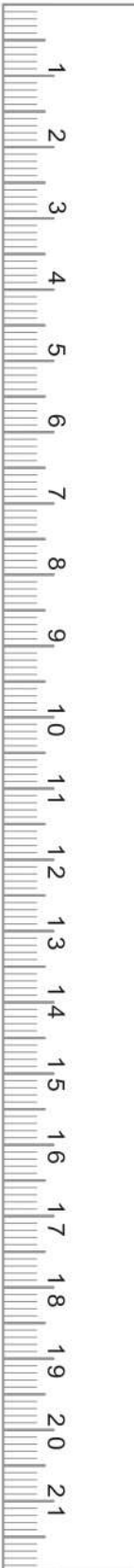

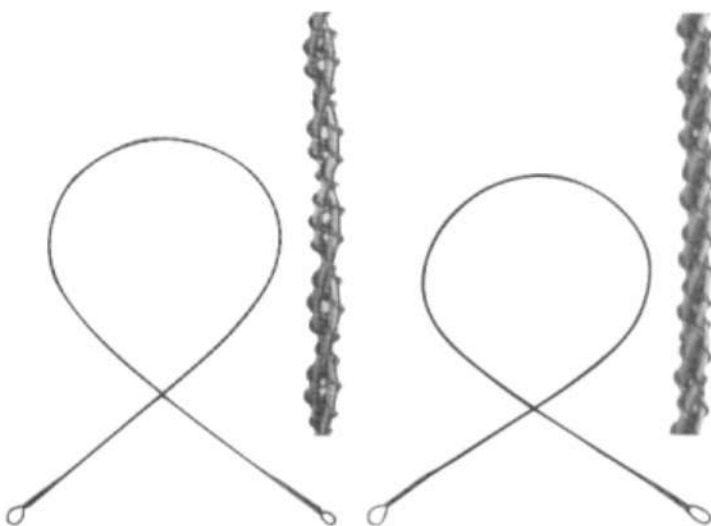

**OLIVECRONA**  
**10-167** 300 mm  
**10-168** 400 mm  
**10-169** 500 mm  
**10-170** 700 mm

**GIGLI**  
**10-171** 300 mm  
**10-172** 400 mm  
**10-173** 500 mm  
 fine, 6 wires twisted  
**10-174**  
 coares, 4 wires twisted



**10-175**  
**GIGLI**  
 Handle



**10-176**  
**LEBSCHE**  
 Conductor for  
 wire saws, malleable  
 250 mm

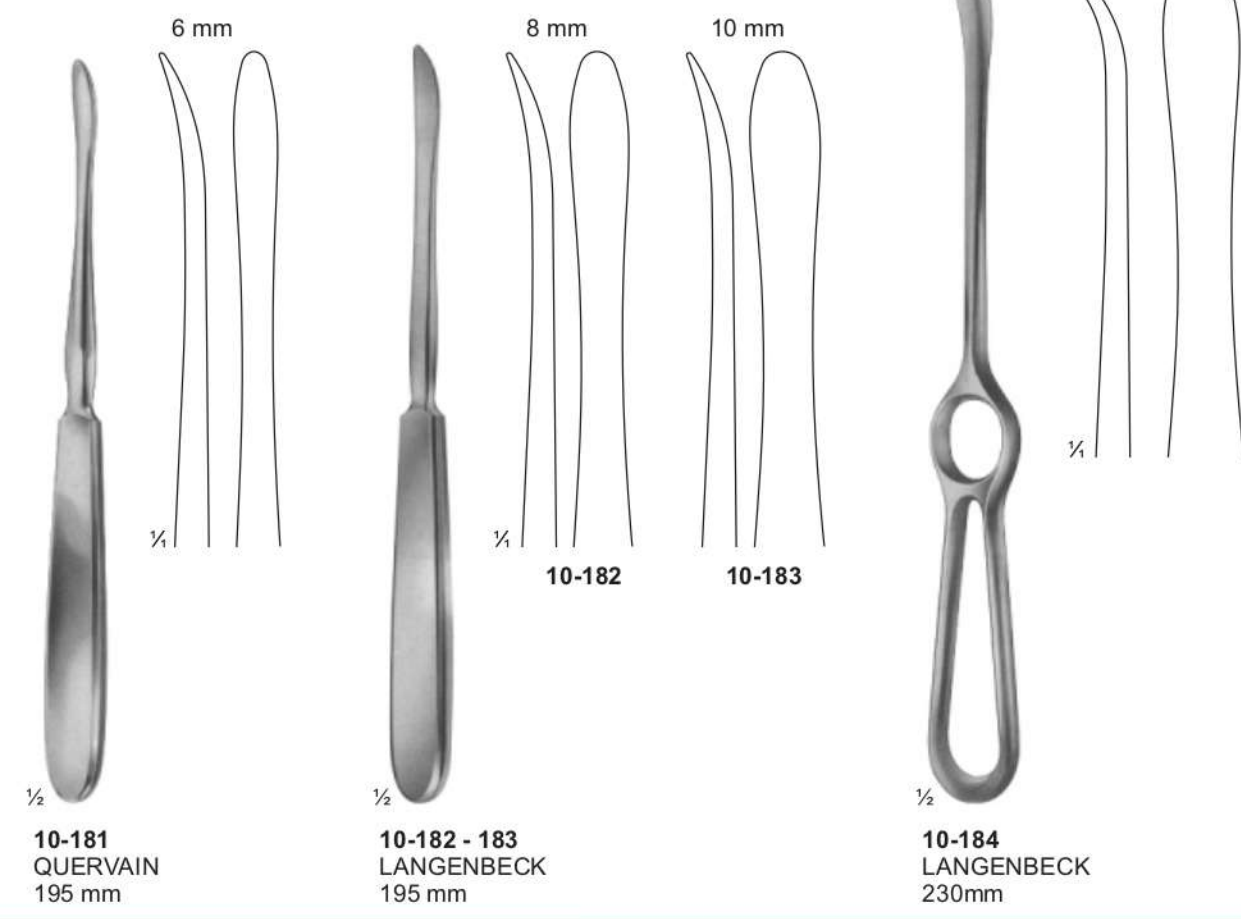
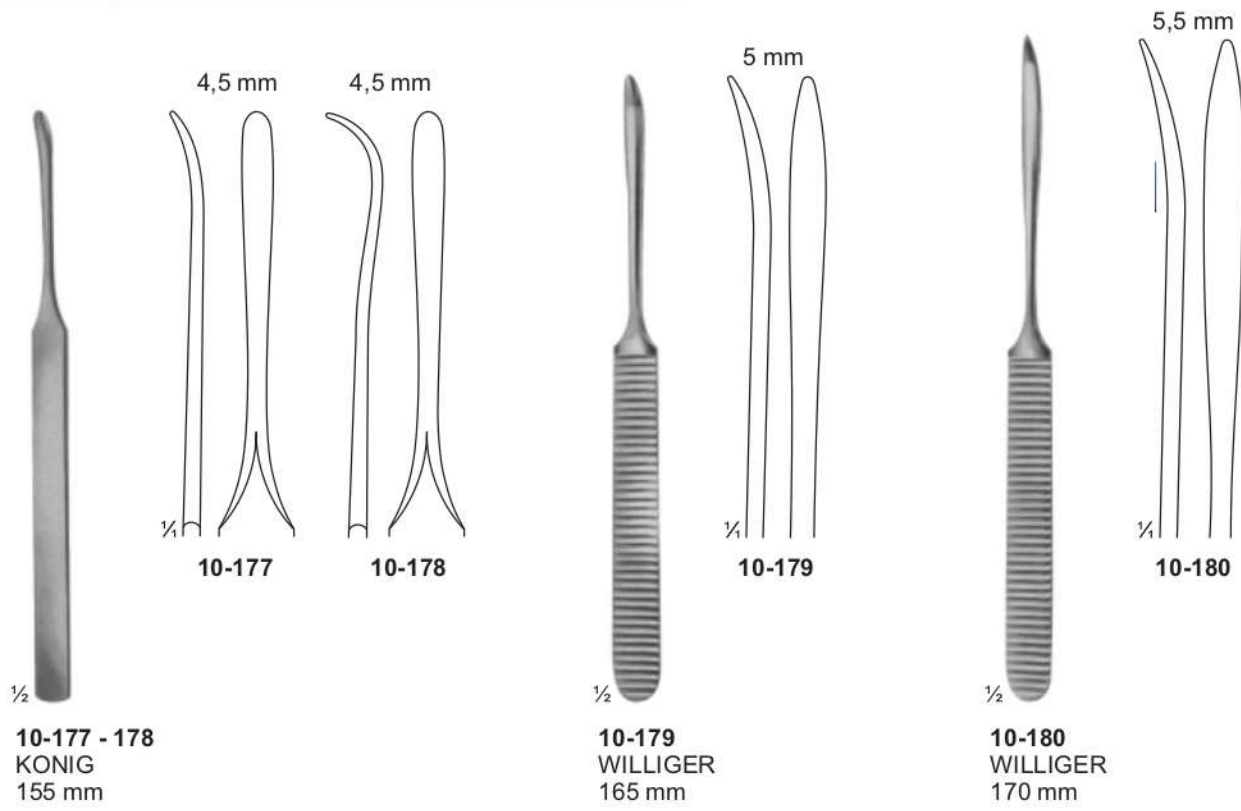





**10-185**  
LANE  
TRETHOWAN 215mm

**10-186**  
LANE  
255mm

**10-187**  
LANGE-HOHMANN  
250mm

**10-188 - 189**  
LANGE-HOHMANN  
**10-188** 265mm  
**10-189** 280mm



**Bone Levers**  
Knochen-hebel  
Las Palancas De Hueso

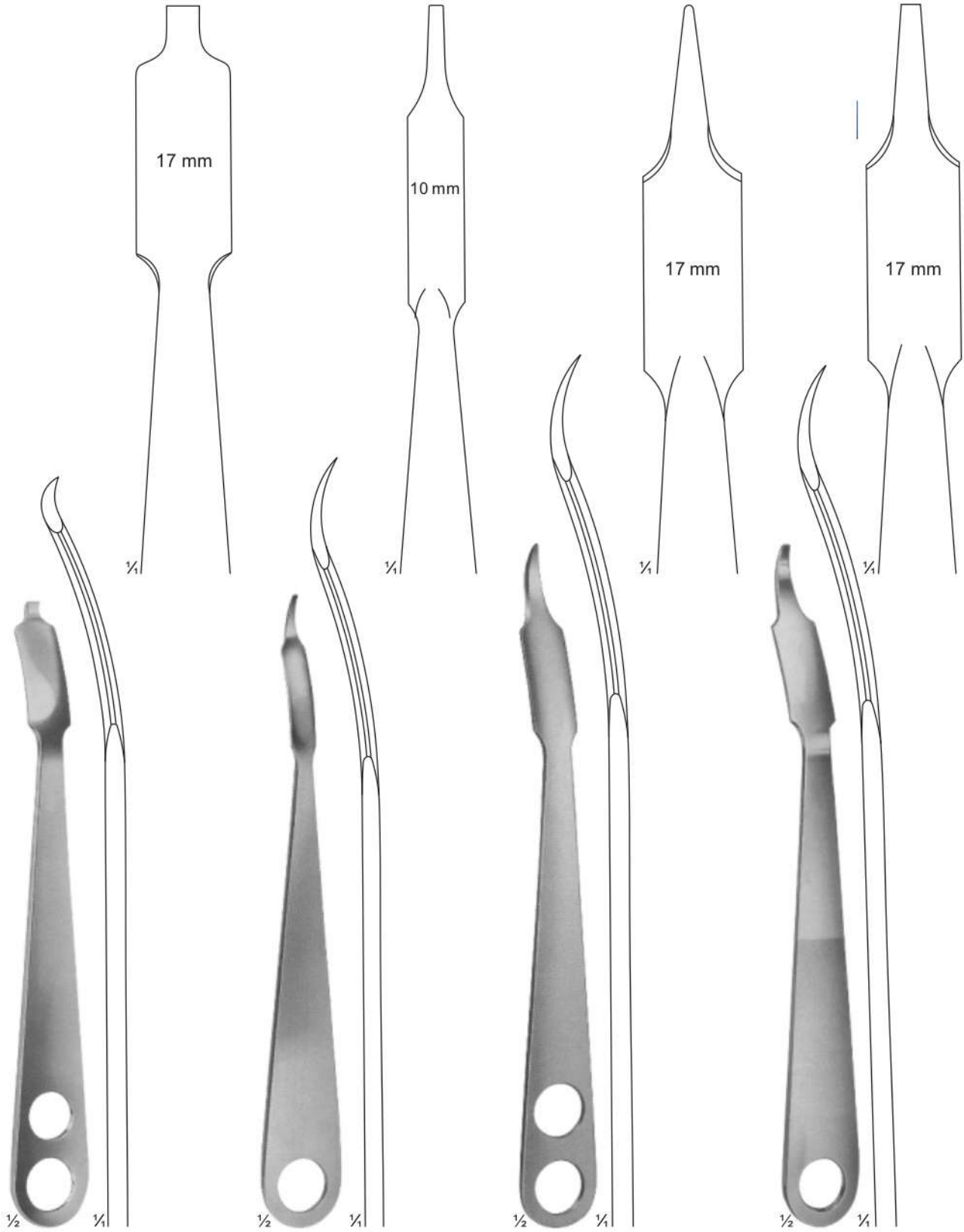

**10-190**  
WAGNER  
220 mm

**10-191**  
220 mm

**10-192**  
240 mm

**10-193**  
240 mm

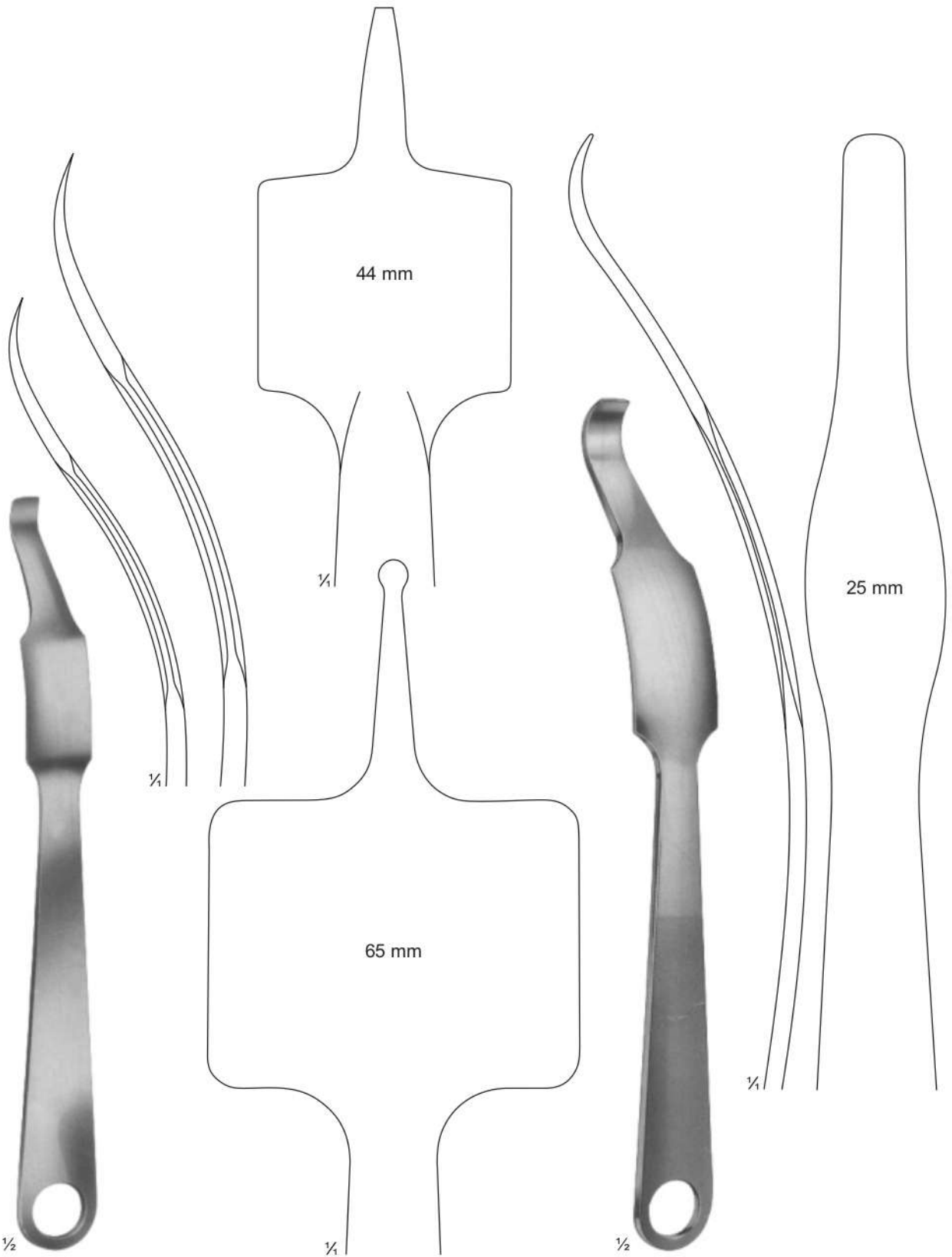

**10-194 - 195**  
VERBRUGGE-MULLER  
10-194 240 mm  
10-195 255 mm

**10-196**  
260 mm



**Bone Levers**  
Knochen-hebel  
Las Palancas De Hueso

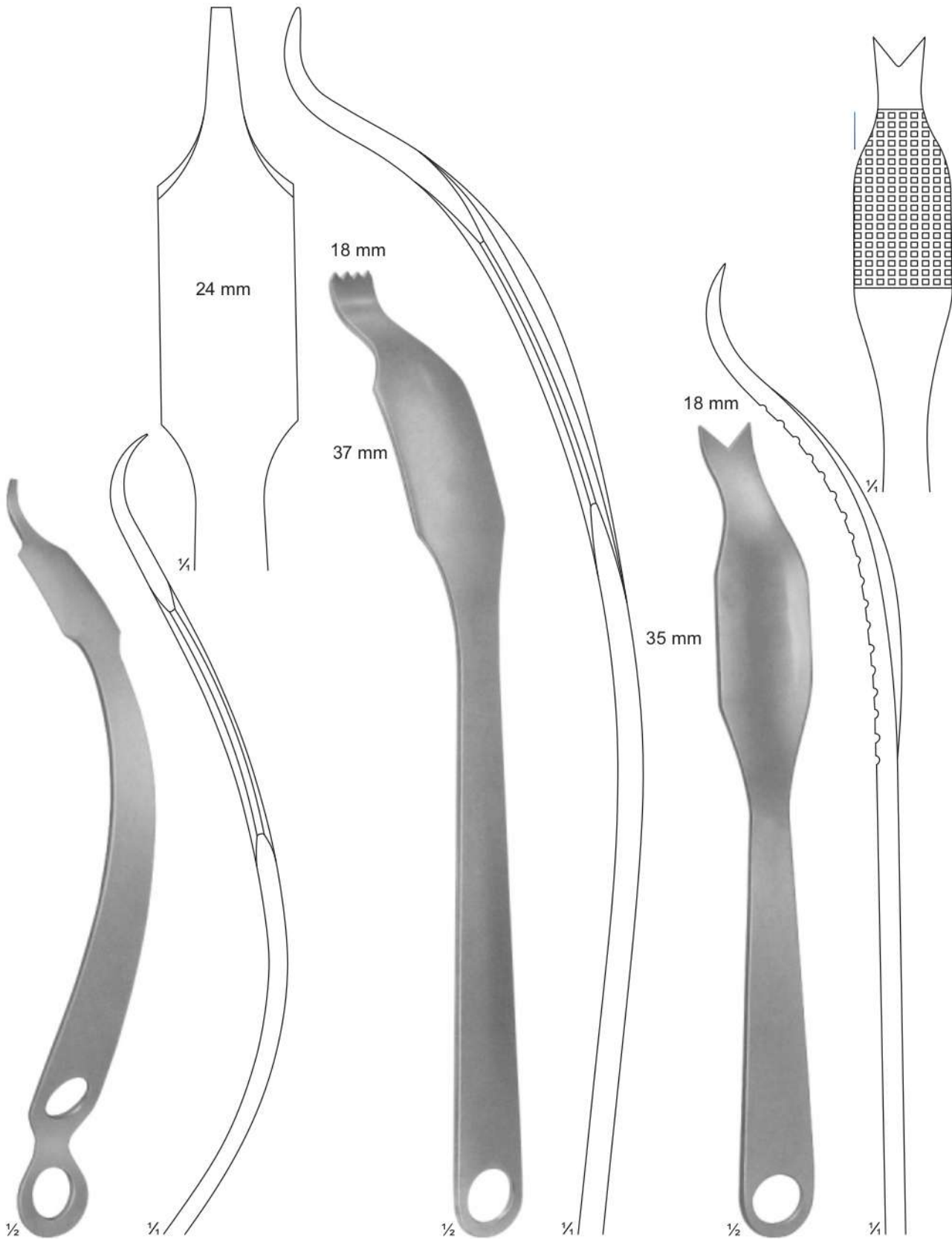

**10-197**  
HOHMANN-ALDINGER  
270 mm

**10-198**  
SCHUMACHER mod. WAGNER  
345 mm

**10-199**  
SCHUMACHER  
290 mm



**10-200 - 201  
PARTSCH  
150 mm**

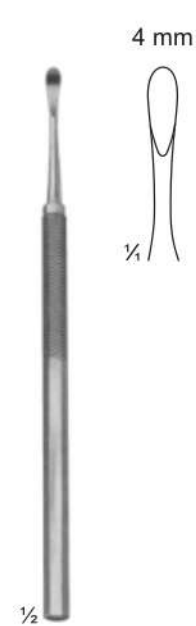

**10-202  
PARTSCH mod. LANGE  
145 mm**

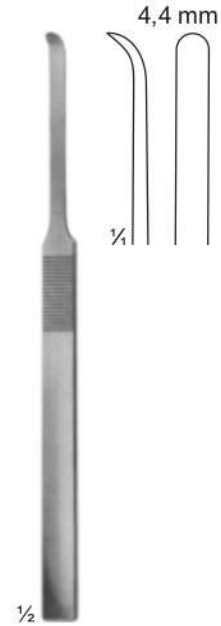

**10-203  
MC KENTY  
155 mm**

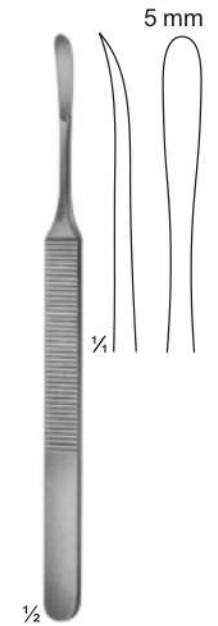

**10-204  
KONIG  
155 mm**

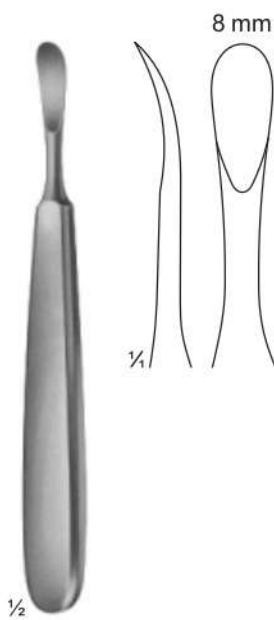

**10-205  
TRELAT  
150 mm**

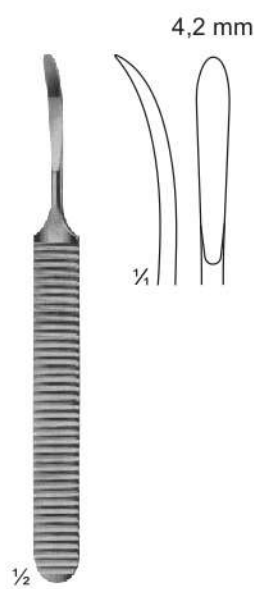

**10-206  
WILLIGER  
140 mm**

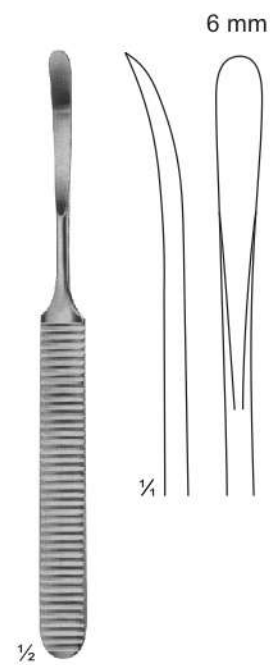

**10-207  
WILLIGER  
160 mm**

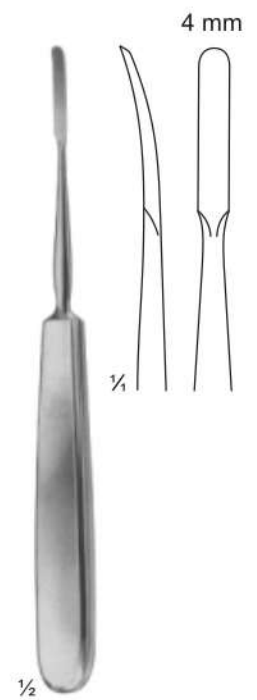

**10-208  
JOSEPH  
170 mm**



Raspatories  
Raspatories  
Raspatories

3,3 mm



1/2  
**10-209**  
HALLE  
stumpf/blunt  
180 mm

4 mm

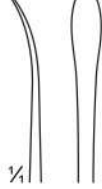

1/2  
**10-210**  
FREER  
stumpf/blunt  
190 mm

4 mm



1/2  
**10-211**  
FREER  
stumpf/sharp  
190 mm

5,9 mm

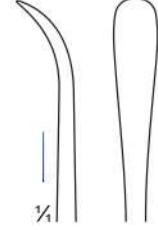

1/2  
**10-212**  
SEWALL  
stumpf/blunt  
190 mm

2,5 mm



**10-213**

3,5 mm



**10-214**

4,5 mm



**10-215**

5,0mm



**10-216**

8,0mm



**10-217**



1/2  
**10-213 - 215**  
PAULSEN  
205 mm



1/2  
**10-216 - 217**  
PAULSEN  
205 mm



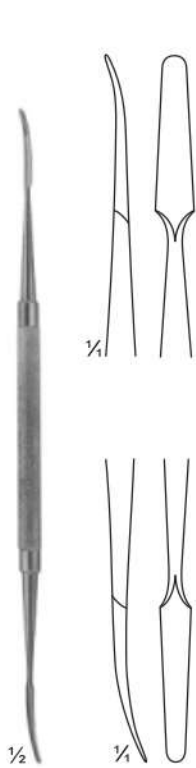

**10-218**  
KILLIAN  
sharp/blunt  
185 mm

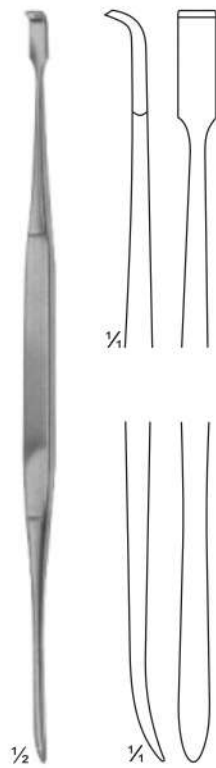

**10-219**  
HOWARTH  
sharp/blunt  
215 mm

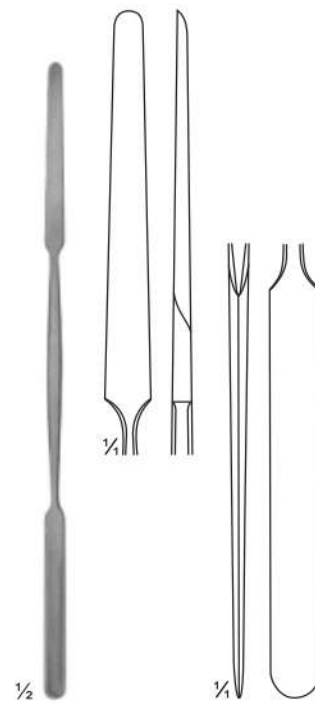

**10-220**  
KILLIAN  
sharp/blunt  
185 mm

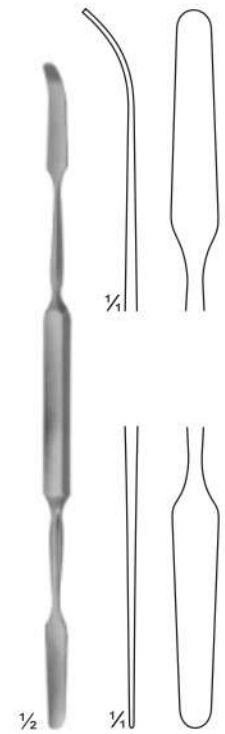

**10-221**  
MAC DONALD  
blunt/blunt  
185 mm

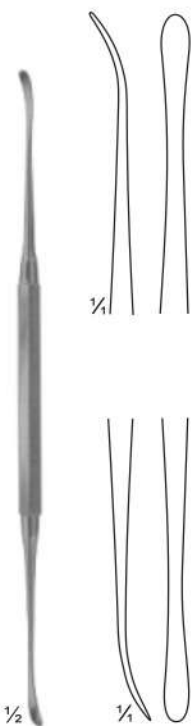

**10-222**  
FREER  
sharp/blunt  
185 mm

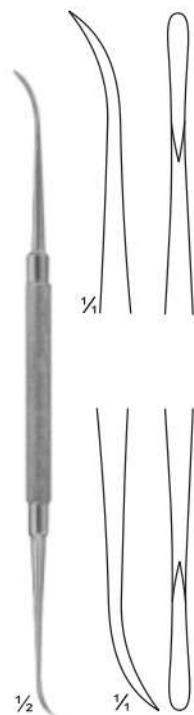

**10-223**  
FREER-YASARGIL  
sharp/sharp  
185 mm

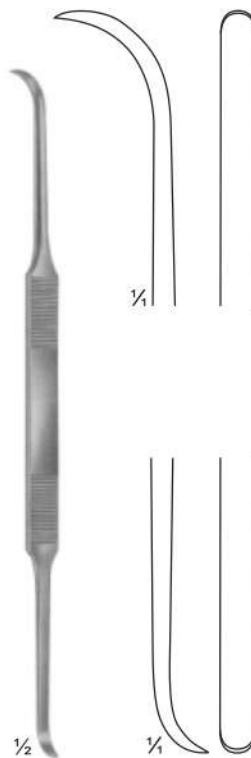

**10-224**  
COTTLE  
sharp/sharp  
200 mm

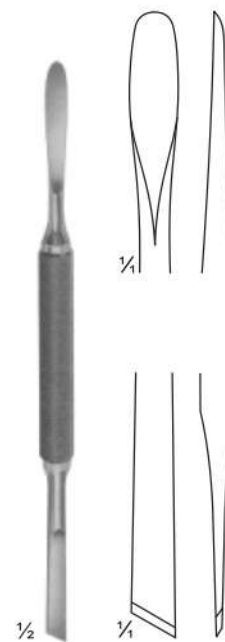

**10-225**  
MEAD  
sharp/sharp  
165 mm

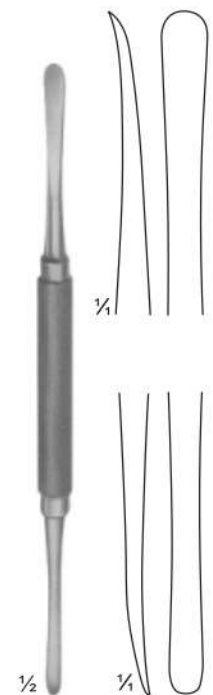

**10-226**  
MOLT  
sharp/sharp  
180 mm

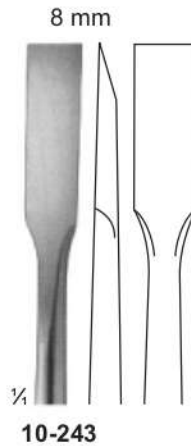
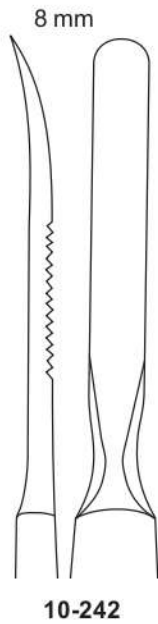
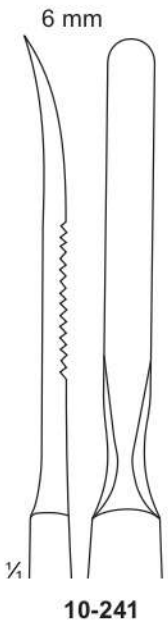
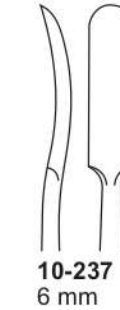
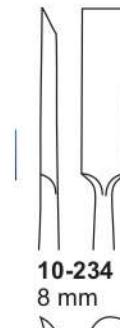
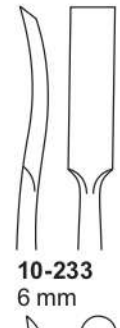
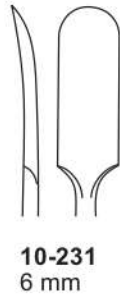
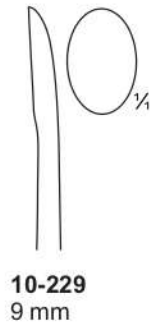
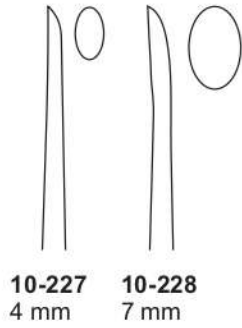



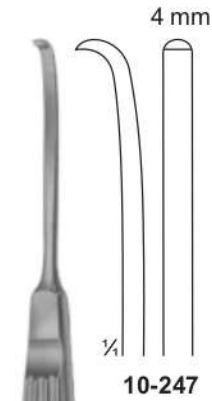

4 mm

10-247

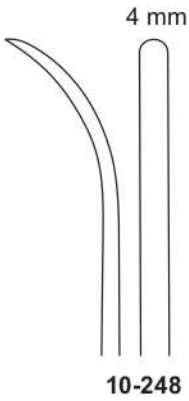

4 mm

10-248

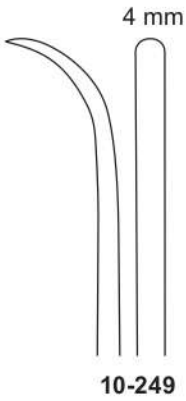

4 mm

10-249

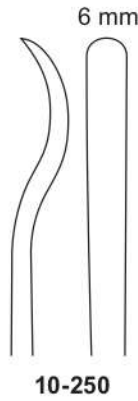

6 mm

10-250



10-247 - 250  
MUHLING  
170 mm



10-251  
COTTLE  
175 mm

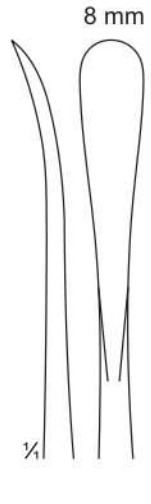

8 mm

1/4

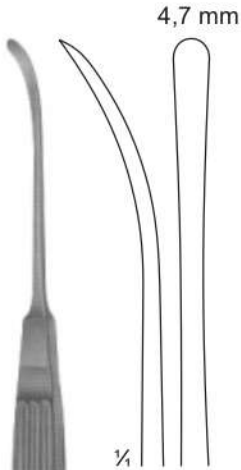

4,7 mm

1/4

10-252  
LANDOT  
175 mm

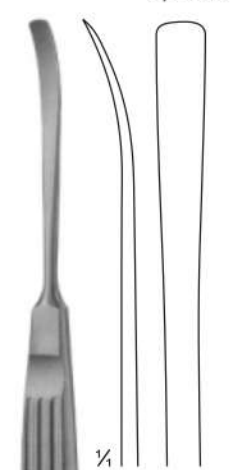

6,2 mm

1/4

10-253  
CASPER  
180 mm

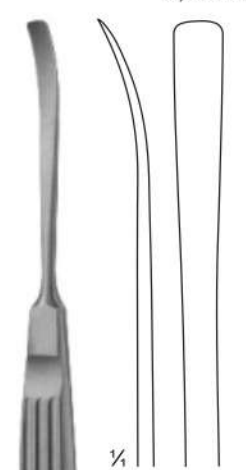

6,2 mm

1/4

10-254  
CASPER  
180 mm

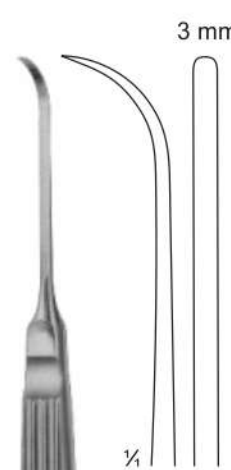

3 mm

1/4

10-255

10-255 - 256  
170 mm

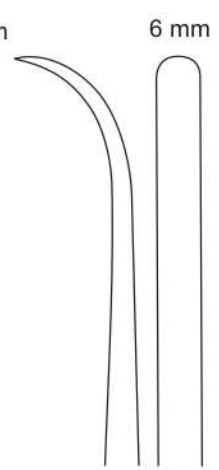

6 mm

10-256

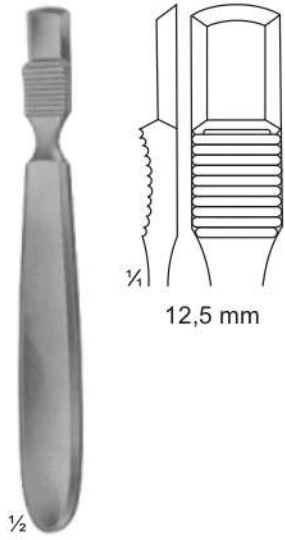

12,5 mm

**10-257**  
FARABEU  
140 mm

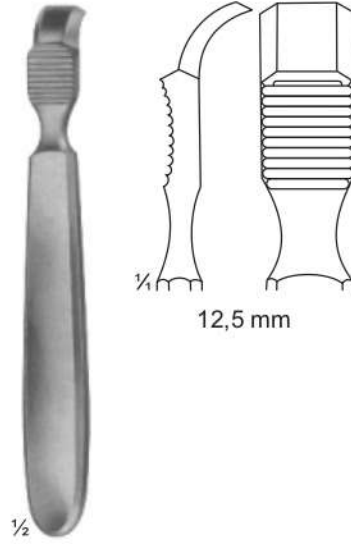

12,5 mm

**10-258**  
FARABEU  
140 mm

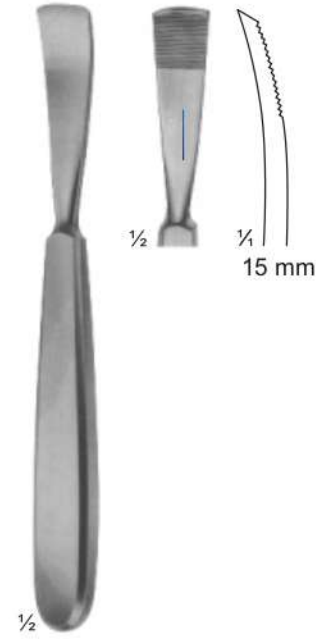

15 mm

**10-259**  
JANSEN  
165 mm

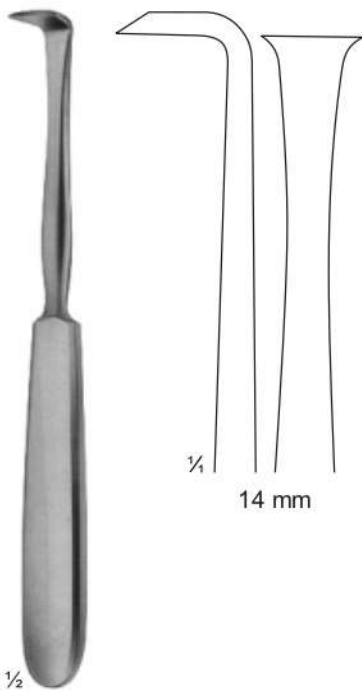

14 mm

**10-260**  
LANGENBECK  
180 mm

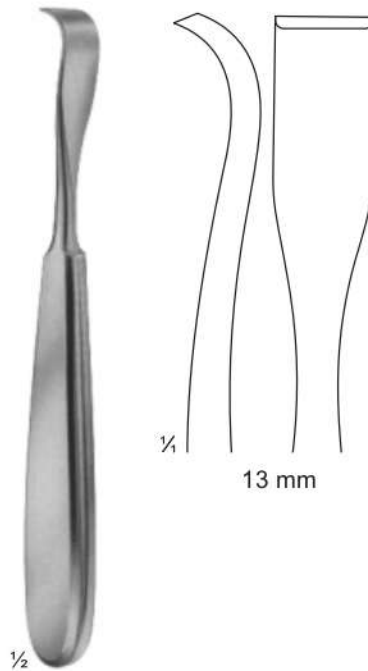

13 mm

**10-261**  
SCHNEIDER  
175 mm

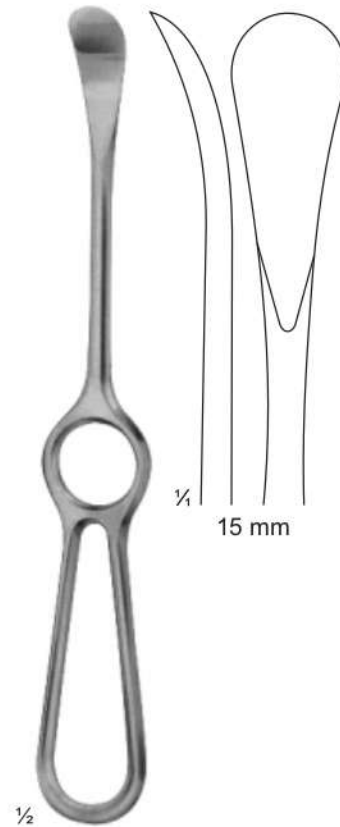

15 mm

**10-262**  
SEDILLOT  
215 mm

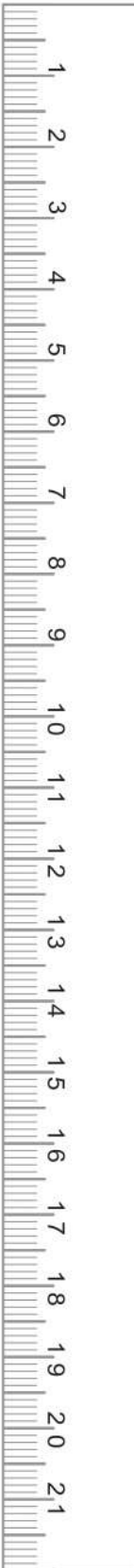



**10-263**  
275 mm



20 mm

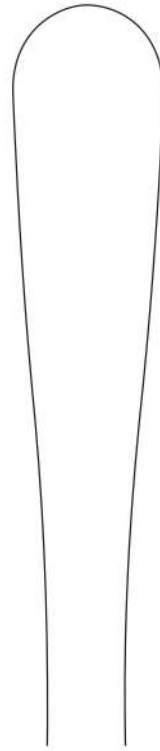

**10-264 - 265**  
WAGNER  
330 mm

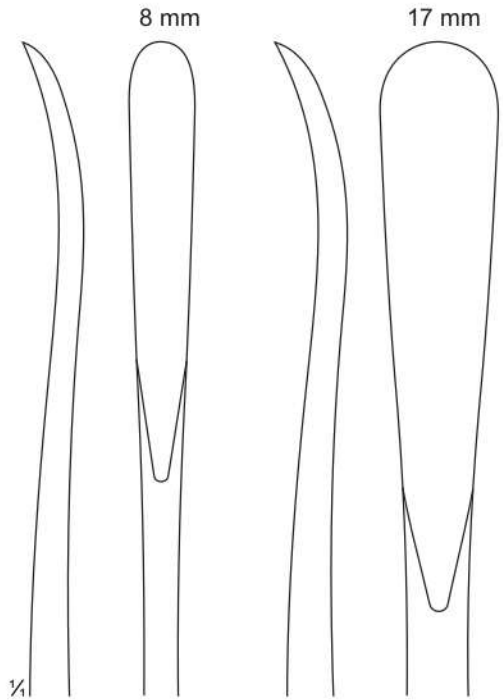

**10-264**

**10-265**



**10-266**  
**JACOBSON**  
 140 mm



**10-267**  
**MARTINI**  
 140 mm



**10-268**  
**MARTINI**  
 140 mm



**10-269**  
**WILLIGER**  
 145 mm



**10-270**  
**JANSEN**  
 160 mm



**10-271**  
**BARTH**  
 180 mm

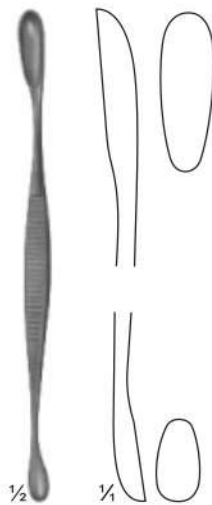

**10-272**  
**VOLKMANN**  
 130 mm

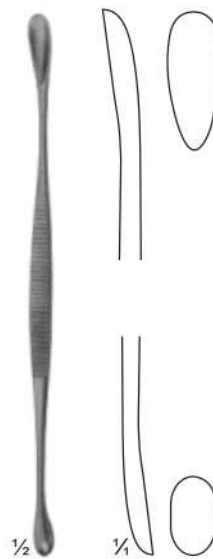

**10-273**  
**VOLKMANN**  
 145 mm



**10-274**  
**VOLKMANN**  
 170 mm

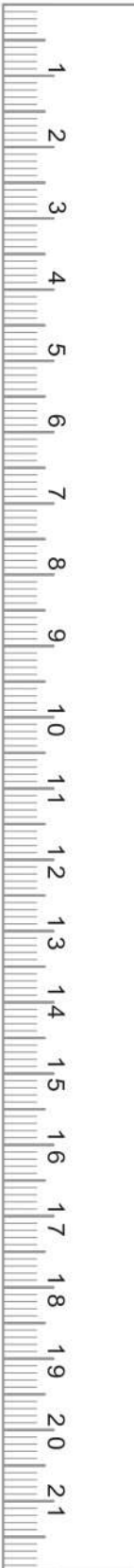

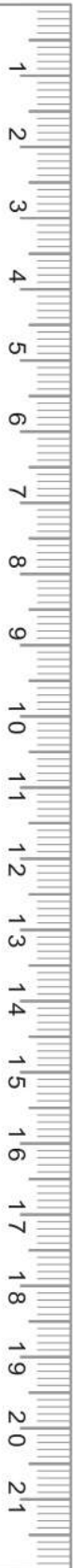

**10-275**  
JANSEN  
160 mm



**10-276**  
HEMINGWAY  
170 mm



**10-277**  
HEMINGWAY  
175 mm



**10-278**  
LUCAS  
180 mm



**10-279**  
LUCAS  
185 mm



**10-280 - 281**  
KERPEL  
145 mm



**10-282 - 283**  
KERPEL  
145 mm

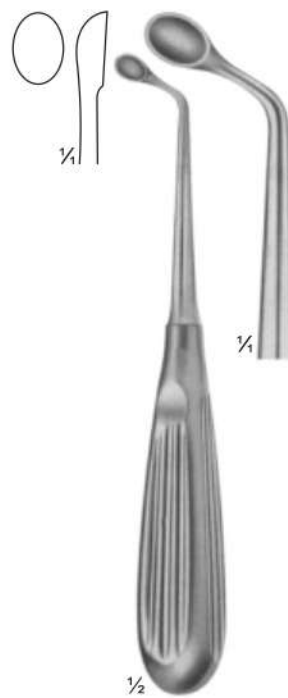

**10-284**  
UFFENDORDE  
170 mm



**10-285**  
UFFENDORDE  
170 mm



**10-286 - 292**  
**BRUNS**  
 165 mm

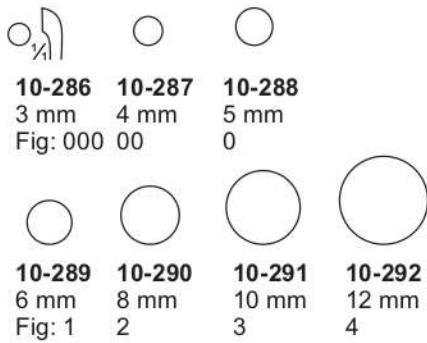

**10-293 - 299**  
**SCHEDE**  
 170 mm

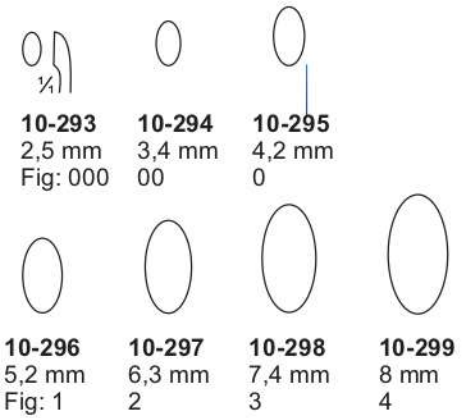

**10-300 - 309**  
**VOLKMANN**  
 170 mm

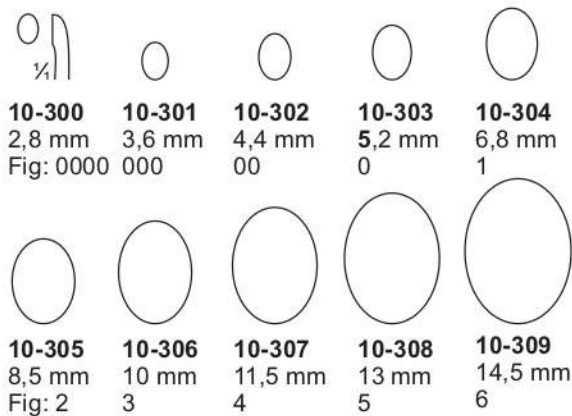

**10-310 - 311**  
**WILLIGER**  
 170 mm

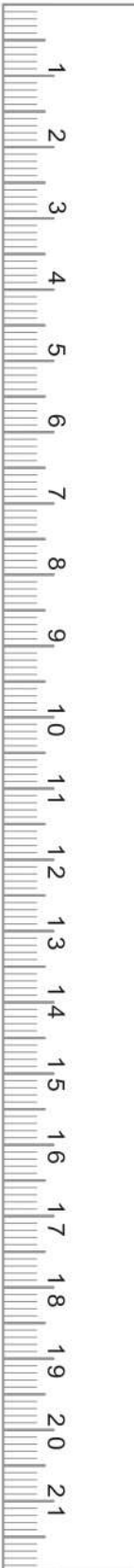
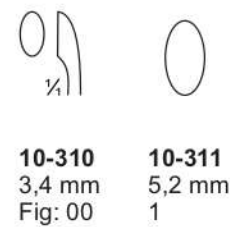

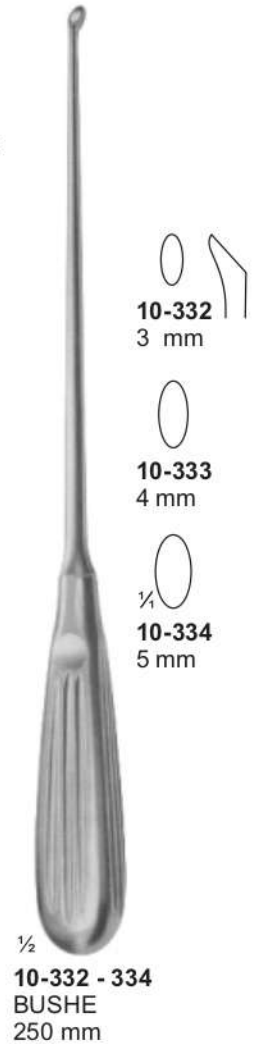
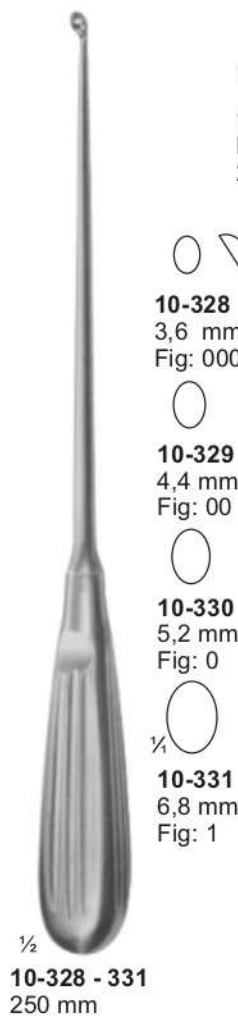
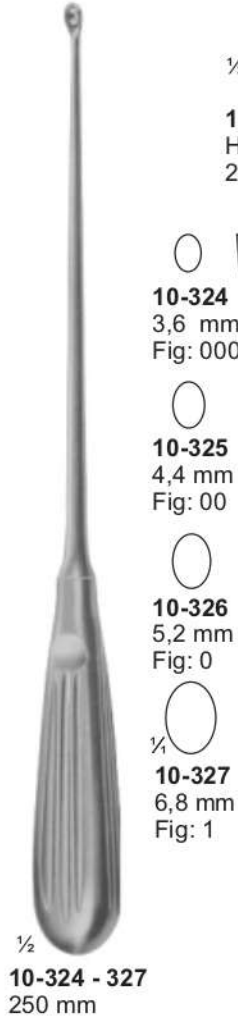
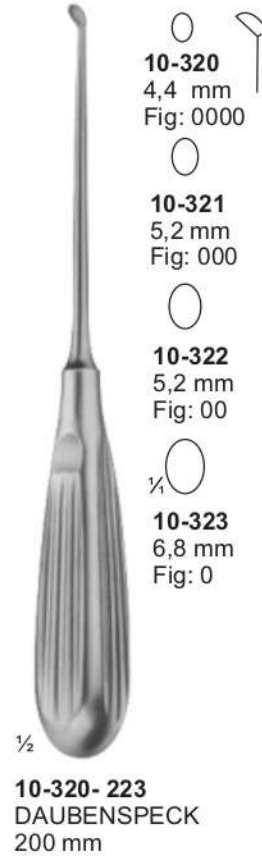
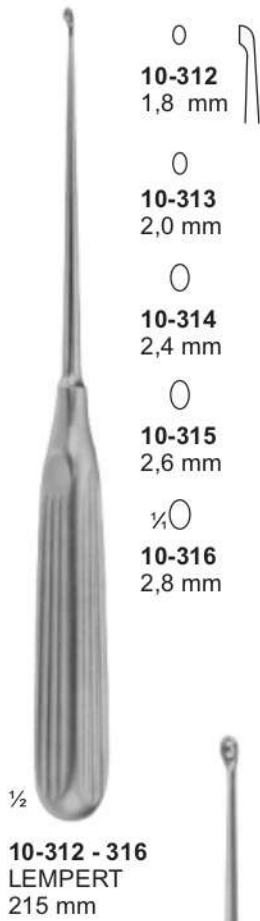
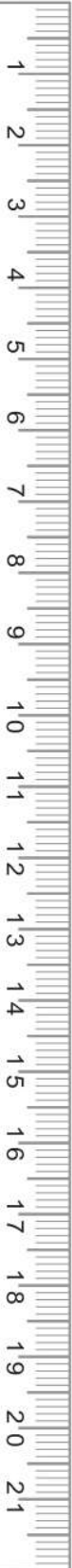



∅20 mm

½

**10-335**  
MEAD  
185 g  
with interchangeable  
plastic disks  
190 mm  
**10-336**  
pair of spare disks



½

**10-337**  
140 g  
with interchangeable  
plastic disks  
185 mm  
**10-338**  
pair of spare disks



∅25 mm

½

**10-339**  
COTTLE  
140 g  
1 Seite convex  
1 Side convex  
185 mm



∅22 mm

½

**10-340**  
165 g  
lead filled head  
190 mm

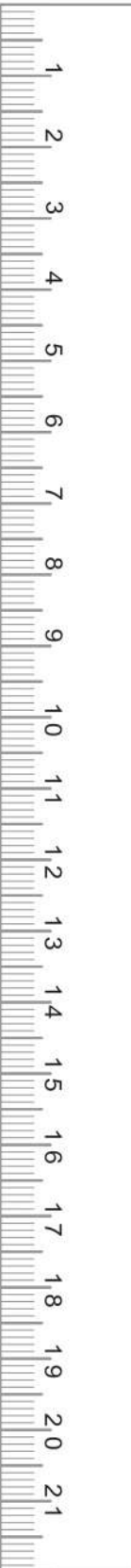



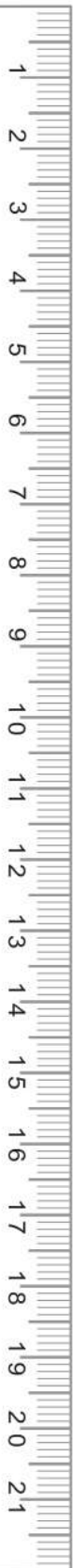

**10-341**  
**Mannerfelt**  
 155 mm

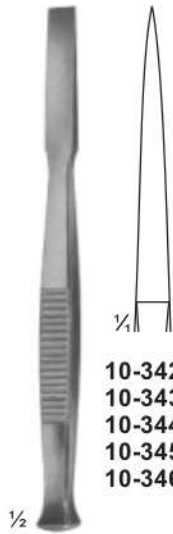

**10-342 - 346**  
**Osteotome**  
 140 mm

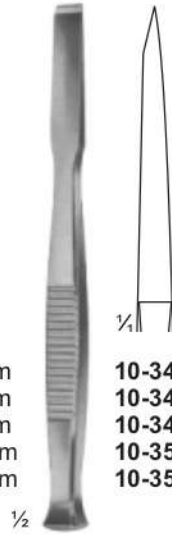

**10-347 - 351**  
**Chisels**  
 140 mm

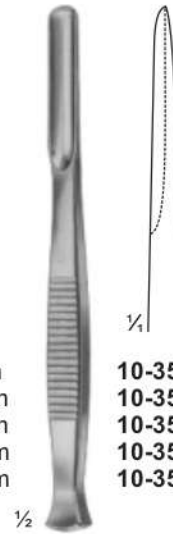

**10-352 - 356**  
**Gouges**  
 140 mm

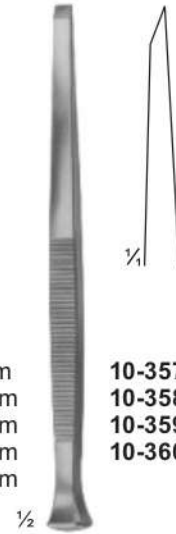

**PARTSCH**  
**10-357 - 360**  
**CHISELS**  
 140 mm

**10-342** 4 mm  
**10-343** 6 mm  
**10-344** 8 mm  
**10-345** 10 mm  
**10-346** 12 mm

**10-347** 4 mm  
**10-348** 6 mm  
**10-349** 8 mm  
**10-350** 10 mm  
**10-351** 12 mm

**10-352** 4 mm  
**10-353** 6 mm  
**10-354** 8 mm  
**10-355** 10 mm  
**10-356** 12 mm

**10-357** 3 mm  
**10-358** 4 mm  
**10-359** 5 mm  
**10-360** 6 mm

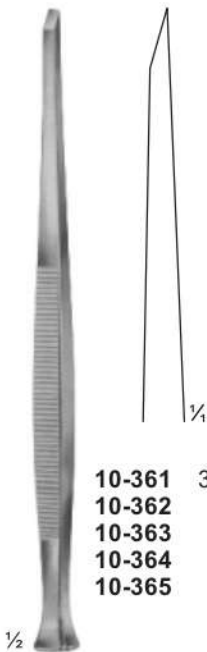

**PARTSCH**  
**10-361 - 365**  
**Chisels**  
 170 mm

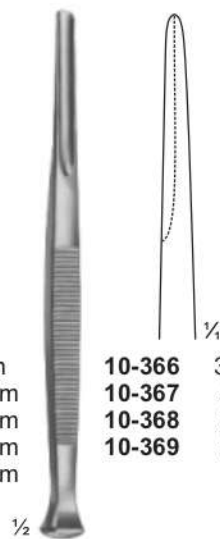

**PARTSCH**  
**10-366 - 369**  
**Gouges**  
 140 mm

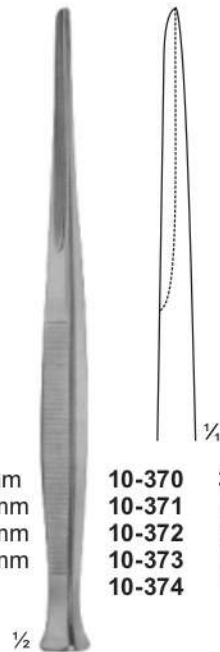

**PARTSCH**  
**10-370 - 374**  
**Gouges**  
 170 mm



**LUCAS**  
**10-375 - 376**  
**Chisels**  
 160 mm



**LUCAS**  
**10-377 - 378**  
**Gouges**  
 160 mm

**10-361** 3 mm  
**10-362** 4 mm  
**10-363** 5 mm  
**10-364** 6 mm  
**10-365** 7 mm

**10-366** 3 mm  
**10-367** 4 mm  
**10-368** 5 mm  
**10-369** 6 mm

**10-370** 3 mm  
**10-371** 4 mm  
**10-372** 5 mm  
**10-373** 6 mm  
**10-374** 7 mm

**10-375** 4 mm  
**10-376** 6 mm

**10-377** 3 mm  
**10-378** 5 mm



# Osteotomes Chisels And Gouges Osteotome Und Meißel Gouges Osteotomos Cinceles Y Gubias

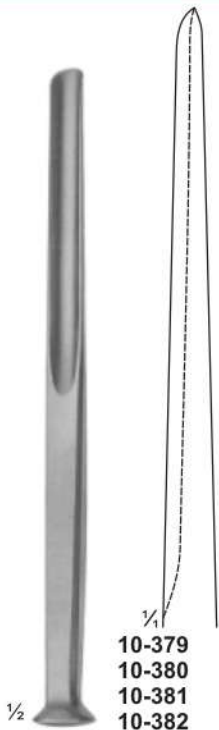

**ALEXANDER**  
**10-379-382**  
Gouges  
170 mm

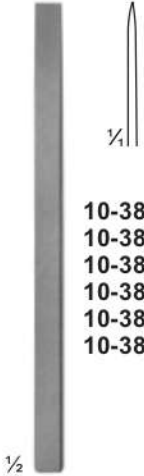

**LAMBOTTE**  
**10-383-388**  
Osteotome  
125 mm

- |               |       |
|---------------|-------|
| <b>10-383</b> | 4 mm  |
| <b>10-384</b> | 6 mm  |
| <b>10-385</b> | 8 mm  |
| <b>10-386</b> | 10 mm |
| <b>10-387</b> | 12 mm |
| <b>10-388</b> | 15 mm |

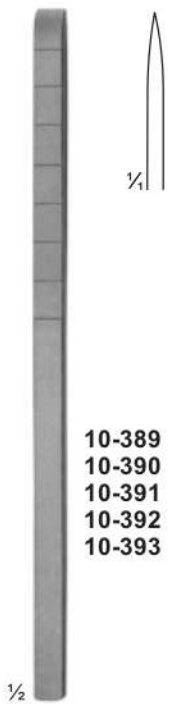

**COTTLE**  
**10-389-393**  
Osteotome with depth markings  
180 mm

- |               |       |
|---------------|-------|
| <b>10-389</b> | 4 mm  |
| <b>10-390</b> | 6 mm  |
| <b>10-391</b> | 8 mm  |
| <b>10-392</b> | 10 mm |
| <b>10-393</b> | 12 mm |

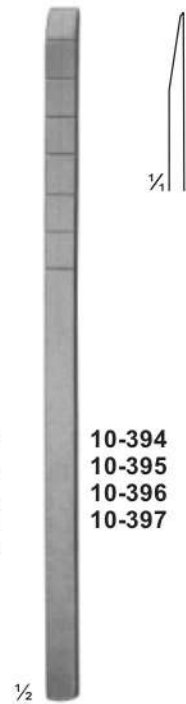

**COTTLE**  
**10-394-397**  
Chisel-Osteotomes with depth markings  
180 mm

- |               |       |
|---------------|-------|
| <b>10-394</b> | 4 mm  |
| <b>10-395</b> | 7 mm  |
| <b>10-396</b> | 9 mm  |
| <b>10-397</b> | 12 mm |



**COTTLE**  
**10-398**  
Fishtail Chisel, with protected ends  
180 mm

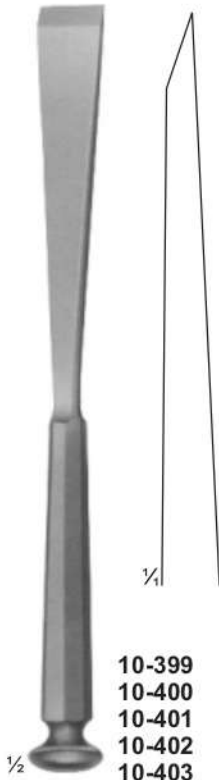

**STILLE**  
**10-399-403**  
Chisels  
205 mm

- |               |       |
|---------------|-------|
| <b>10-399</b> | 10 mm |
| <b>10-400</b> | 12 mm |
| <b>10-401</b> | 15 mm |
| <b>10-402</b> | 20 mm |
| <b>10-403</b> | 25 mm |

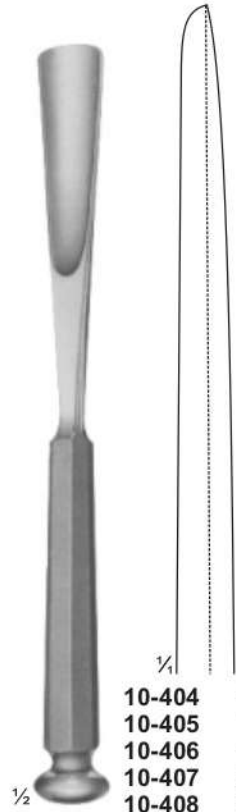

**STILLE**  
**10-404-408**  
Gouges  
205 mm

- |               |       |
|---------------|-------|
| <b>10-404</b> | 10 mm |
| <b>10-405</b> | 12 mm |
| <b>10-406</b> | 15 mm |
| <b>10-407</b> | 20 mm |
| <b>10-408</b> | 25 mm |

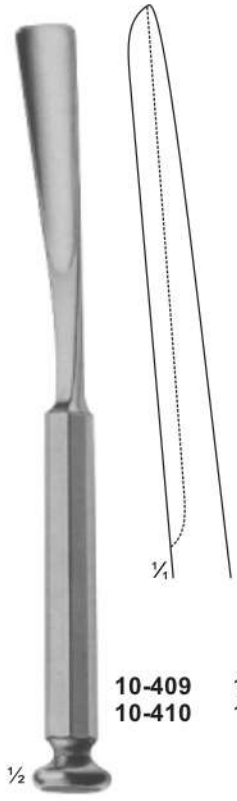

**WALTER**  
**10-409-410**  
Osteotomes gouges for taking grafts from the rib  
205 mm

- |               |       |
|---------------|-------|
| <b>10-409</b> | 10 mm |
| <b>10-410</b> | 15 mm |



**STILLE**  
**10-411-415**  
Osteotomes  
205 mm

- |               |       |
|---------------|-------|
| <b>10-411</b> | 8 mm  |
| <b>10-412</b> | 12 mm |
| <b>10-413</b> | 15 mm |
| <b>10-414</b> | 20 mm |
| <b>10-415</b> | 25 mm |



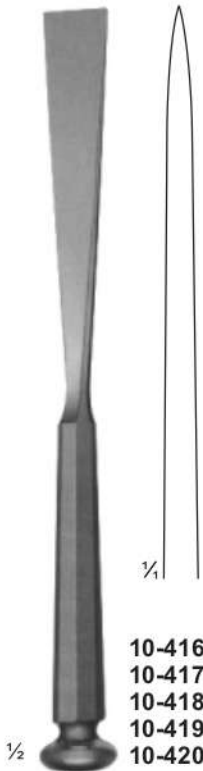
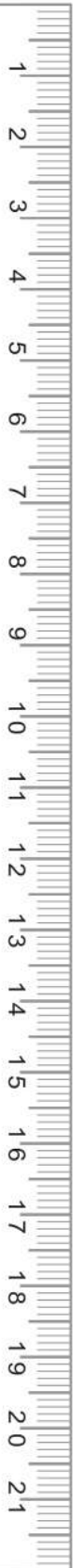

<b>10-416</b>	10 mm
<b>10-417</b>	12 mm
<b>10-418</b>	15 mm
<b>10-419</b>	20 mm
<b>10-420</b>	25 mm

**STILLE**  
**10-416 - 420**  
Osteotomes  
205 mm



<b>10-421</b>	10 mm
<b>10-422</b>	12 mm
<b>10-423</b>	15 mm
<b>10-424</b>	20 mm
<b>10-425</b>	25 mm

**STILLE**  
**10-421 - 425**  
Osteotomes, curved  
205 mm

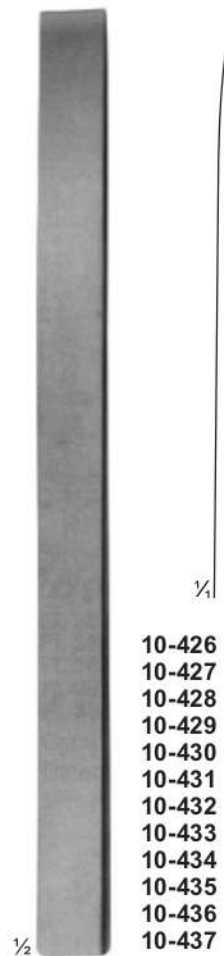

<b>10-426</b>	4 mm
<b>10-427</b>	8 mm
<b>10-428</b>	10 mm
<b>10-429</b>	13 mm
<b>10-430</b>	15 mm
<b>10-431</b>	18 mm
<b>10-432</b>	20 mm
<b>10-433</b>	25 mm
<b>10-434</b>	30 mm
<b>10-435</b>	38 mm
<b>10-436</b>	44 mm
<b>10-437</b>	50 mm

**LAMBOTTE**  
**10-426 - 337**  
Osteotomes  
245 mm

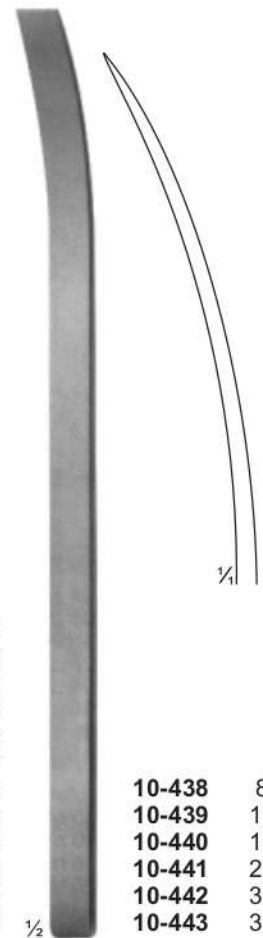

<b>10-438</b>	8 mm
<b>10-439</b>	13 mm
<b>10-440</b>	18 mm
<b>10-441</b>	25 mm
<b>10-442</b>	30 mm
<b>10-443</b>	38 mm

**LAMBOTTE**  
**10-438 - 443**  
Osteotomes, curved  
245 mm

**Osteotomes, chisels And Gouges With Hartpre**  
**Osteotome, Meißel Und Gouges Mit Hartpress**  
**Osteotomos, Cinceles Y Gubias Con Hartpress**



**MATU BROTHERS  
SURGICAL**

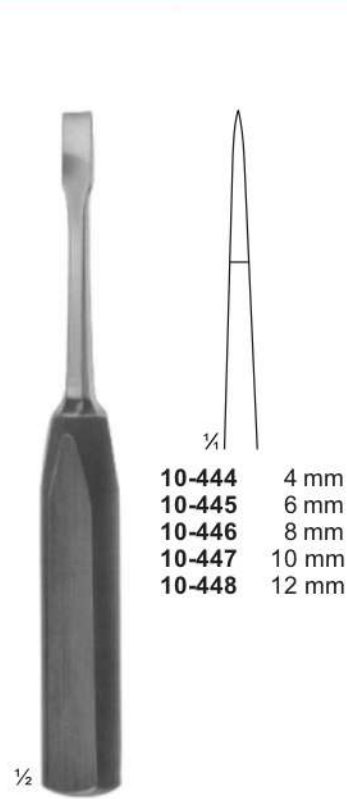

- 10-444** 4 mm
- 10-445** 6 mm
- 10-446** 8 mm
- 10-447** 10 mm
- 10-448** 12 mm

**LEXER-MINI**  
**10-444 - 448**  
 Osteotomes  
 180 mm

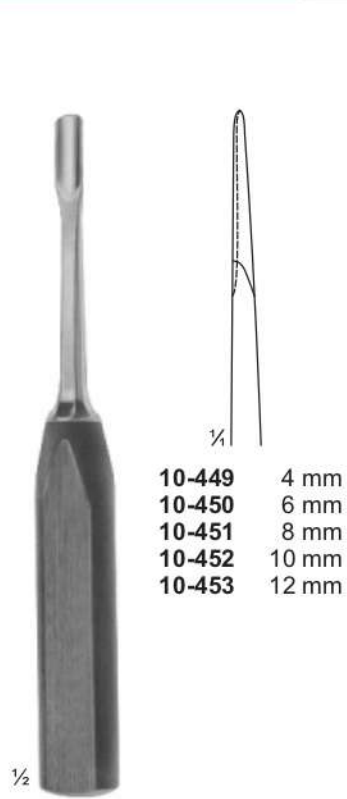

- 10-449** 4 mm
- 10-450** 6 mm
- 10-451** 8 mm
- 10-452** 10 mm
- 10-453** 12 mm

**LEXER-MINI**  
**10-449 - 453**  
 Gouges  
 180 mm

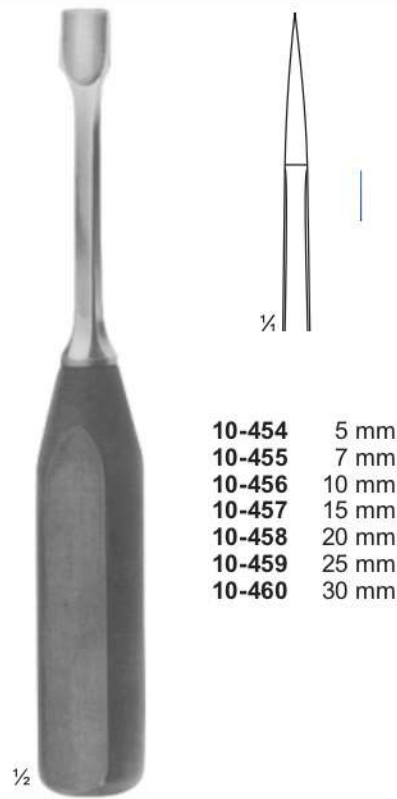

- 10-454** 5 mm
- 10-455** 7 mm
- 10-456** 10 mm
- 10-457** 15 mm
- 10-458** 20 mm
- 10-459** 25 mm
- 10-460** 30 mm

**LEXER**  
**10-454 - 460**  
 Osteotomes  
 220 mm

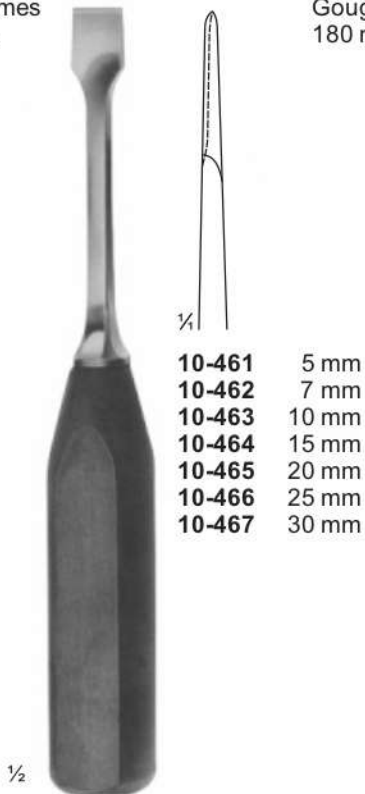

- 10-461** 5 mm
- 10-462** 7 mm
- 10-463** 10 mm
- 10-464** 15 mm
- 10-465** 20 mm
- 10-466** 25 mm
- 10-467** 30 mm

**LEXER**  
**10-461 - 467**  
 Gouges  
 220 mm

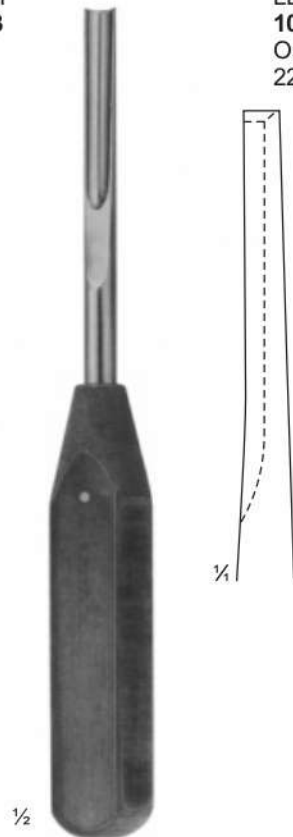

**LEXER**  
**10-468**  
 Gouge for  
 removing broken  
 screws  
 220 mm

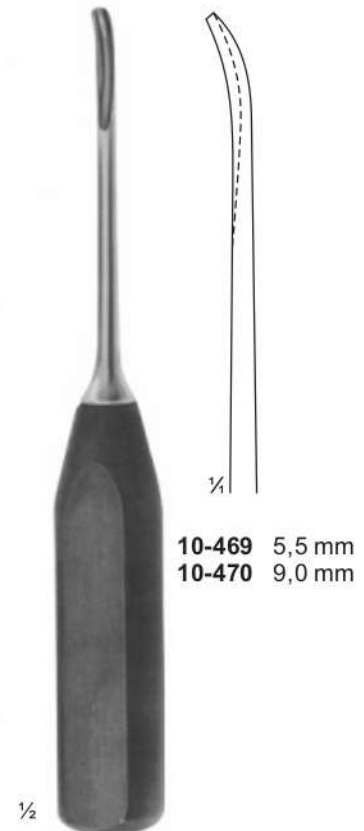

- 10-469** 5,5 mm
- 10-470** 9,0 mm

**ZIELKE**  
**10-469 - 470**  
 Gouge for  
 scoliosis-operations  
 230 mm

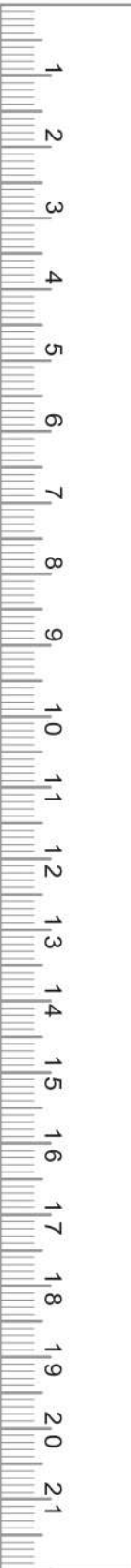

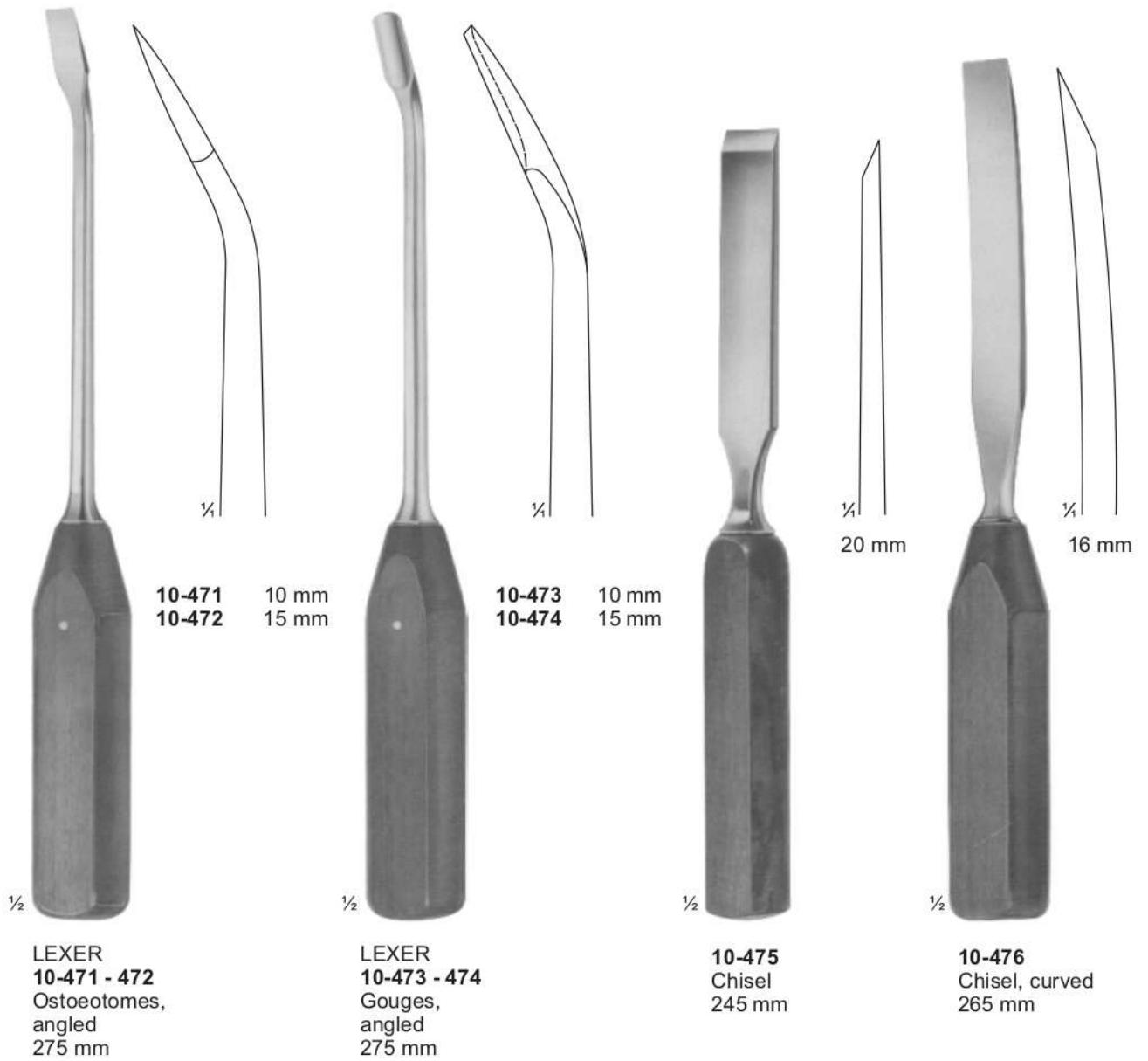
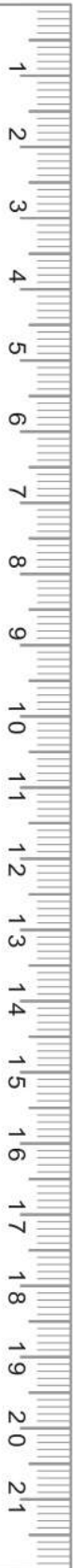



**Bone Holding Forceps**  
Knochenhaltezangen  
Bone Pinzas



**10-477**  
KERN-LANE  
240 mm



**10-478**  
LANE  
330 mm



**10-479**  
KERN-LANE  
240 mm

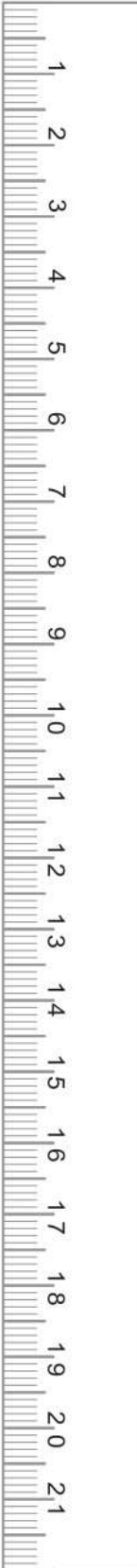

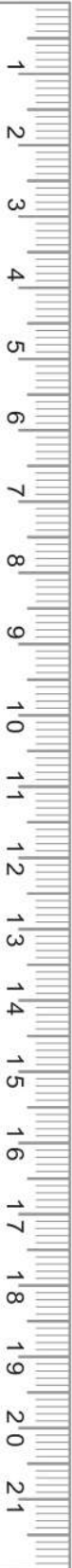

1/2

**10-480 - 484**

- 10-480** 145 mm
- 10-481** 190 mm
- 10-482** 240 mm
- 10-483** 260 mm
- 10-484** 280 mm



3 mm

1/2

**10-480**  
for small  
fragments

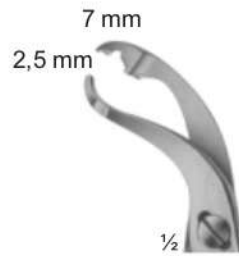

7 mm  
2,5 mm

1/2

**10-481**  
Fig: 0

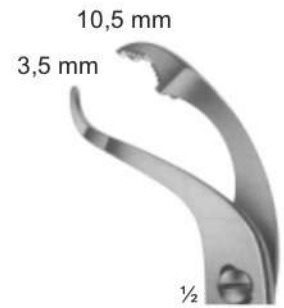

10,5 mm  
3,5 mm

1/2

**10-482**  
Fig: 1



11 mm  
3,5 mm

1/2

Self-centering forceps  
with thread fixation

**10-483**  
Fig: 2

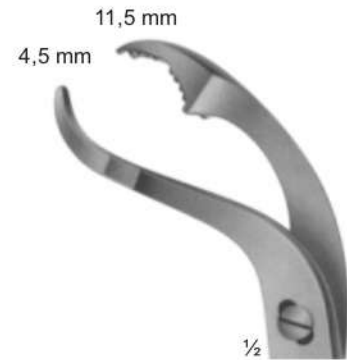

11,5 mm  
4,5 mm

1/2

**10-484**  
Fig: 3

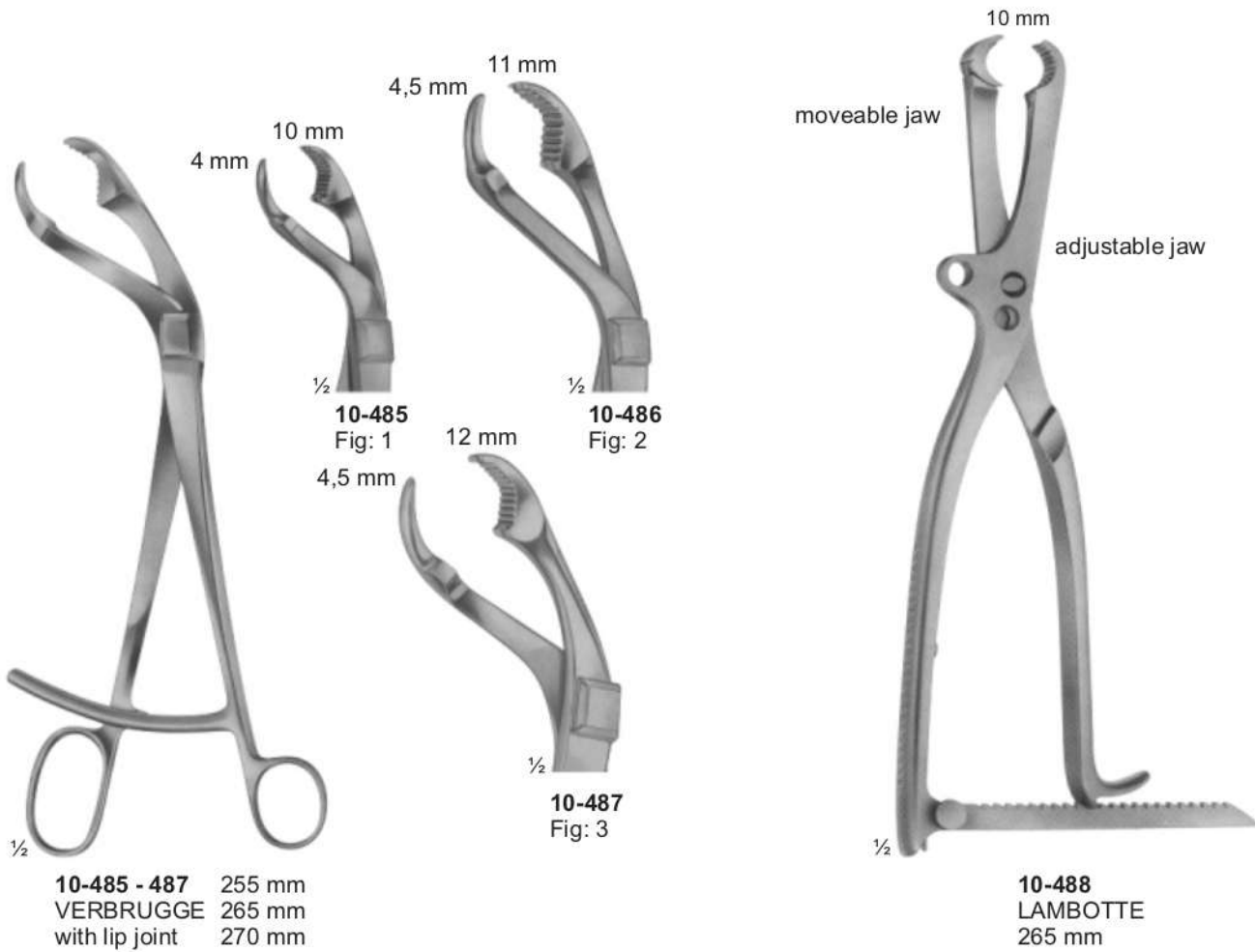



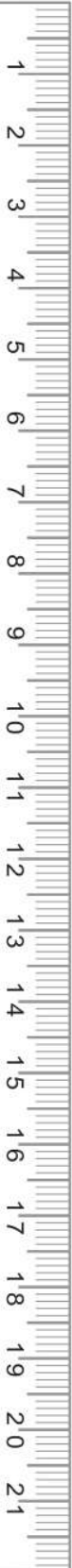

**10-489 - 490**  
LOWMAN  
**10-489** 170 mm  
**10-490** 205 mm



**10-491**  
LOWMAN-GERSTER  
210 mm



**10-492**  
LOWMAN-HOGLUND  
175 mm

**Synovectomy-rongeurs, Bone Rongeurs**  
**Synovektomie-rongeurs Bone Rongeurs**  
**Rongeurs Sinovectomía, Hueso Rongeurs**

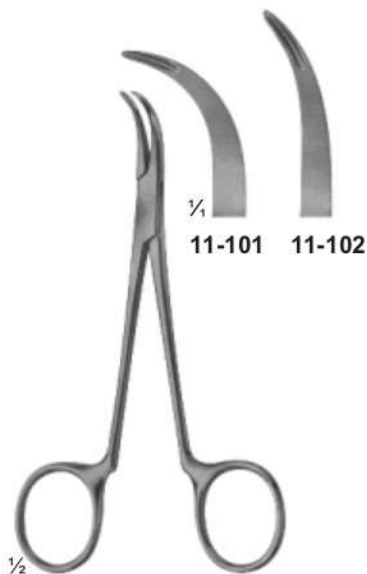

**11-101 - 102**  
 Synovctomy rongeur  
 width of jaws 1.2 mm  
 130 mm

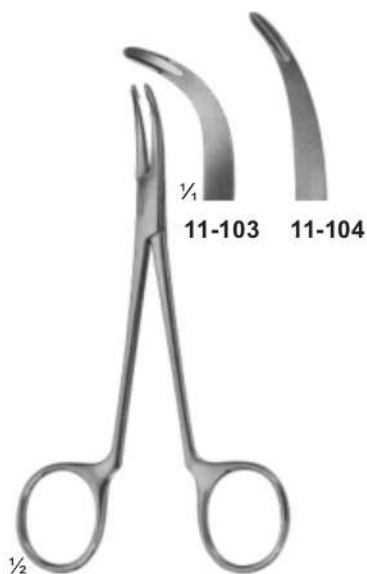

**11-103 - 104**  
 Synovctomy rongeur  
 width of jaws 2.0 mm  
 130 mm

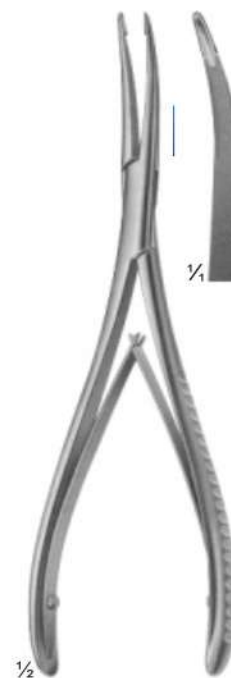

**11-105**  
**STELLBRINK**  
 Synovectomy rongeur  
 175 mm

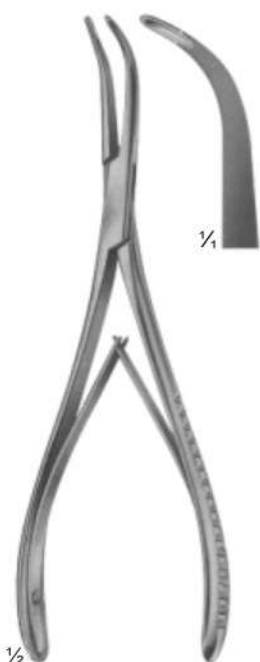

**11-106**  
**STELLBRINK**  
 Synovectomy rongeur  
 170 mm



**11-107**  
**LURE-FRIEDMANN**  
 145 mm



**11-108**  
 140 mm



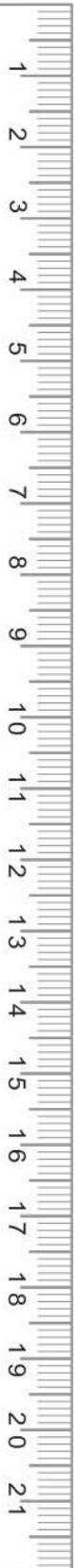

**11-109**  
LURE  
150 mm



**11-110**  
LURE  
155 mm

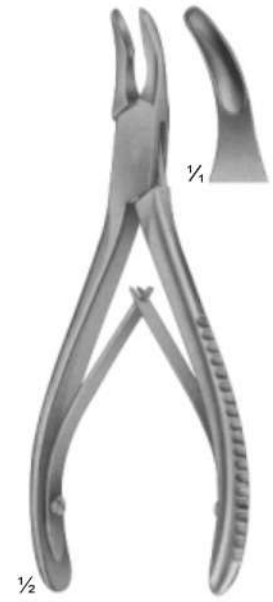

**11-111**  
BLUMENTHAL  
155 mm



**11-112**  
BLUMENTHAL  
150 mm



**11-113 - 114**  
JANSEN  
175 mm

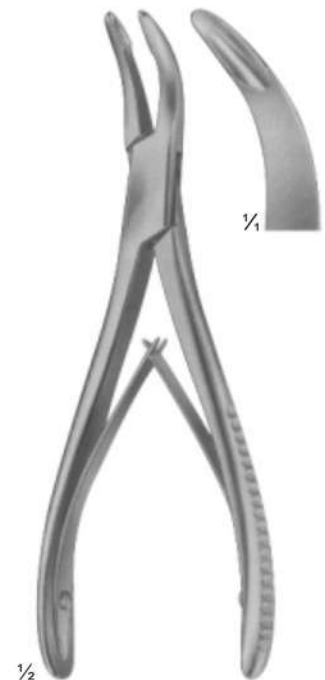

**11-114**  
BANE-HARTMANN  
175 mm

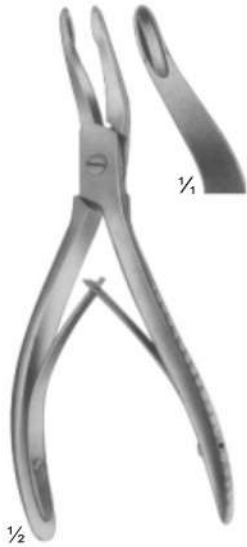

**11-115**  
**ALEXANDER**  
 140 mm

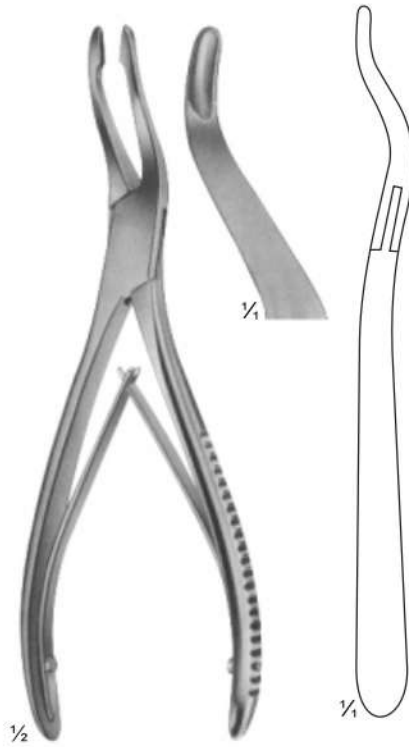

**11-116**  
**JANSEN**  
 190 mm

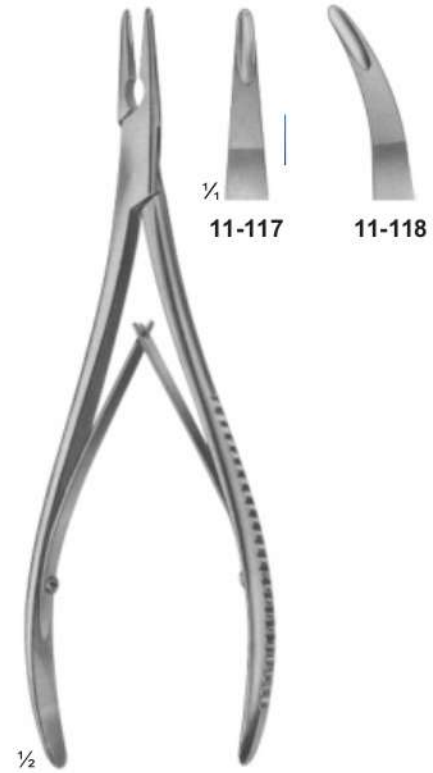

**11-117 - 118**  
**LEMPERT**  
 200 mm

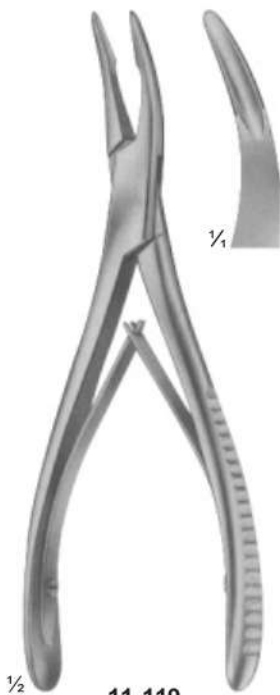

**11-119**  
**BEYER**  
 180 mm

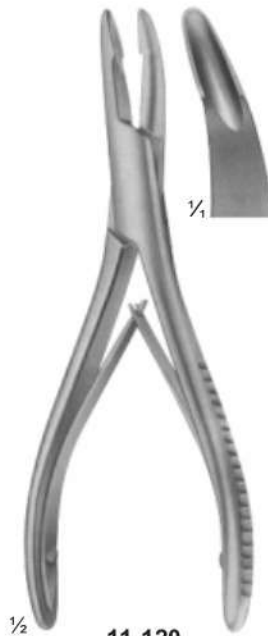

**11-120**  
**MEAD**  
 165 mm

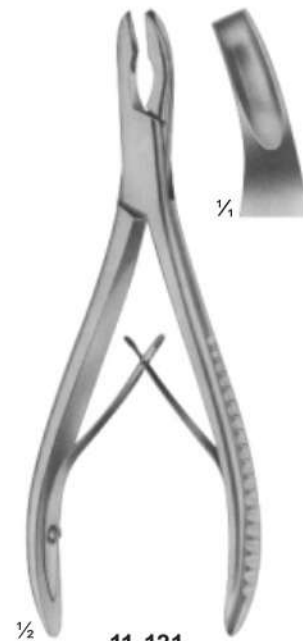

**11-121**  
**MEAD**  
 165 mm

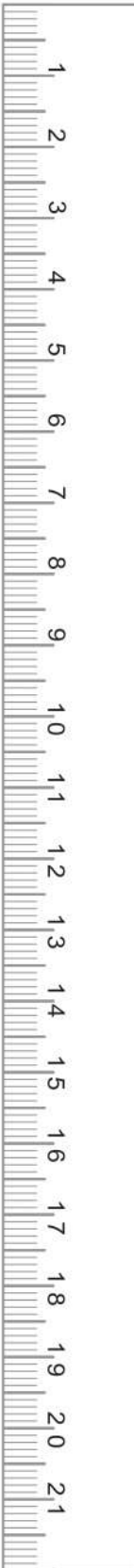

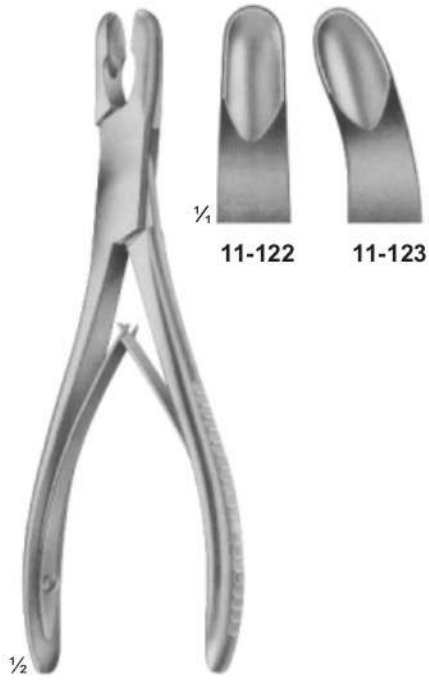
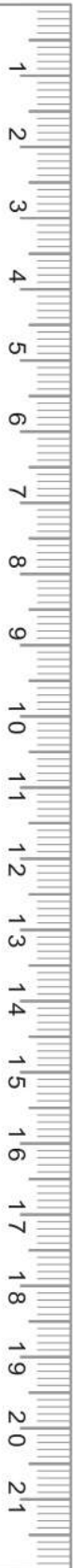

$\frac{1}{4}$  11-122 11-123

$\frac{1}{2}$  11-122 - 123  
LURE  
175 mm

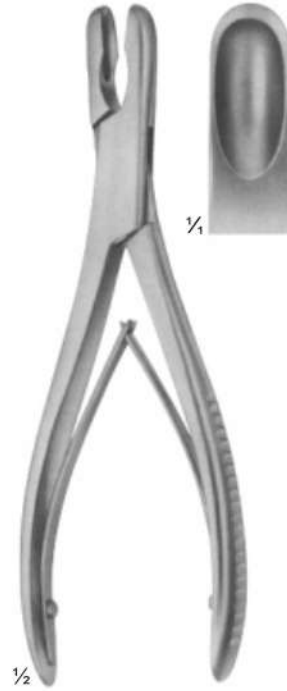

$\frac{1}{2}$  11-124  
LURE  
180 mm

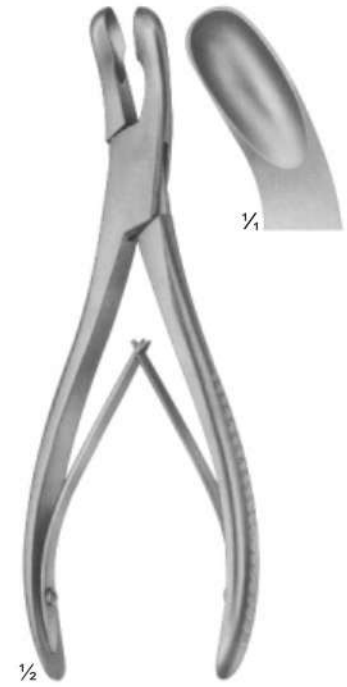

$\frac{1}{2}$  11-125  
LURE  
180 mm

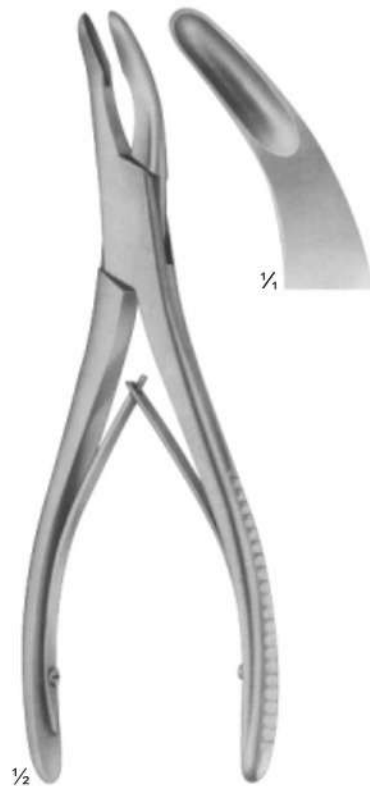

$\frac{1}{2}$  11-126  
OLIVECRONA  
205 mm



$\frac{1}{2}$  11-127 - 128  
BOHLER  
155 mm



$\frac{1}{2}$  11-129  
MARQUARDT  
200 mm

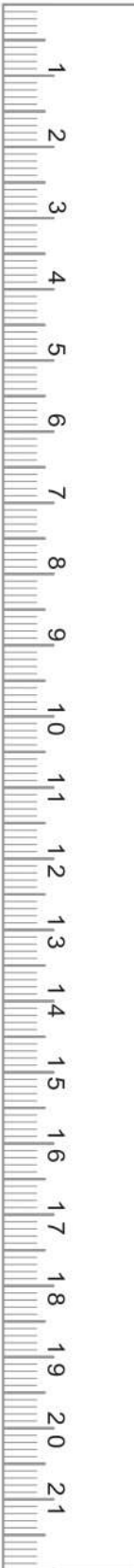
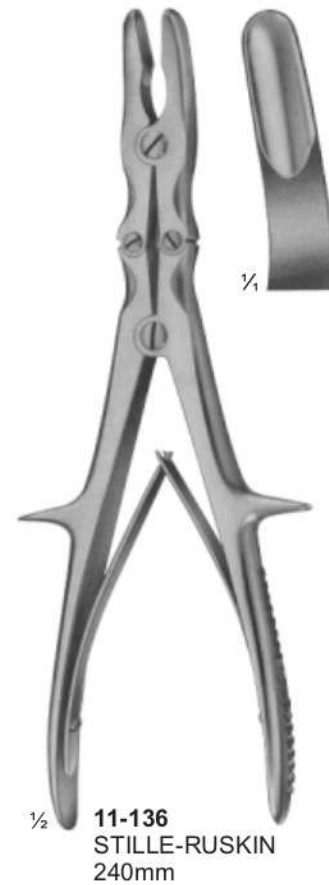
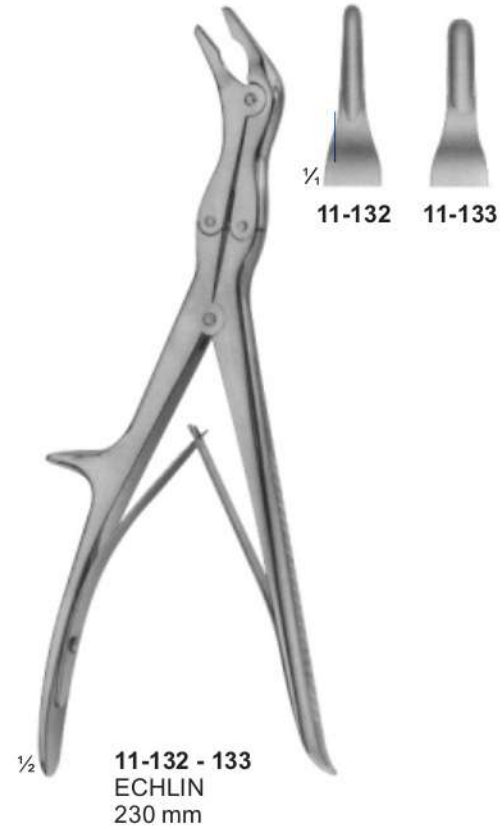

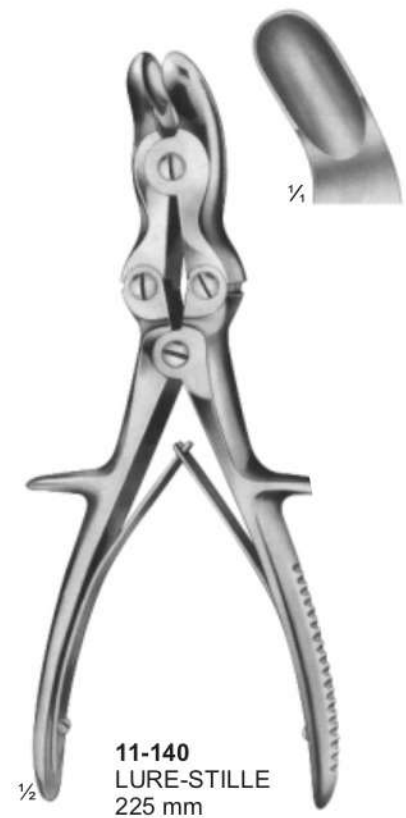
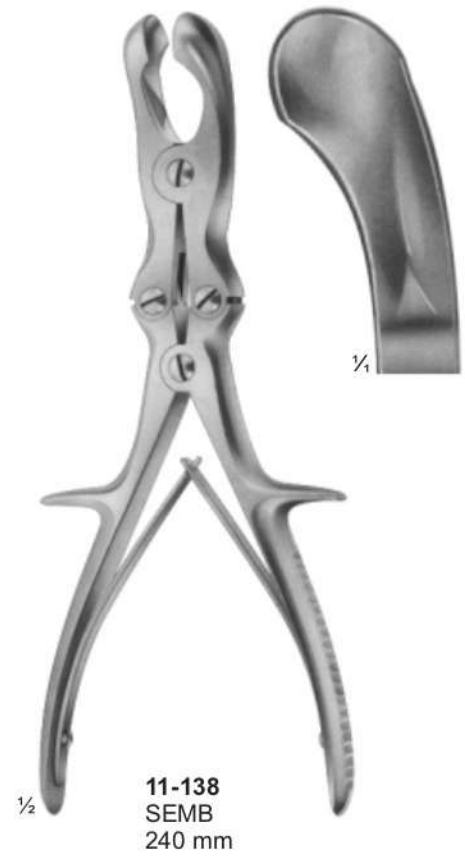
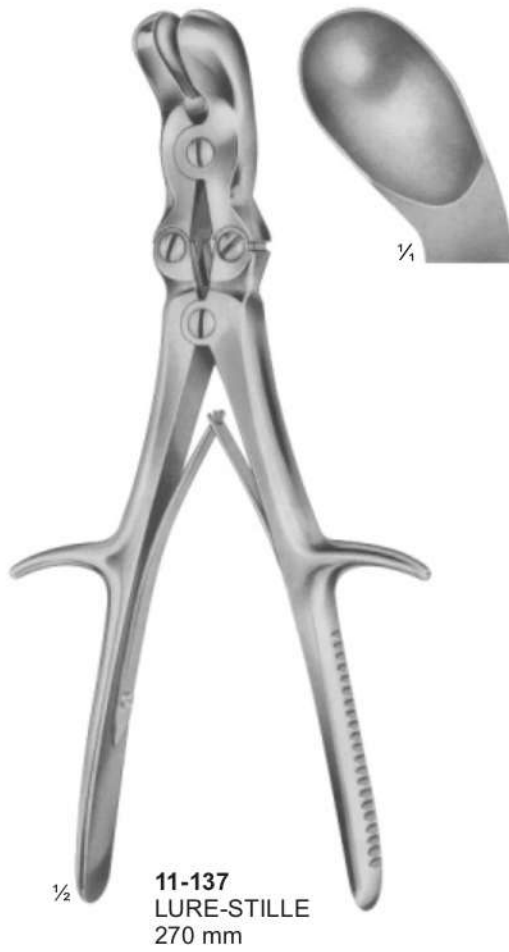



**Bone Cutting Forceps**  
Knochensplitterzangen  
Pinzas De Corte De Hueso



**11-141 - 144**  
LISTON



**11-141**  
140 mm



**11-142**  
170 mm



**11-143**  
200 mm



**11-144**  
220 mm



**11-145 - 147**  
LISTON



**11-145**  
170 mm



**11-146**  
200 mm

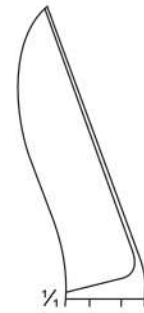

**11-147**  
220 mm

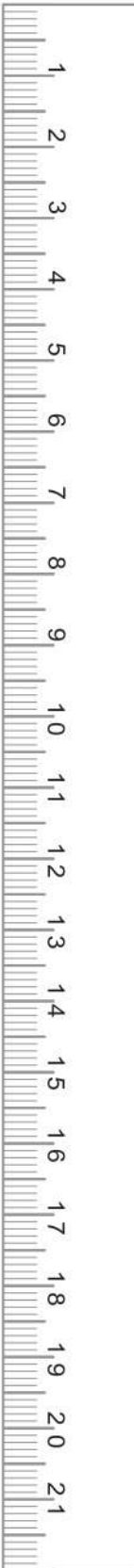



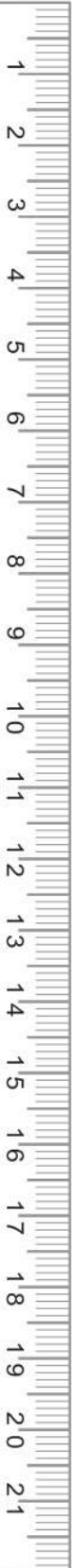

**11-148  
BOHLER  
145 mm**



**11-149  
RUSKIN-LISTON  
190 mm**

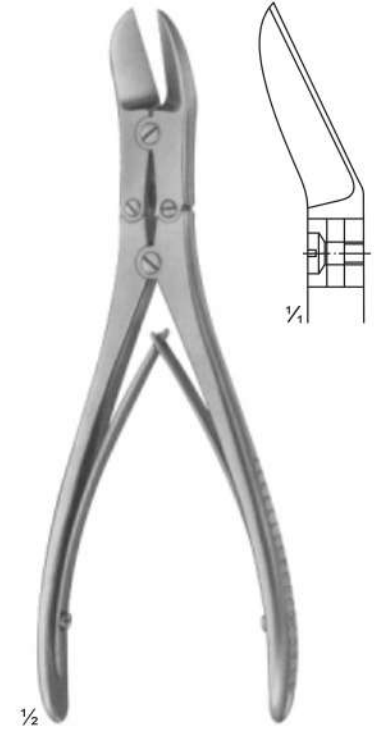

**11-150  
RUSKIN-LISTON  
190 mm**



**Bone Cutting Forceps**  
Knochensplitterzangen  
Pinzas De Corte De Hueso

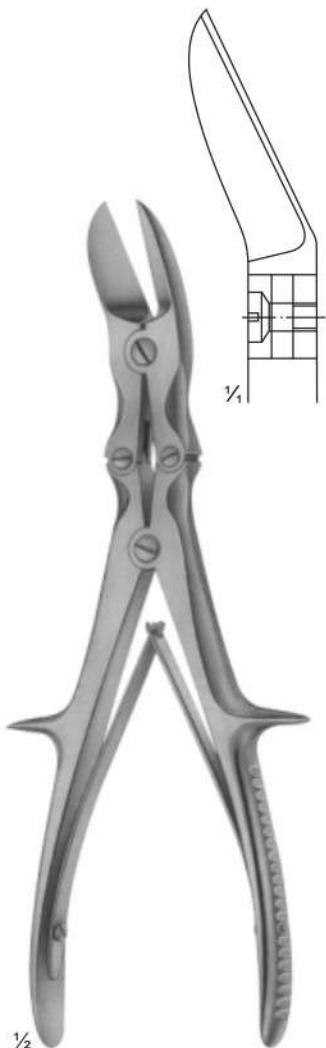

**11-151**  
LISTON  
curved on flat  
240 mm

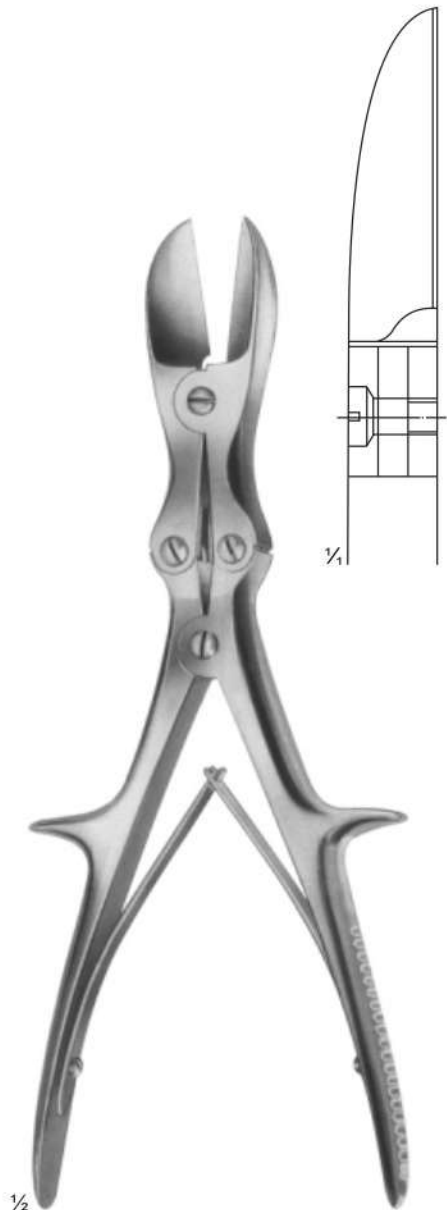

**11-152**  
LISTON  
straight  
280 mm

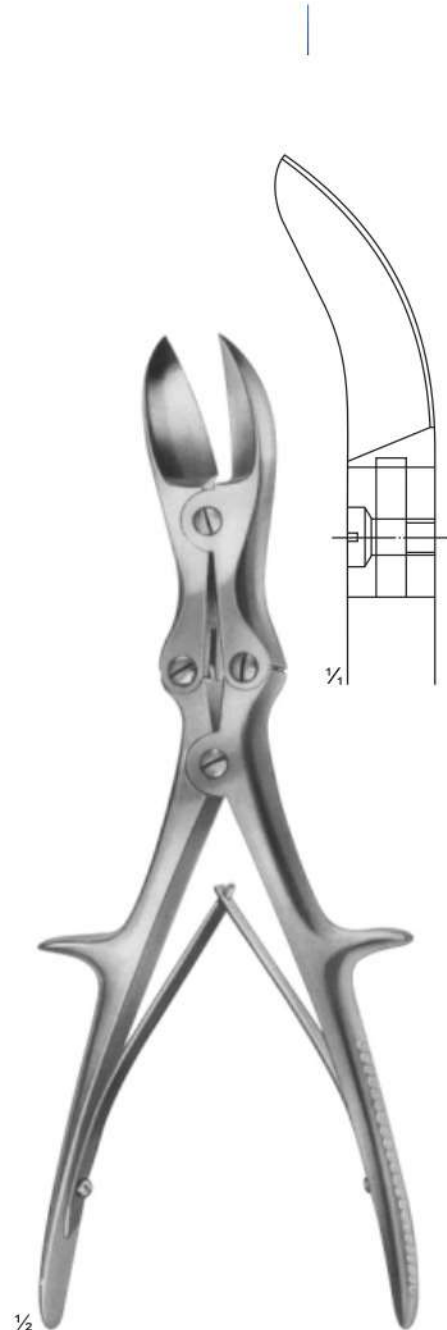

**11-153**  
LISTON  
curved on flat  
280 mm

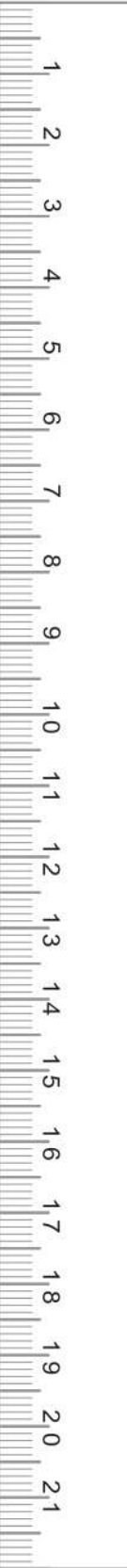

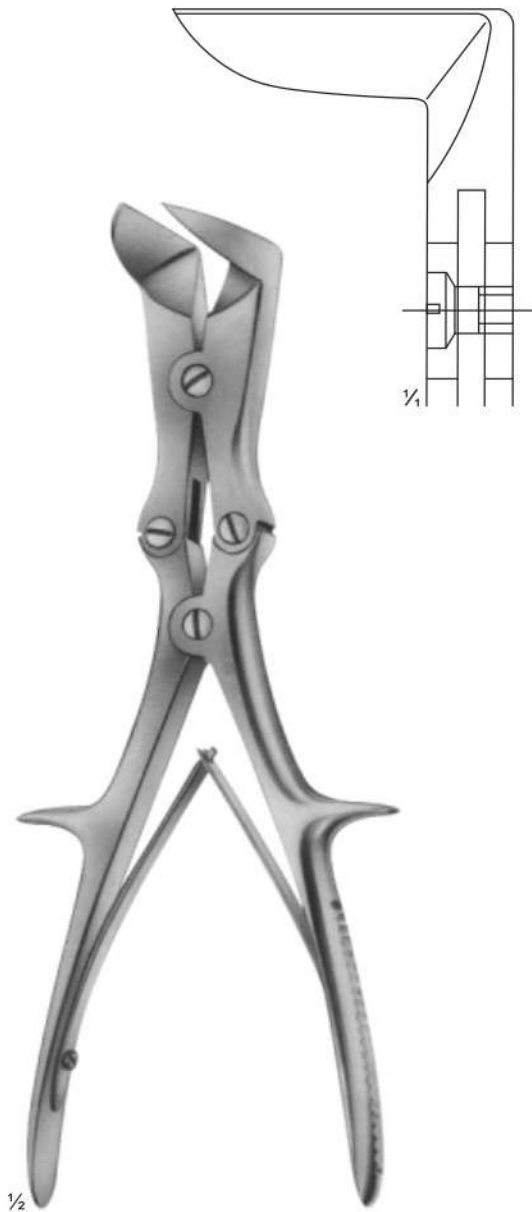

**11-154**  
LISTON-STILLE  
265 mm

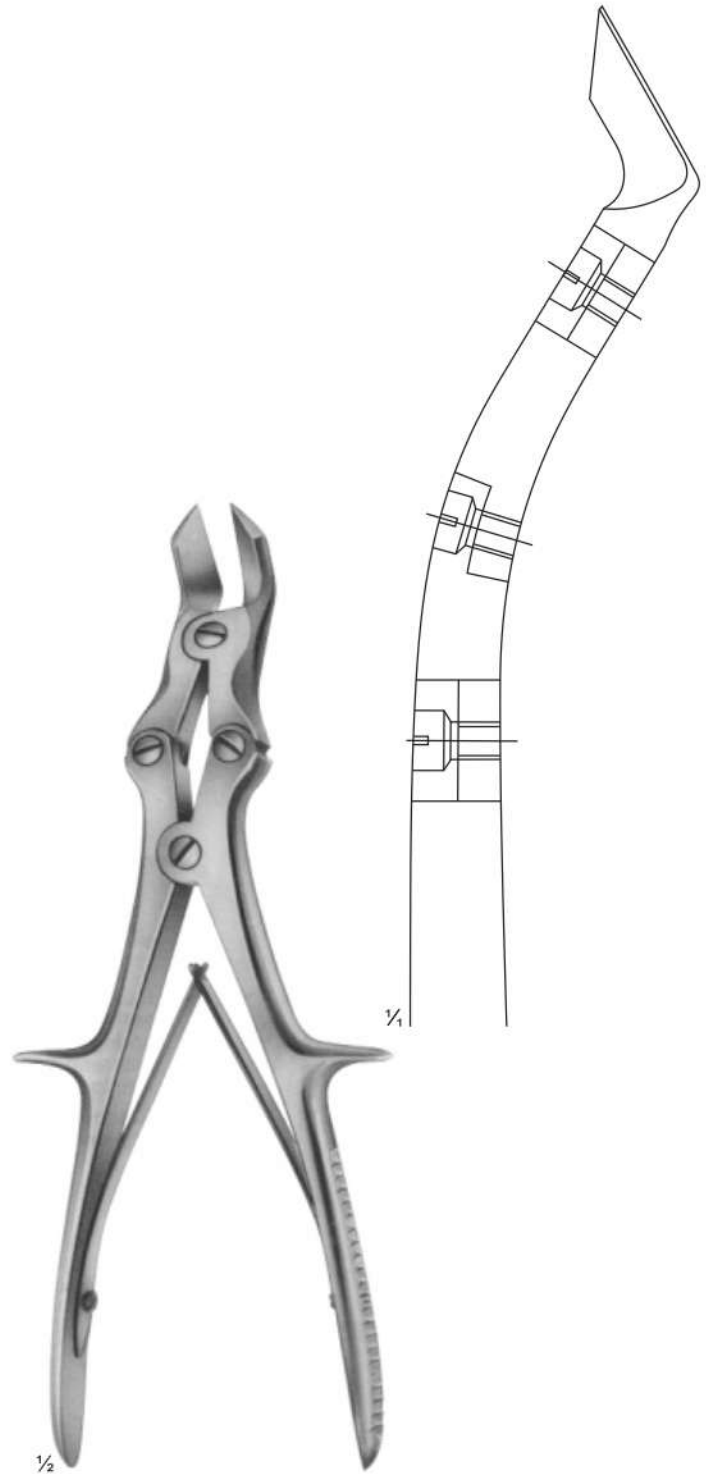

**11-155**  
LISTON-KEY-HORSLEY  
(TUDOR EDWARDS)  
255 mm

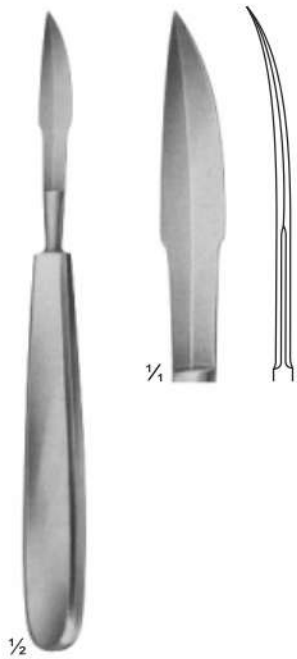

**11-156**  
 170 mm

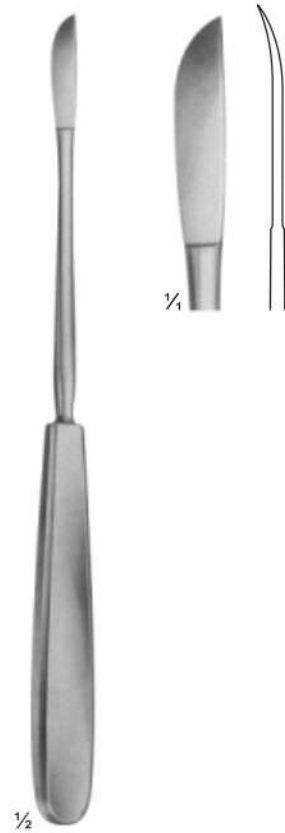

**11-157**  
 NEFF  
 215 mm



**11-158**  
 NEFF  
 215 mm



**11-159**  
 WAGNER  
 215 mm

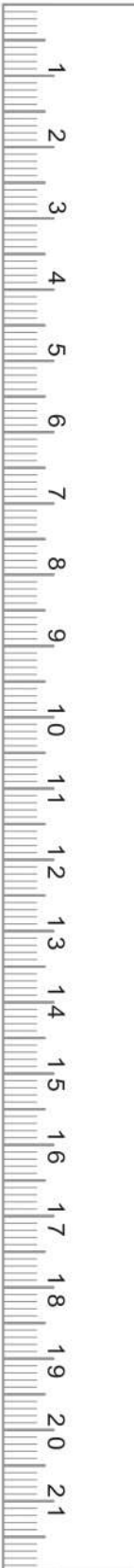

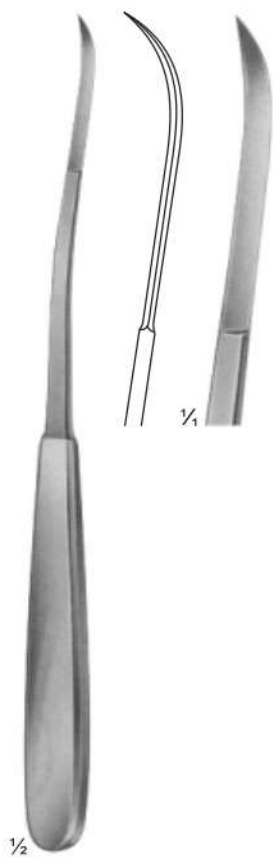

**11-160**  
SALENIUS  
220 mm

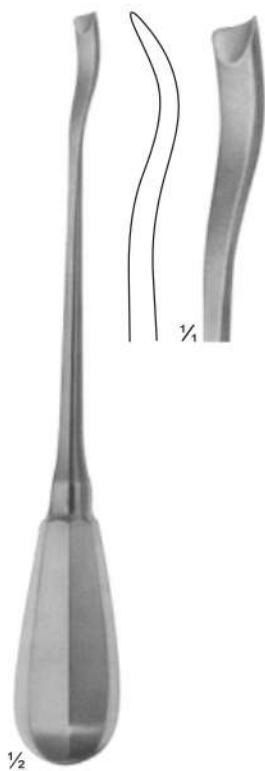

**11-161**  
CHNAD.MODELL  
200 mm

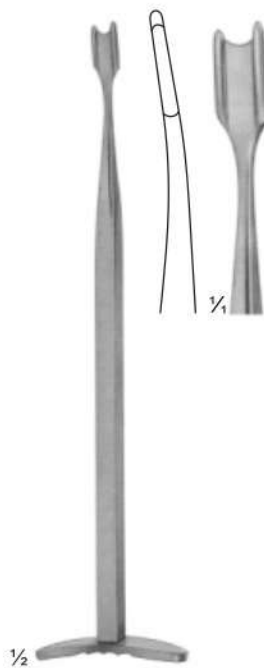

**11-162**  
SMILLIE  
170 mm

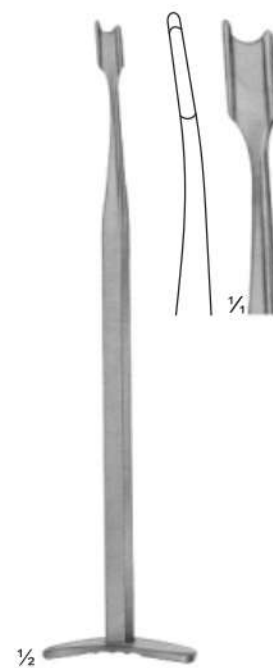

**11-163**  
SMILLIE  
170 mm



Wire Cutters And Wire Cutting Scissors  
Drahtschneider Und Draht Schneidescheren  
Cortadores De Alambre Y Tijeras De Corte De Alambre



**12-101**  
ANGLE  
130 mm

for soft wire  
up to diam.  
for hard wire  
up to diam.

**12-102**  
DUROTIP  
ANGLE  
130 mm

0,5 mm 0,6 mm  
0,3 mm 0,4 mm

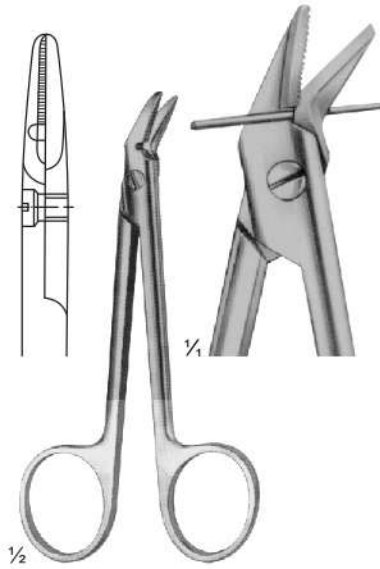

**12-103**  
120 mm

for soft wire  
up to diam.  
for hard wire  
up to diam.

**12-104**  
DUROTIP  
120 mm

1,2 mm 1,2 mm  
0,8 mm 0,8 mm

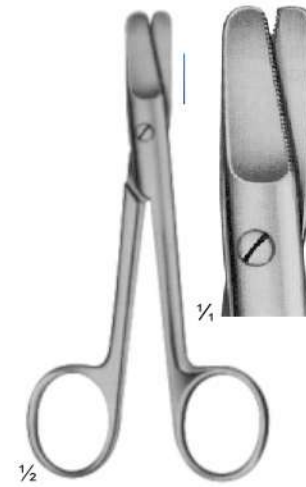

**12-105**  
HARVEY  
125 mm

0,4 mm  
0,3 mm

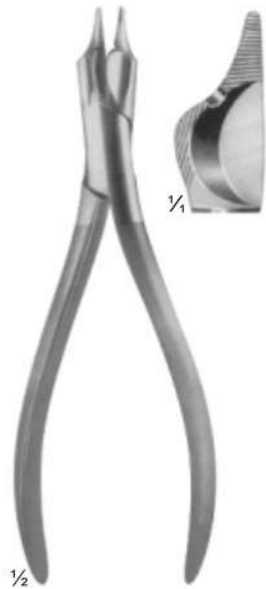

**12-106**  
150 mm

for soft wire  
up to diam  
for hard wire  
up to diam

1,5 mm  
1,0 mm



**12-107**  
160 mm

1,5 mm  
1,2 mm



**12-108**  
140 mm

1,5 mm  
1,0 mm



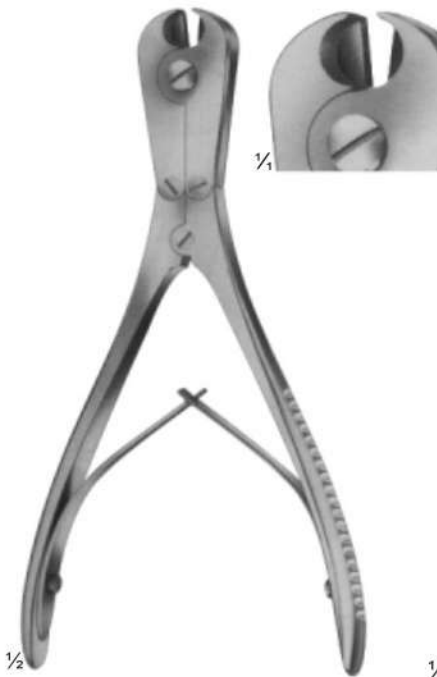
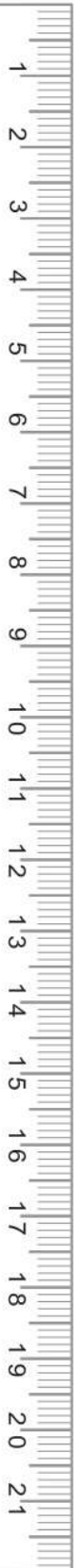

**12-109**  
180 mm

for soft wire  
up to diam. 2,0 mm  
For hard wire 1,5 mm  
up to diam  
specially hardened  
cutting edges, front  
and lateral cutting  
action



**12-110**  
REILL  
175 mm

for soft wire  
up to diam. 2,0 mm  
For hard wire 1,6 mm  
up to diam  
specially hardened  
cutting edges, for  
cutting off wires close  
to the bone



**12-111**  
235 mm

for soft wire  
up to diam. 3,0 mm  
For hard wire 2,2 mm  
up to diam



**12-112**  
STILLE-AESFULAP  
260 mm



**12-113**  
STILLE-AESFULAP  
360 mm

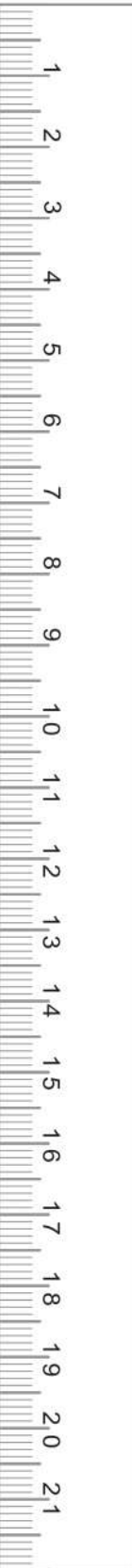



Blade with reinforced back

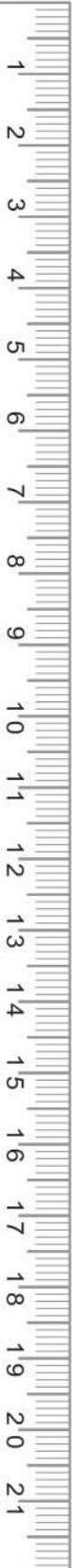

**12-114**  
**STILLE**  
**230 mm**

**12-115**  
 Spare blade



**12-116**  
**STILLE**  
**370 mm**

**12-117**  
 Spare blade



**12-118**  
**STILLE**  
**240 mm**

**12-119**  
 Spare blade



**Vacuum Curettes For Aspiration Lipectomy, Suction Instruments**  
**Vakuum-küretten Für Methode Der Aspirationslipektomie, Saug Instruments**  
**Curetas De Vacío Para Lipectomía De Aspiración, Aspiración Instruments**

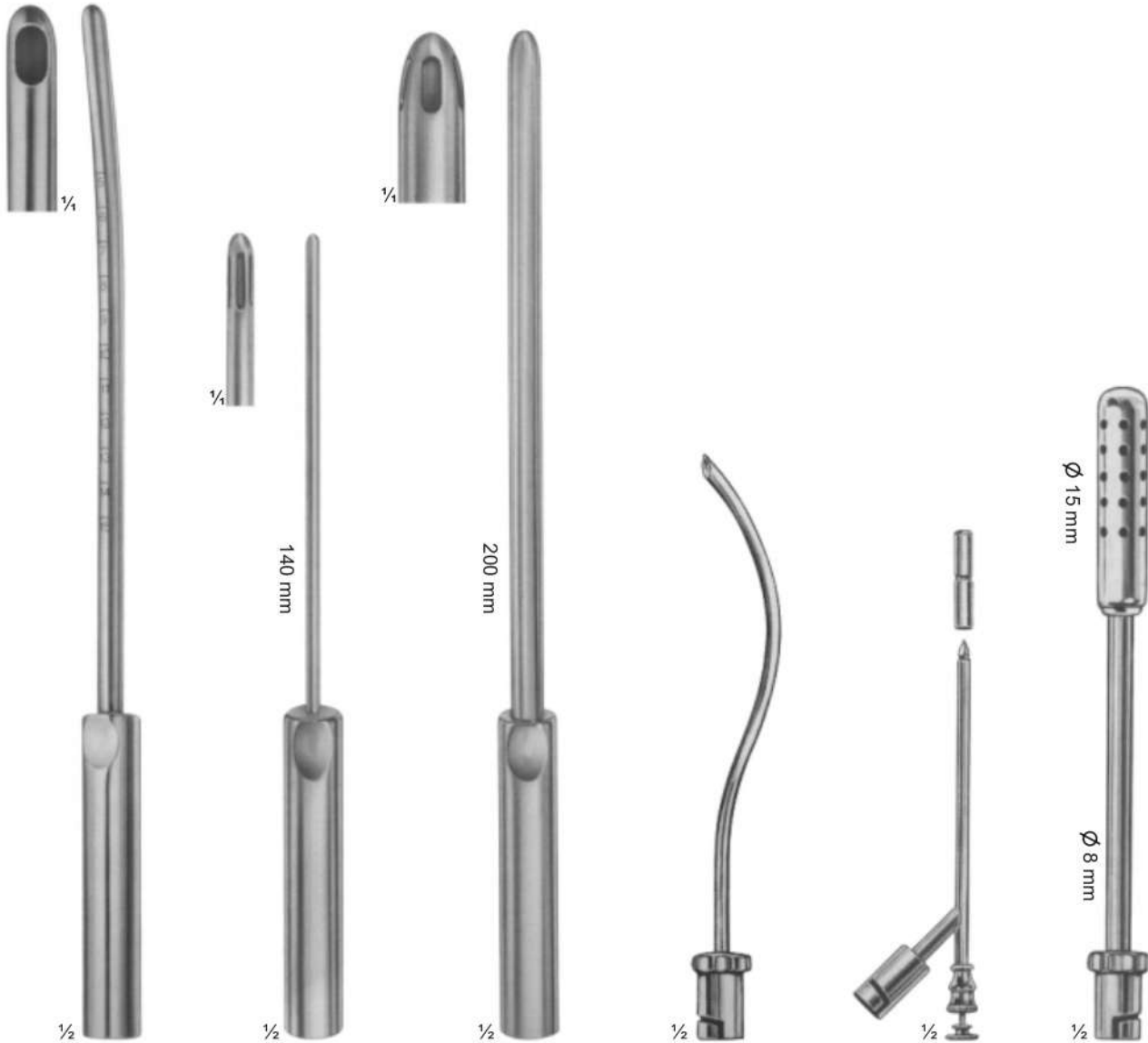

**12-120 - 125**  
BIEMER  
12-120 ø 4 mm  
12-121 ø 6 mm  
12-122 ø 8 mm  
12-123 ø 10 mm  
12-124 ø 12 mm  
12-125 ø 14 mm  
Curettes for aspiration lipectomy, graduated, slightly curved

**12-126 - 128**  
BIEMER  
12-127 ø 4 mm  
12-128 ø 6 mm  
Curettes for aspiration lipectomy, with three apertures, slightly curved malleable

**12-129 - 132**  
BIEMER  
12-130 ø 8 mm  
12-131 ø 10 mm  
12-132 ø 12 mm  
Curettes for aspiration lipectomy, with three apertures, slightly curved malleable

**12-133**  
For aspirating fluid from the excretory ducts of large glands and for keeping the operating area clear 170 mm

**12-134**  
Trocar  
For puncturing 150 mm

**12-135**  
For clearing large quantities of fluid 190 mm

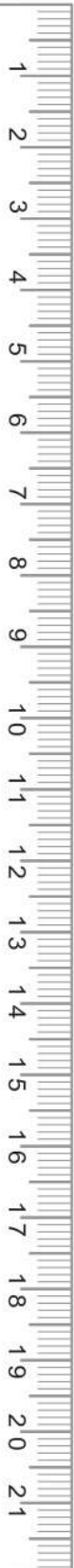

**12-136**  
Trocar  
For puncturing  
170 mm



**12-137**  
Hollow needle,  
sharp  
150 mm



**12-138**  
double curved  
For general  
surgery  
230 mm



**12-139**  
For tonsillectomy,  
oral and laryngeal  
operations  
190 mm



**12-140**  
For tonsillectomy,  
oral and laryngeal  
operations  
220 mm

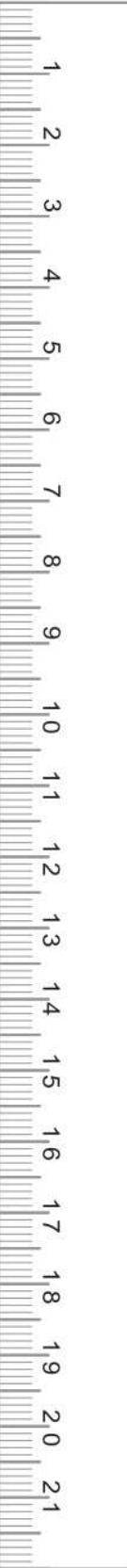
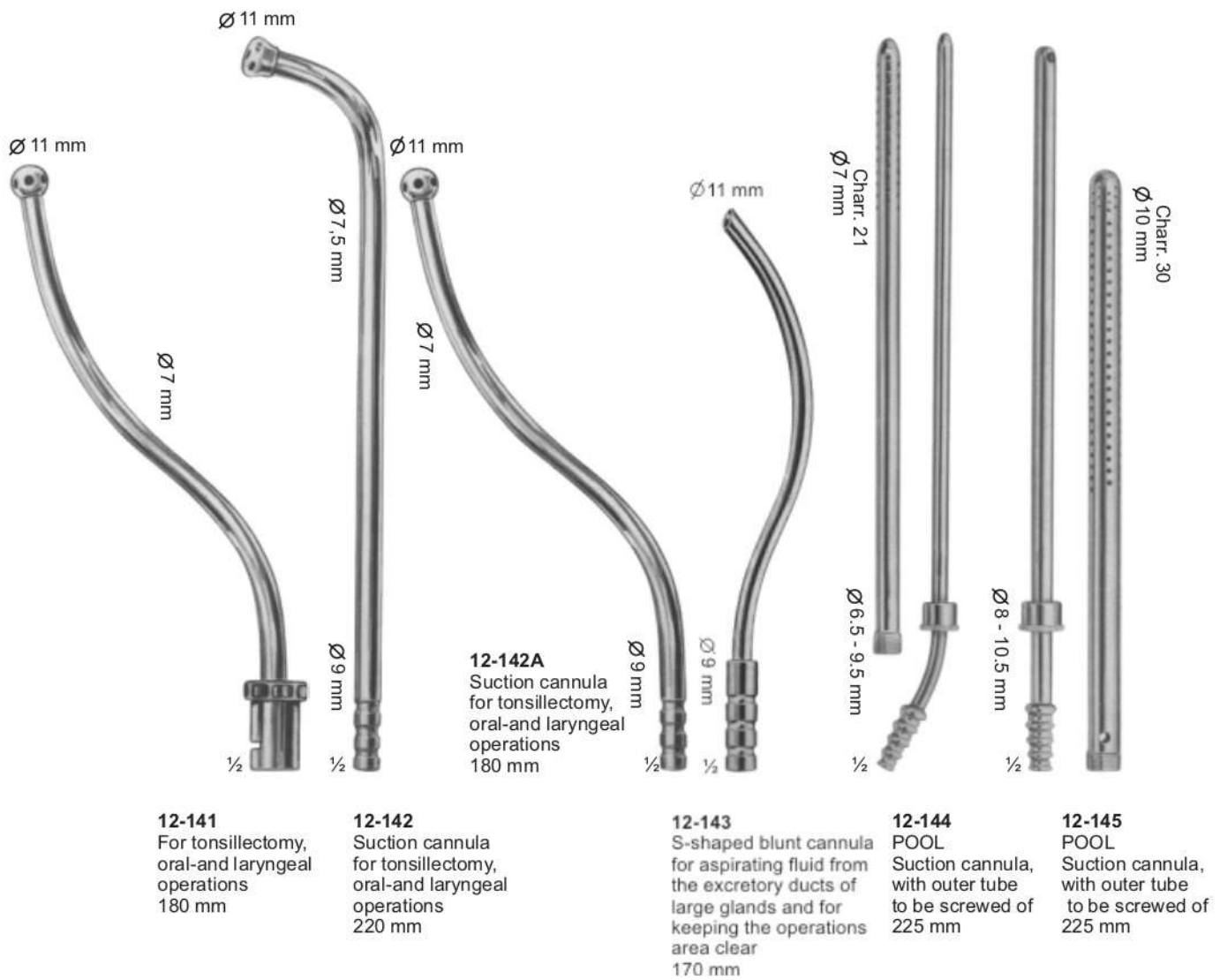

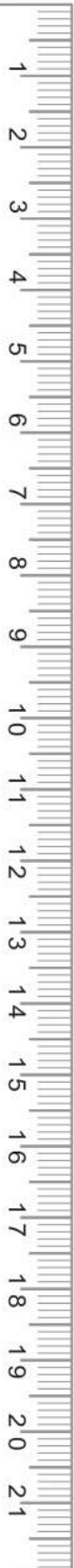

**12-145**  
YANKAUER  
with especially large  
central bore, 4,8 mm  
diam.  
285 mm



**12-147**  
YANKAUER  
with central bore,  
2,0 mm diam.  
285 mm



**12-148**  
DE-BAKEY  
with central bore,  
3,0 mm diam. with  
lateral slots  
275 mm



**12-149**  
DE-BAKEY  
with finger cut-off  
and stylet  
270 mm

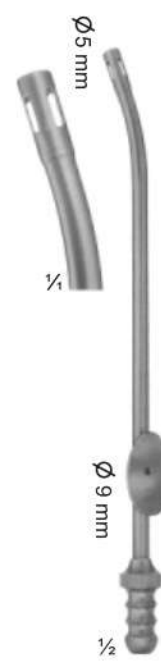

**12-150**  
DE-BAKEY  
with finger cut-off  
and stylet  
160 mm



**12-151**  
with finger  
cut-off  
190 mm

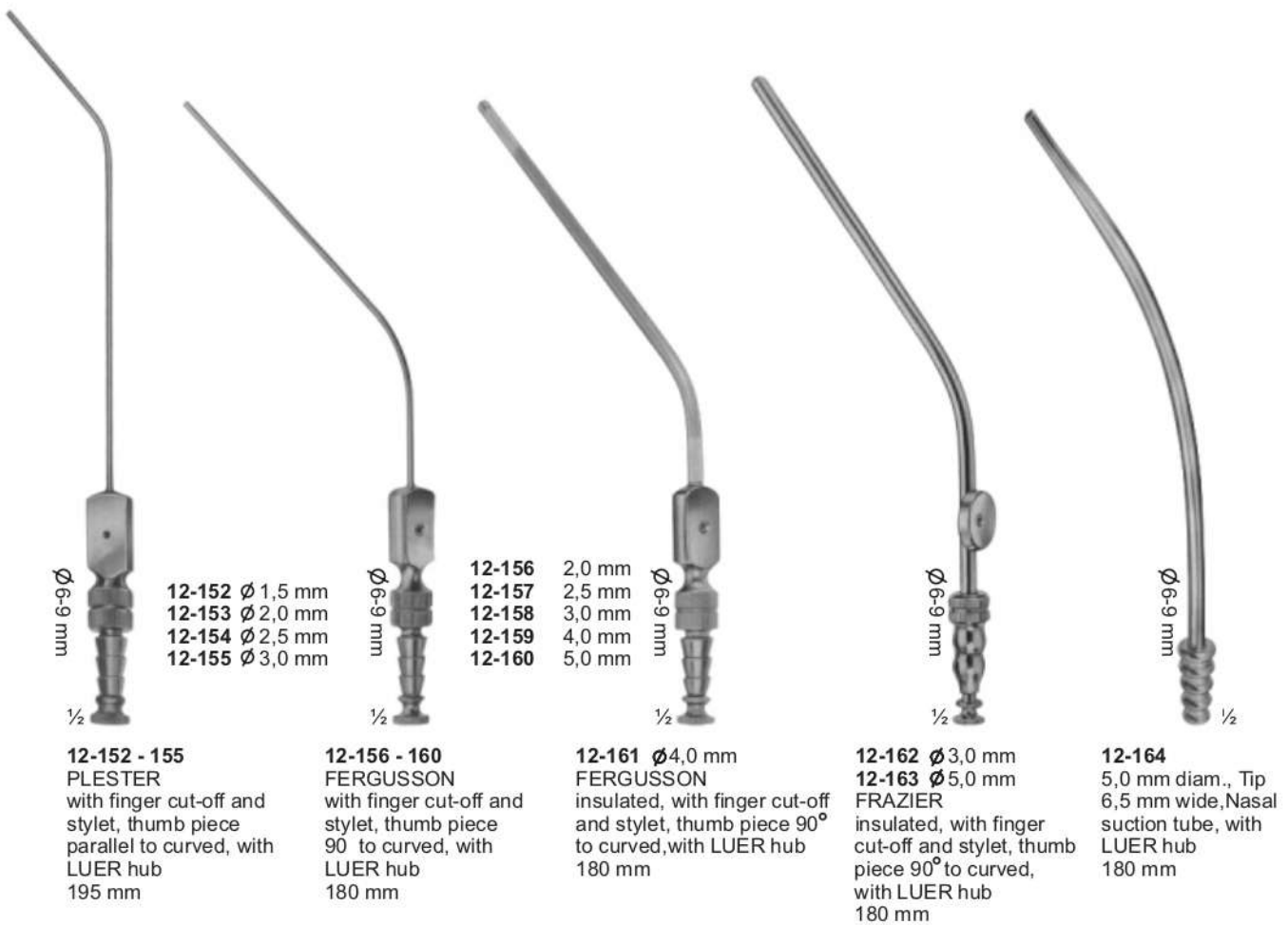

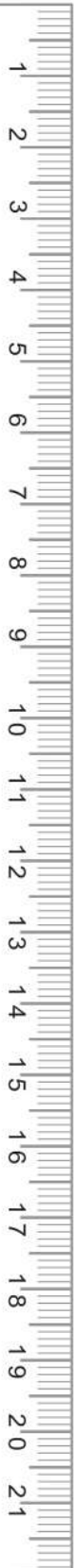

½  
**12-165** ø4,5 mm  
**12-166** ø5,5 mm  
Nasal suction  
tubes  
175 mm

o



½  
**12-167**  
GORNEY  
Suction dissector  
180 mm



Ø6-10 mm

½  
**12-168** 4 mm wide  
**12-169** 5 mm wide  
Suction raspatories,  
sharp, bayonet-shaped,  
with styelt  
200 mm



Ø9 mm

½  
**12-170**  
LOPEZ-REINKE  
Tonsil dissector with  
suction device  
235 mm



**13-101 - 115**  
 Schimmelbusch

	Ø x H sizes in mm
<b>13-101</b>	80 x 80
<b>13-102</b>	105 x 120
<b>13-103</b>	140 x 140
<b>13-104</b>	160 x 120
<b>13-105</b>	160 x 150
<b>13-106</b>	190 x 150
<b>13-107</b>	190 x 190
<b>13-108</b>	240 x 160
<b>13-109</b>	240 x 240
<b>13-110</b>	290 x 160
<b>13-111</b>	290 x 240
<b>13-112</b>	340 x 160
<b>13-113</b>	340 x 340
<b>13-114</b>	390 x 190
<b>13-115</b>	390 x 290



**13-116**  
 Box  
 120 x 65 x 13mm  
 (without Bulldog clamps,  
 without silicone tape)



**13-117**  
 Box with support  
 120 x 65 x 13 mm  
 (ohne Bulldogklemmen)



**13-118**  
 Box with support for  
 needle electrodes,  
 without instruments

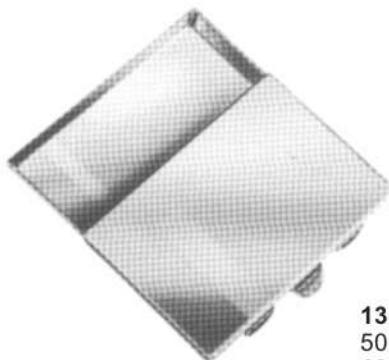

**13-119 - 121**  
 50 x 25 x 4,5 mm  
**13-120**  
 65 x 42 x 8 mm  
**13-121**  
 75 x 25 x 4,5 mm



**13-122**  
 Ø 65mm x 15mm

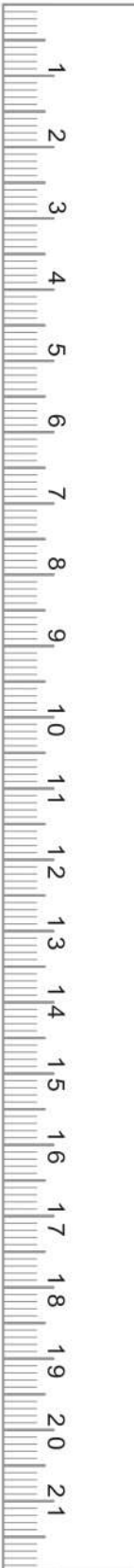



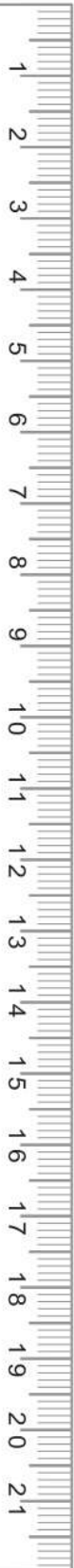

**13-123 - 131**

	Ø x H
<b>13-123</b>	30 x 90 mm
<b>13-124</b>	50 x 100 mm
<b>13-125</b>	50 x 130 mm
<b>13-126</b>	50 x 175 mm
<b>13-127</b>	75 x 100 mm
<b>13-128</b>	75 x 130 mm
<b>13-129</b>	75 x 175 mm
<b>13-130</b>	100 x 175 mm
<b>13-131</b>	100 x 200 mm



**13-132 - 139**

<b>13-132</b>	165 x 85 x 35 mm
<b>13-133</b>	200 x 100 x 35 mm
<b>13-134</b>	200 x 100 x 50 mm
<b>13-135</b>	230 x 130 x 50 mm
<b>13-136</b>	260 x 150 x 50 mm
<b>13-137</b>	270 x 235 x 50 mm
<b>13-138</b>	300 x 200 x 50 mm
<b>13-139</b>	325 x 275 x 50 mm



**13-140**  
205 x 105 x 35 mm



**13-141 - 142**

- 13-141** Martin Sterilizing Forceps  
consisting of:  
1 Sterilizing Forceps, curved, 25 cm,  
without ratchet, with lid for jar  
1 jar with bottom plate (anti-tilt)
- 13-142** ditto, with 32 cm long Sterilizing Forceps



**13-143 - 148**       $\varnothing \times H$

<b>13-143</b>	75 x 60 mm
<b>13-144</b>	75 x 75 mm
<b>13-145</b>	100 x 60 mm
<b>13-146</b>	100 x 100 mm
<b>13-146A</b>	125 x 80 mm
<b>13-147</b>	125 x 125 mm
<b>13-148</b>	150 x 150 mm



**13-149**      **13-150**  
 25 cc              50 cc



**13-151**  
 20 cc  
 Medicine Spoon



**13-152**  
 $\varnothing$  75 x 12 mm  
 Tablet Tray



**13-153**  
 $\varnothing$  90 x 90 mm  
 Metal Cup



**13-154**  
 $\varnothing$  75 x 80 mm  
 Sputum Cup



**Kidney Dish**



**13-155 - 157**

<b>13-155</b>	170 x 100 x 35 mm
<b>13-156</b>	250 x 140 x 40 mm
<b>13-157</b>	275 x 150 x 45 mm



13-158 - 165

Ø x H

13-158	40 x 19	mm	0.05L
13-159	61 x 30	mm	0.07L
13-160	80 x 40	mm	0.14L
13-161	116 x 50	mm	0.35L
13-162	128 x 55	mm	0.45L
13-163	147 x 65	mm	0.70L
13-164	167 x 75	mm	1.10L
13-165	187 x 85	mm	1.60L



13-166 - 170

13-166	116 x 35	mm	0.30L
13-167	128 x 38	mm	0.40L
13-168	147 x 40	mm	0.50L
13-169	157 x 45	mm	0.75L
13-170	187 x 45	mm	1.00L



13-171

Ø 110 x 28 mm 0.15L



13-172

100 cc 0.1L



13-173 - 176

13-173	0,25L
13-174	0,50L
13-175	1,00L
13-176	2,00L



13-177

235 x 190 x 40 mm



13-178

Ø220 x 70 mm

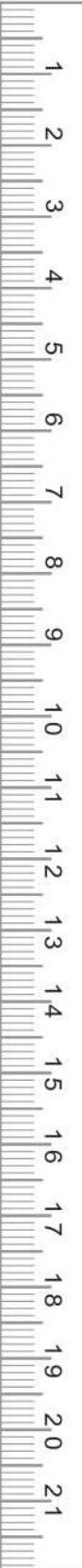

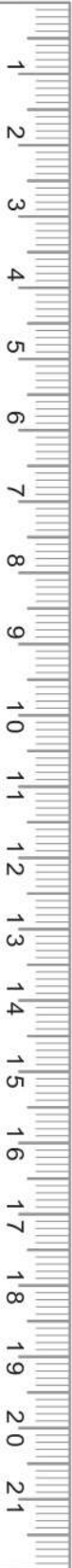

**13-179**  
Ø 50 x 100 mm  
Powder Pot



**13-180**  
50 x 75 mm  
Methot With Lid



**13-181**  
Ø 50 x 75 mm  
Methot Without Lid



**13-182**



**13-183**



**13-184**



**13-185 - 186**

**13-185** Ø235 mm  
**13-186** Ø310 mm



**13-187**  
Sauerbruch  
210 x 125 x 17 mm



**13-188**  
Sauerbruch  
210 x 125 x 17 mm



**13-189**  
150 x 95 x 13 mm



**13-190**  
150 x 95 x 13 mm



**13-191**  
150 x 95 x 13 mm



**13-192**  
150 x 95 x 13 mm



**13-193**  
150 x 95 x 13 mm



**13-194**  
150 x 95 x 13 mm

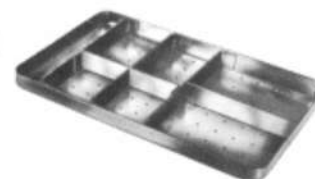

**13-195**  
150 x 95 x 11 mm





**13-196**  
Deponette  
245 x 135 x 35mm



**13-197**  
Deponette  
245 x 135 x 50mm



**13-198**  
Deponette  
245 x 135 x 60mm

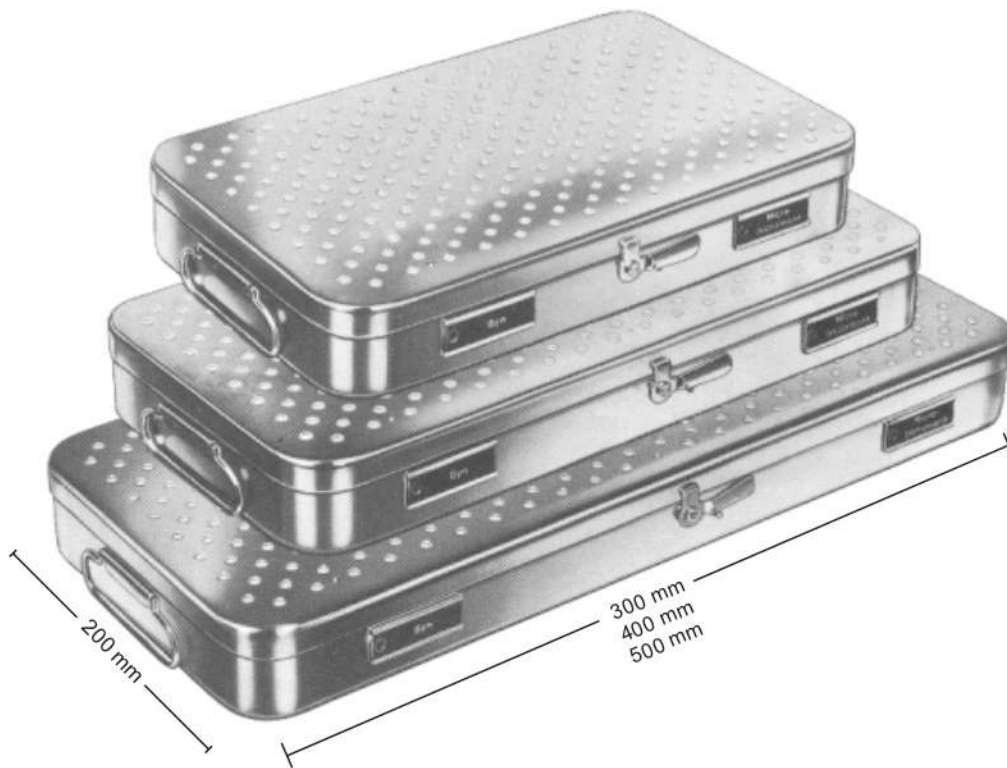

13-199 - 209

<b>13-199</b>	230 x 130 x 50	mm
<b>13-200</b>	260 x 150 x 50	mm
<b>13-201</b>	275 x 235 x 50	mm
<b>13-202</b>	300 x 200 x 50	mm
<b>13-203</b>	325 x 275 x 50	mm
<b>13-204</b>	420 x 175 x 50	mm
<b>13-205</b>	230 x 130 x 75	mm
<b>13-206</b>	260 x 150 x 75	mm
<b>13-207</b>	300 x 200 x 75	mm
<b>13-208</b>	325 x 275 x 75	mm
<b>13-209</b>	420 x 175 x 75	mm





**13-210 - 212**

<b>13-210</b>	480 x 250 x 50	mm
<b>13-211</b>	520 x 250 x 75	mm
<b>13-212</b>	520 x 250 x 100	mm



13-213 - 218

13-213	240 x 240 x 50	mm
13-214	240 x 240 x 80	mm
13-215	240 x 240 x 100	mm
13-216	480 x 260 x 50	mm
13-217	520 x 260 x 80	mm
13-218	520 x 260 x 100	mm

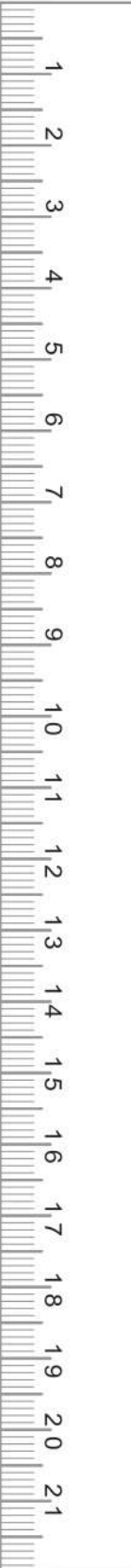

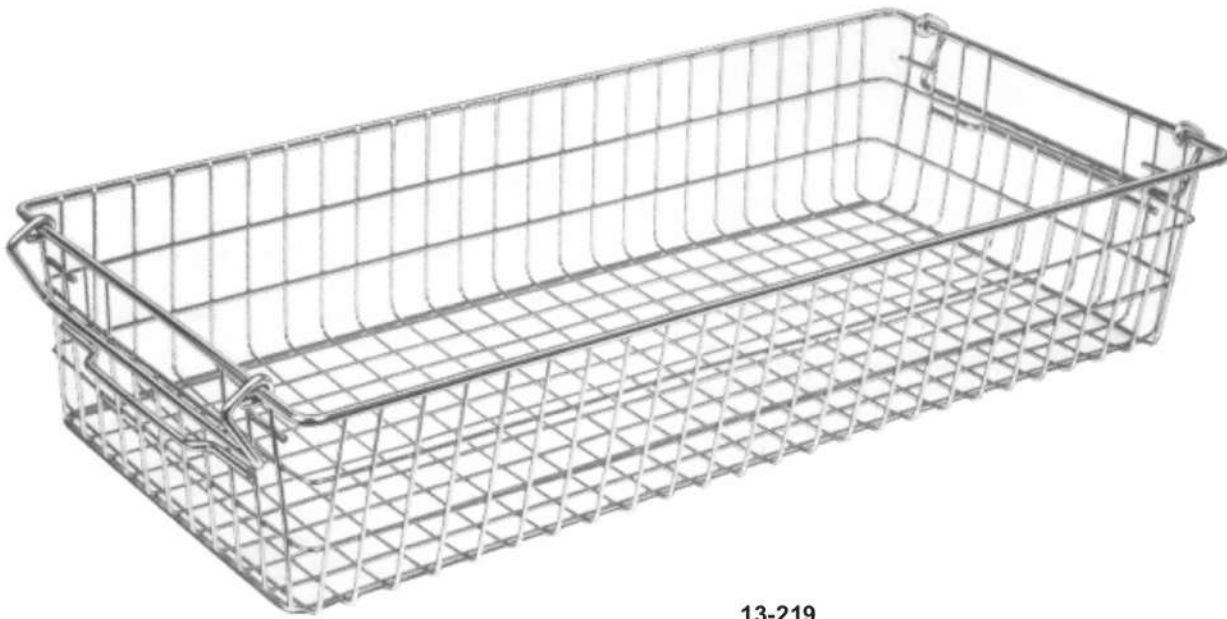
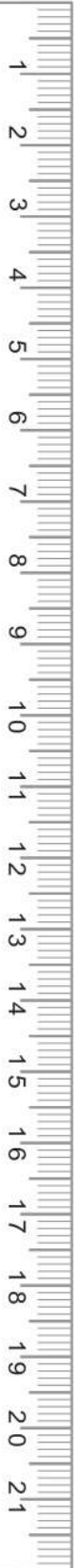

**13-219**  
(60 x 30 x 15 cm)  
Nominal dimensions



Scissors With Tungsten Carbide Inserts  
Scheren Mit Hartmetall-wendeplatten  
Tijeras Con Insertos De Carburo De Tungstenc



STANDARD  
14-101 - 103

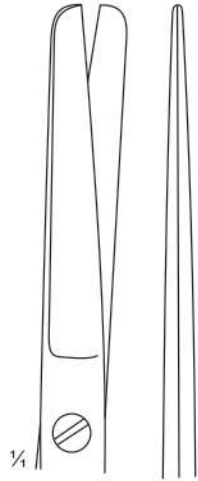

14-101  
145mm

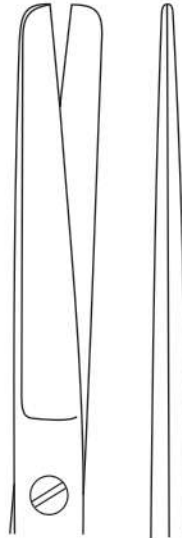

14-102  
165 mm

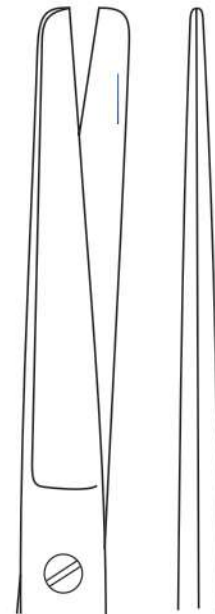

14-103  
185 mm



STANDARD  
14-104 - 106

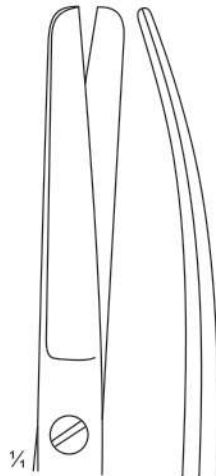

14-104  
145 mm

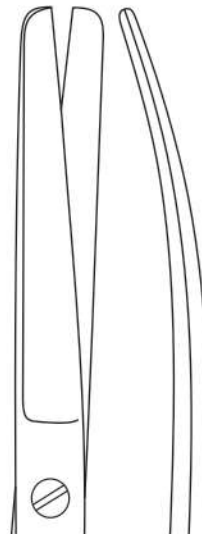

14-105  
165 mm

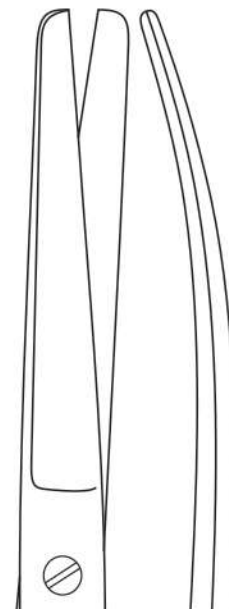

14-106  
185 mm



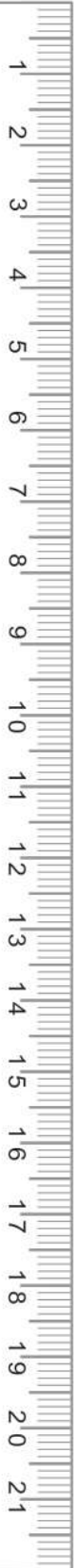

**STANDARD**  
**14-107 - 109**

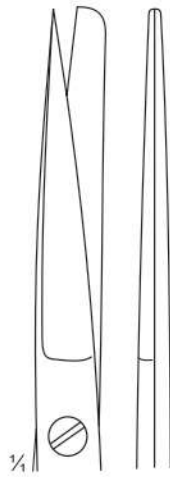

**14-107**  
**145 mm**

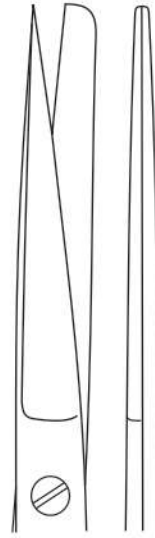

**14-108**  
**165 mm**

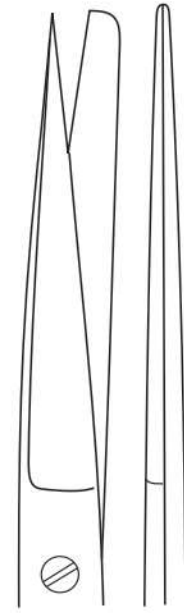

**14-109**  
**185 mm**



**STANDARD**  
**14-110 - 112**

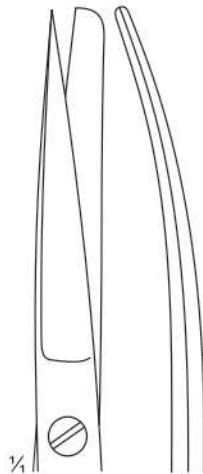

**14-110**  
**145 mm**

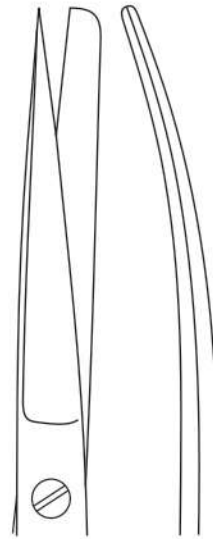

**14-111**  
**165 mm**

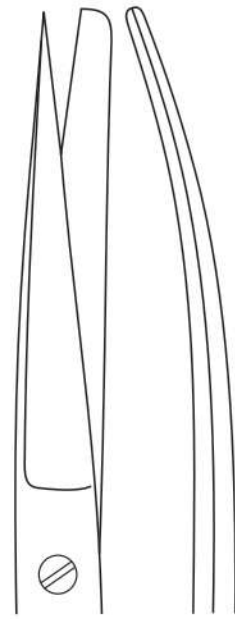

**14-112**  
**185 mm**



**Scissors With Tungsten Carbide Inserts**  
**Scheren Mit Hartmetall-wendeplatten**  
**Tijeras Con Insertos De Carburo De Tungstenc**

**MATU BROTHERS  
SURGICAL**



**STANDARD**  
**14-113 - 115**

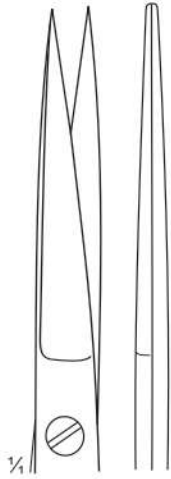

**14-113**  
145 mm

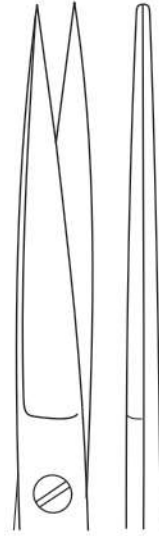

**14-114**  
165 mm

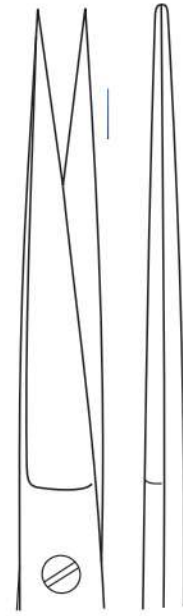

**14-115**  
185 mm



**STANDARD**  
**14-116 - 118**

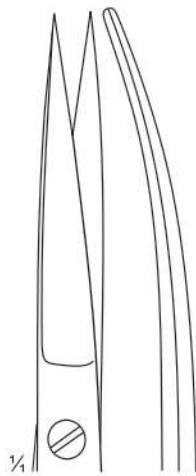

**14-116**  
145 mm

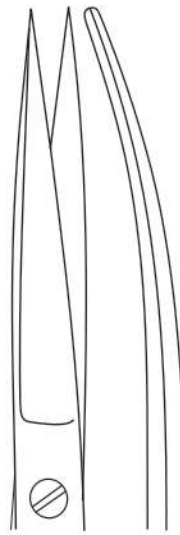

**14-117**  
165 mm

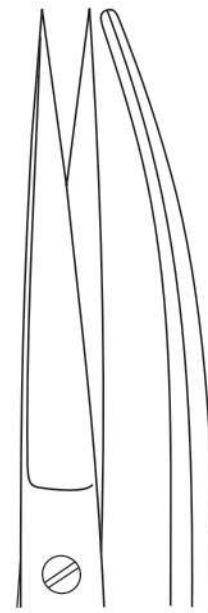

**14-118**  
185 mm





**MAYO  
14-119 - 121**

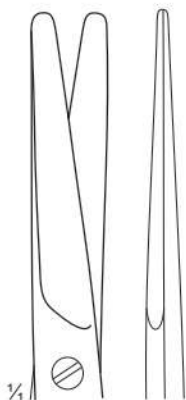

**14-119  
145 mm**

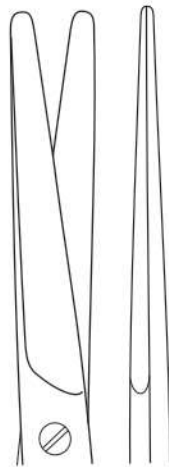

**14-120  
170 mm**

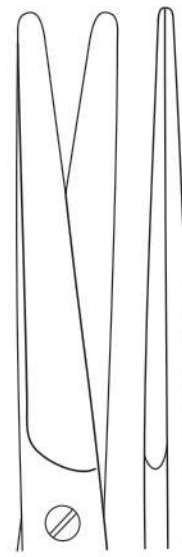

**14-121  
230 mm**



**MAYO  
14-122 - 124**

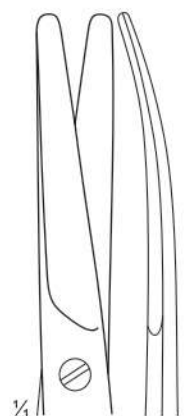

**14-122  
145 mm**

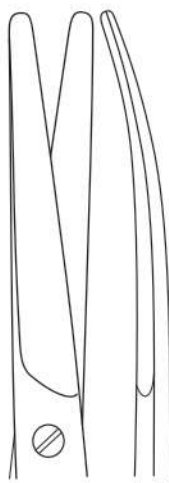

**14-123  
170 mm**

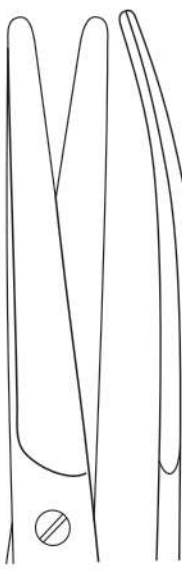

**14-124  
230 mm**

**Scissors With Tungsten Carbide Inserts**  
**Scheren Mit Hartmetall-wendeplatten**  
**Tijeras Con Insertos De Carburo De Tungstenc**



**MAYO**  
**14-125 - 127**

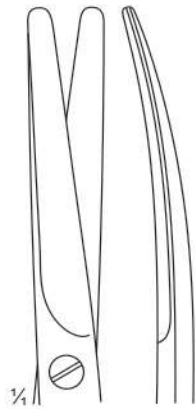

**14-125**  
**140 mm**

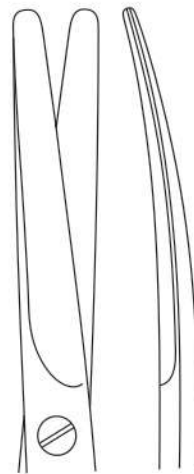

**14-126**  
**170 mm**

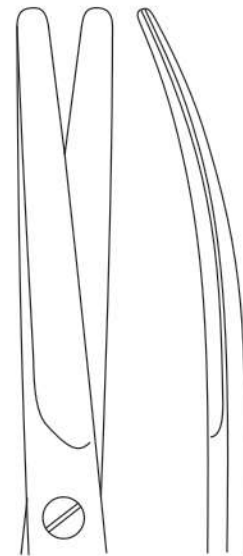

**14-127**  
**230 mm**





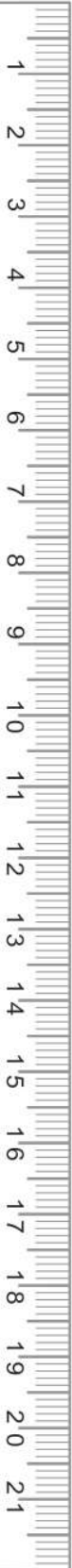

**MAYO-STILLE**  
**14-128 - 129**

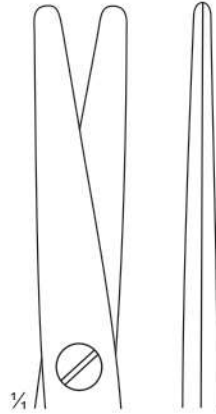

**14-128**  
**150 mm**

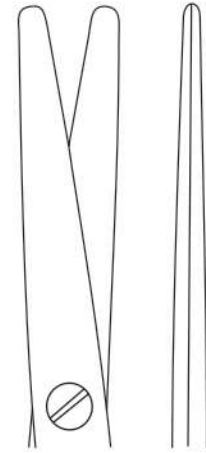

**14-129**  
**170 mm**



**MAYO-STILLE**  
**14-130 - 131**

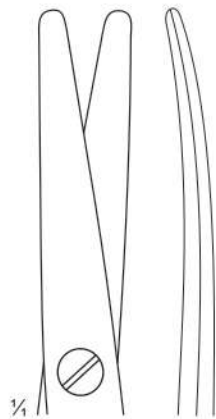

**14-130**  
**150 mm**

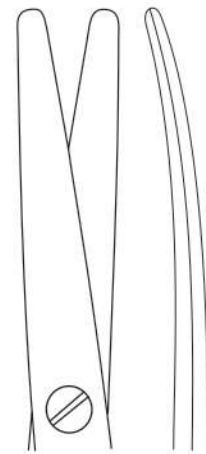

**14-131**  
**170 mm**



**METZENBAUM  
 14-132 - 133**



**14-132  
 115 mm**

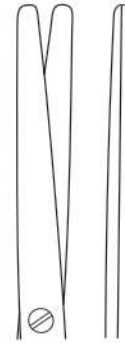

**14-133  
 145 mm**



**METZENBAUM  
 14-134 - 135**

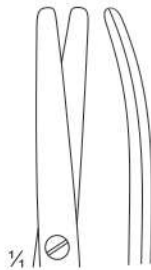

**14-134  
 115 mm**

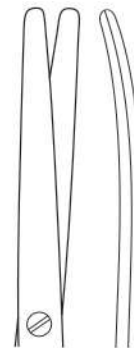

**14-135  
 145 mm**

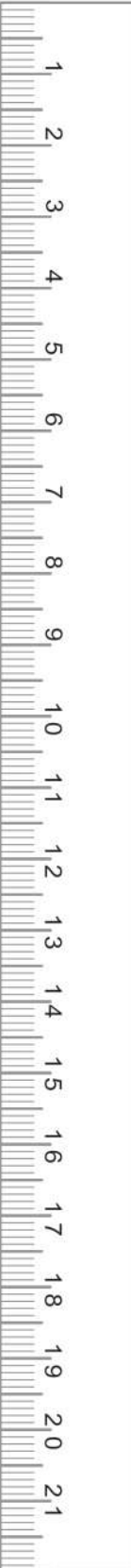



**METZENBAUM  
14-136 - 141**

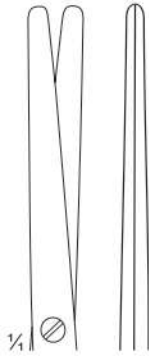

**14-136**  
180 mm

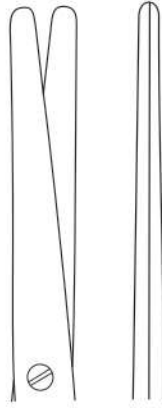

**14-137**  
200 mm

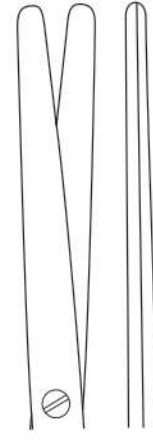

**14-138**  
230 mm

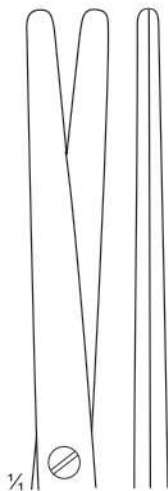

**14-139**  
250 mm

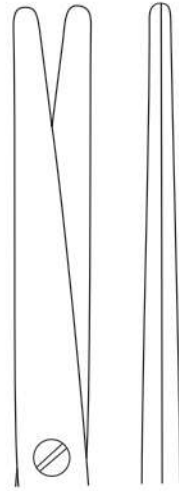

**14-140**  
280 mm

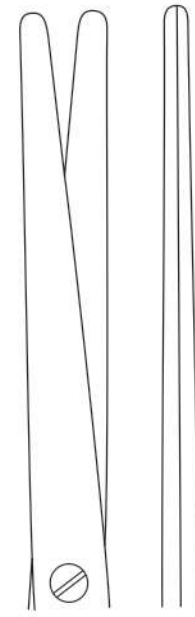

**14-141**  
300 mm

**Scissors With Tungsten Carbide Inserts**  
**Scheren Mit Hartmetall-wendeplatten**  
**Tijeras Con Insertos De Carburo De Tungstenc**



**METZENBAUM**  
**14-142 - 147**

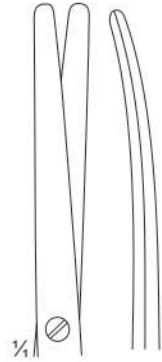

**14-142**  
**180 mm**

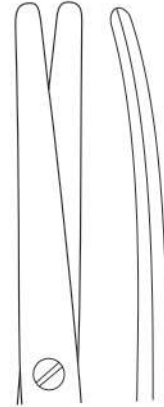

**14-143**  
**200 mm**

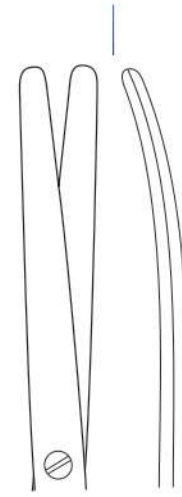

**14-144**  
**230 mm**

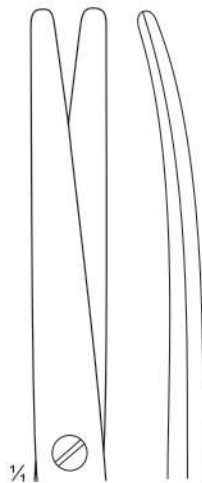

**14-145**  
**250 mm**

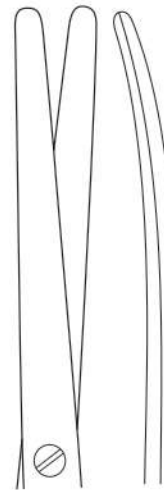

**14-146**  
**280 mm**

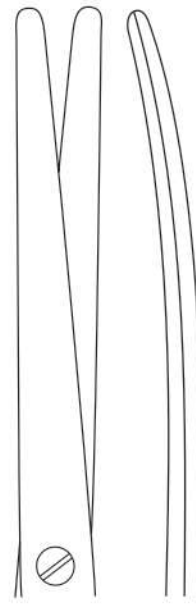

**14-147**  
**300 mm**

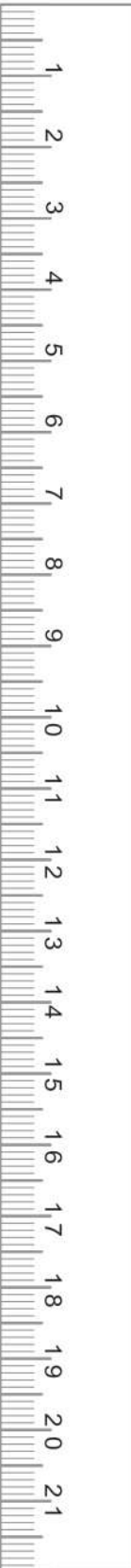

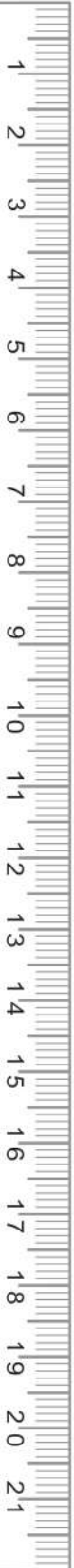

**METZENBAUM-THOREK**  
**14-148 - 150**

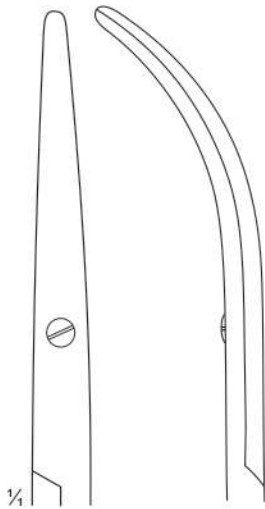

**14-148**  
**200 mm**

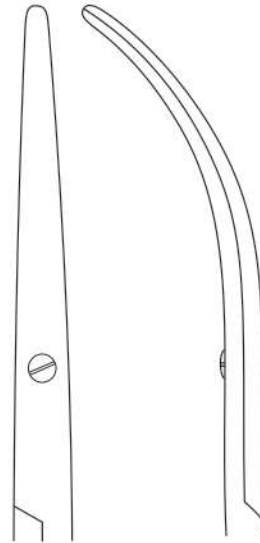

**14-149**  
**230 mm**

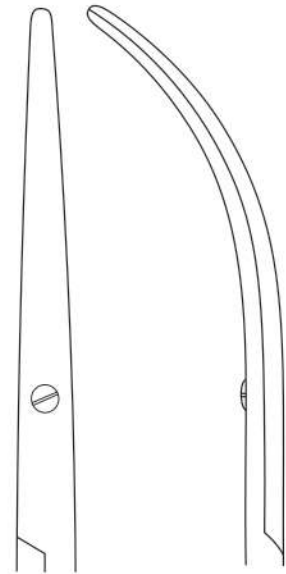

**14-150**  
**280 mm**



**Scissors With Tungsten Carbide Inserts**  
Scheren Mit Hartmetall-wendeplatten  
Tijeras Con Insertos De Carburo De Tungstenc



**METZENBAUM-S**  
**14-151 - 154**

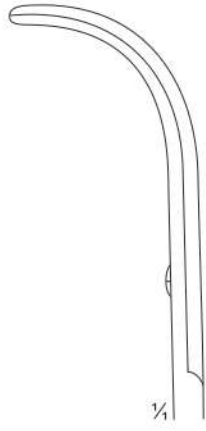
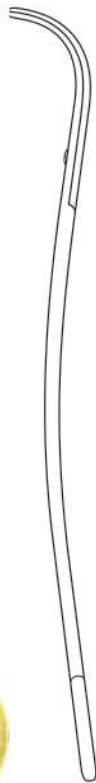

**14-151**  
200 mm

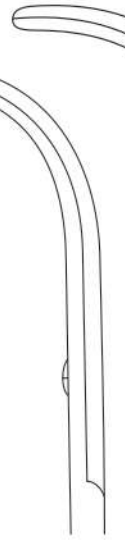

**14-152**  
230 mm

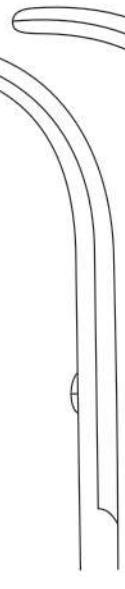

**14-153**  
250 mm

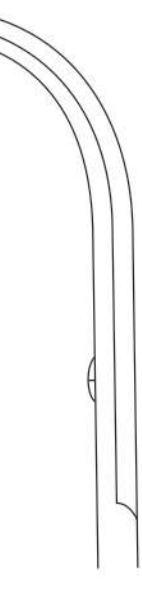

**14-154**  
280 mm





**LEXER**  
**14-155 - 156**

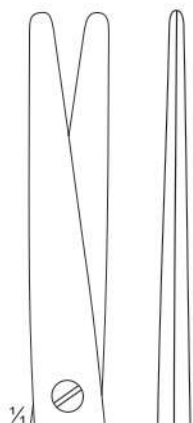

**14-155**  
**160 mm**

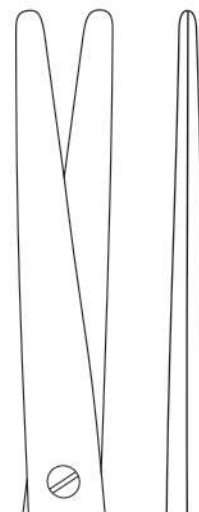

**14-156**  
**210 mm**



**LEXER**  
**14-157 - 158**

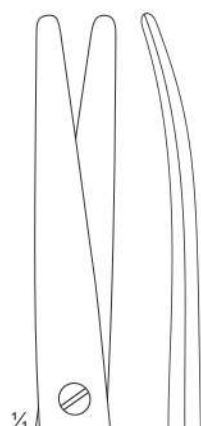

**14-157**  
**160 mm**

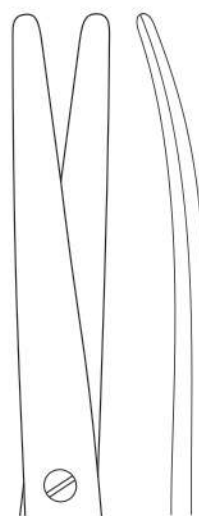

**14-158**  
**210 mm**



MAYO-LEXER  
14-159  
160 mm

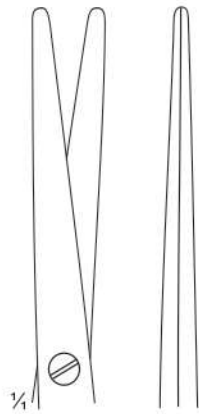

14-159



MAYO-LEXER  
14-160  
160 mm

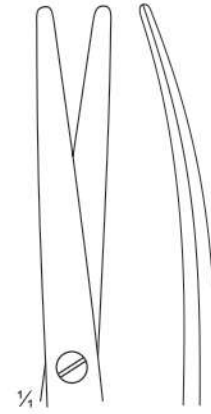

14-160

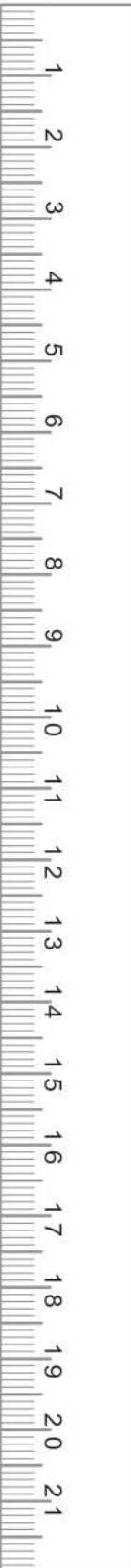



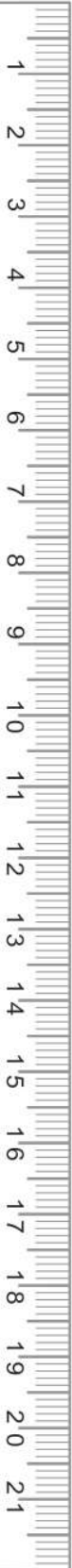

**METZENBAUM-FINO**  
**14-161 - 166**

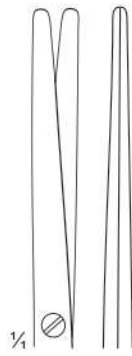

**14-161**  
 140 mm

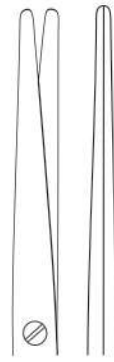

**14-162**  
 180 mm

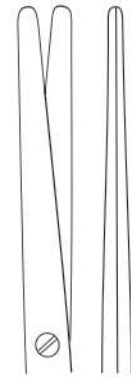

**14-163**  
 200 mm

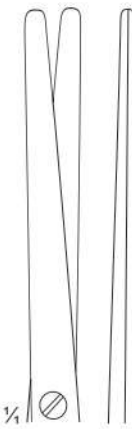

**14-164**  
 230 mm

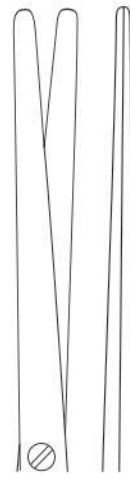

**14-165**  
 250 mm

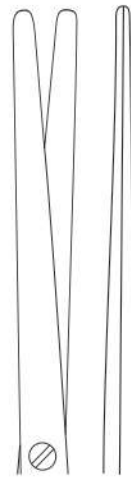

**14-166**  
 280 mm



Scissors With Tungsten Carbide Inserts  
Scheren Mit Hartmetall-wendeplatten  
Tijeras Con Insertos De Carburo De Tungstenc



METZENBAUM-FINO  
14-167 - 172

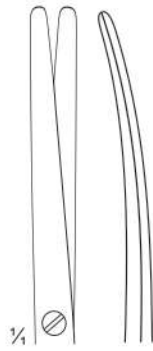

14-167  
140 mm

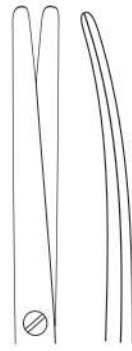

14-168  
180 mm

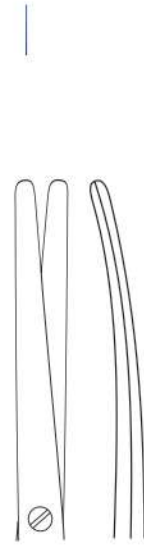

14-169  
200 mm

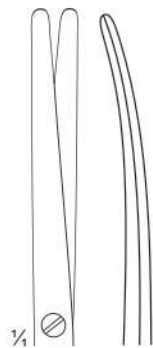

14-170  
230 mm



14-171  
250 mm

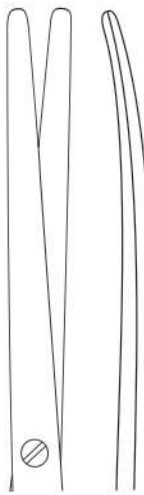

14-172  
280 mm



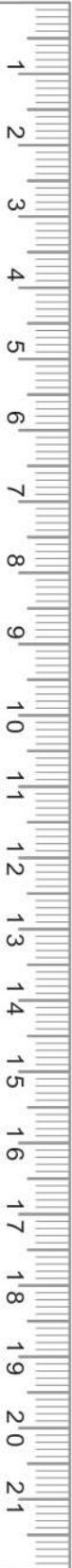

**METZENBAUM-FINO**  
**14-173 - 176**

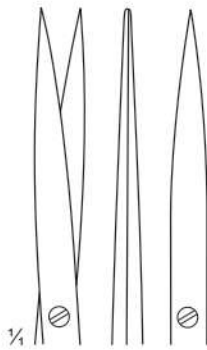

**14-173**  
**140 mm**

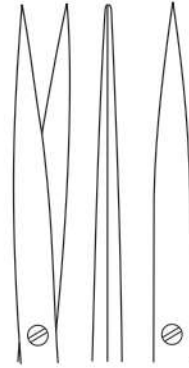

**14-174**  
**180 mm**

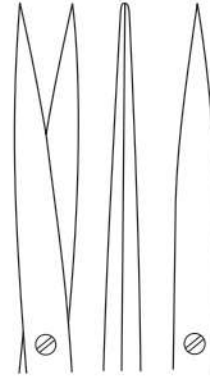

**14-175**  
**200 mm**

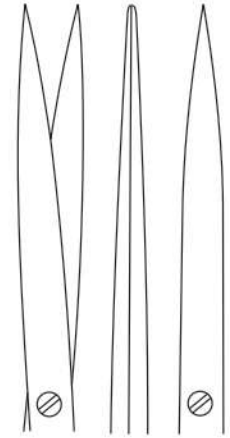

**14-176**  
**230 mm**



**METZENBAUM-FINO**  
**14-177 - 180**

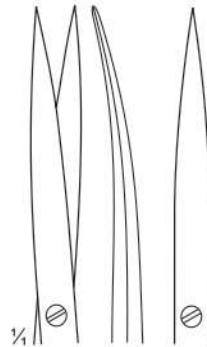

**14-177**  
**140 mm**

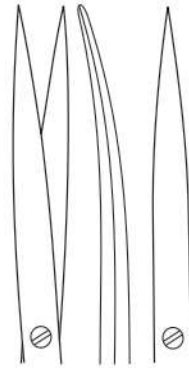

**14-178**  
**180 mm**

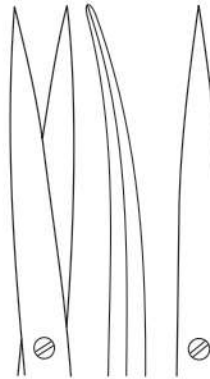

**14-179**  
**200 mm**

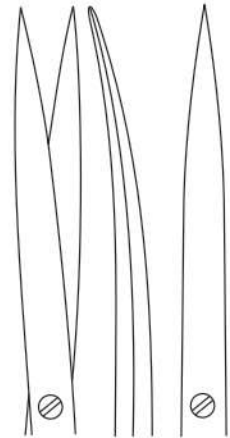

**14-180**  
**230 mm**

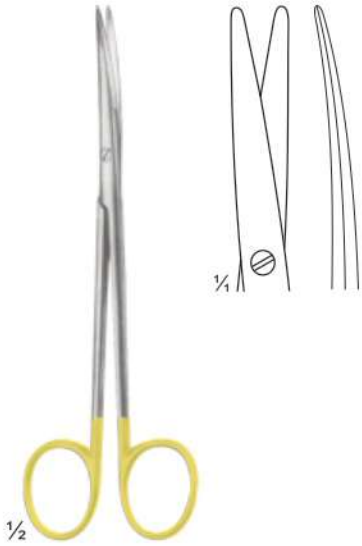

**METZENBAUM-LAHEY**  
**14-181**  
 140 MM



**TOENNIS-ADSON**  
**14-182**  
 170 MM

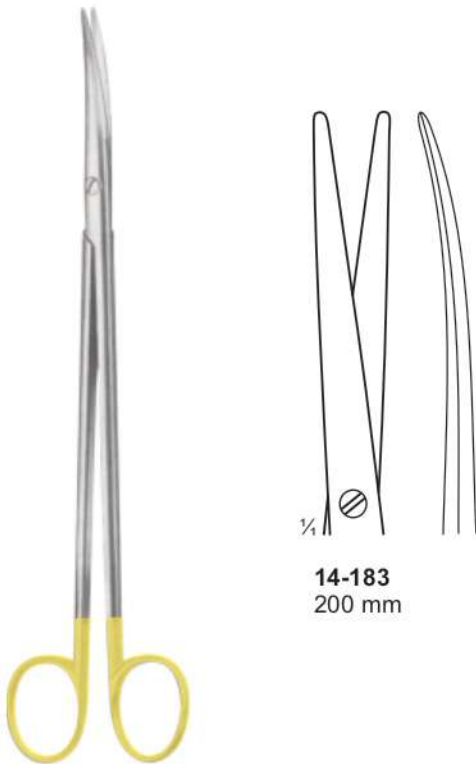

**METZENBAUM**  
**14-183 - 184**

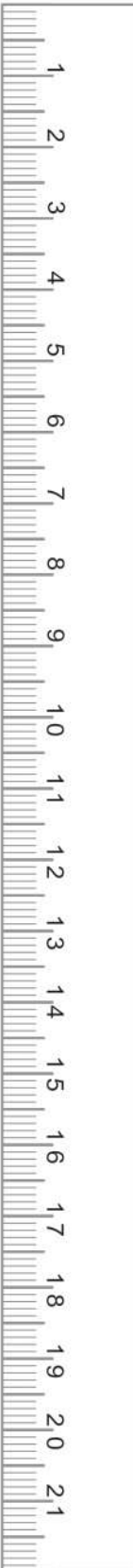
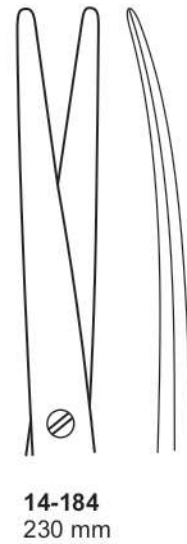
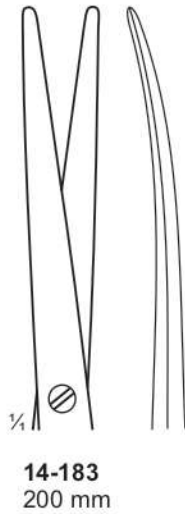

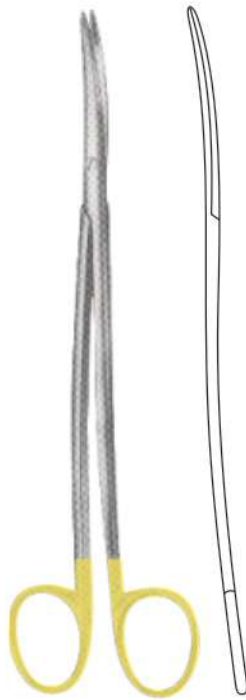
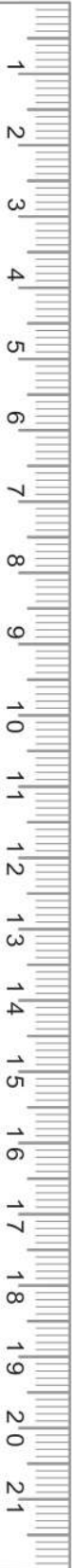

**METZENBAUM-FINO**  
**14-185 - 187**  
 S-förmig gebogen  
 S-shaped  
 curvas en S

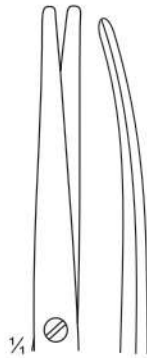

**14-185**  
 180 mm

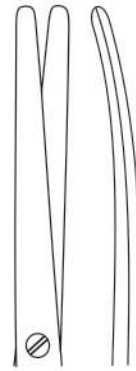

**14-186**  
 200 mm



**14-187**  
 230 mm

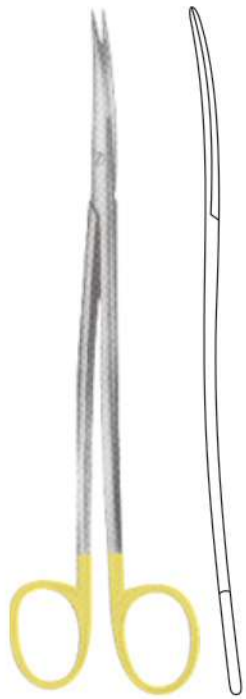

**METZENBAUM-FINO**  
**14-188 - 190**  
 S-förmig gebogen  
 S-shaped  
 curvas en S



**14-188**  
 180 mm

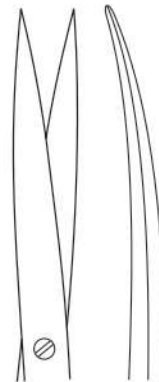

**14-189**  
 200 mm

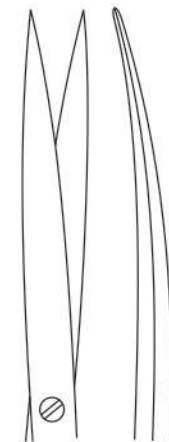

**14-190**  
 230 mm

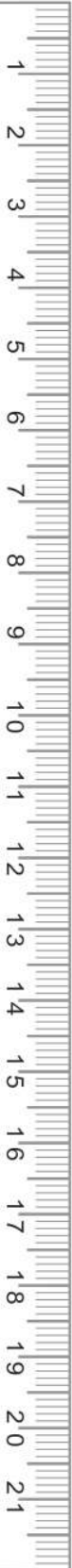

Mikroprofile  
Micro Profile  
Profile Micro

**POTTS-SMITH  
15-101  
220 mm**



Glatt  
Smooth  
Lisas

**HEPP-SCHIEDEL  
15-102  
180 mm**



**15-103  
130 mm**



**15-104  
150 mm**

Miniprofile  
Mini Profile  
Profile Mini

**15-103 - 104**



**MARTIN-VASCULAR**  
**15-105 -108**  
 180 mm



**15-105**  
 Mit Sperre  
 With Lock  
 Con Cierre



**15-106**  
 Mit Sperre  
 With Lock  
 Con Cierre



**15-107**  
 Ohne Sperre  
 Without Lock  
 Sin Cierre



**15-108**  
 Ohne Sperre  
 Without Lock  
 Sin Cierre

Mikroprofile  
 Micro Profile  
 Profile Micro



**DIETRICH**  
**15-109 - 113**



**15-109**  
 160 mm



**15-110**  
 180 mm



**15-111**  
 200 mm



**15-112**  
 230 mm



**15-113**  
 260 mm

Mikroprofile  
 Micro Profile  
 Profile Micro

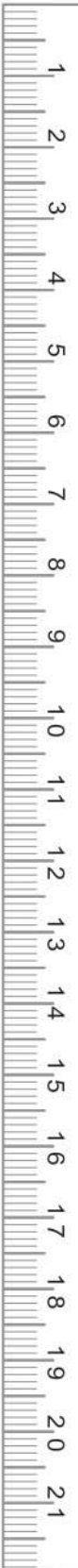

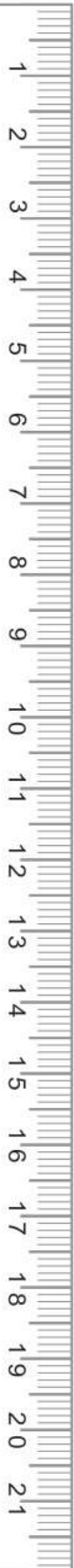

**CASTROVIEJO  
15-114 - 119**



**15-114  
140 mm**

Glatt  
Smooth  
Lisas



**15-117  
140 mm**

Glatt  
Smooth  
Lisas



**15-115  
180 mm**

Mikroprofile  
Micro Profile  
Profile Micro



**15-118  
180 mm**

Mikroprofile  
Micro Profile  
Profile Micro



**15-116  
210 mm**

Mikroprofile  
Micro Profile  
Profile Micro



**15-119  
210 mm**

Mikroprofile  
Micro Profile  
Profile Micro



**ARRUGA  
15-120 -121  
160 mm**



**15-120**

Miniprofile  
Mini Profile  
Profile Mini



**15-121**



**CASTROVIEJO  
15-122  
130 mm**



Glatt  
Smooth  
Lisas



**BARRAQUER  
15-123  
130 mm**



Glatt  
Smooth  
Lisas



**BARRAQUER  
15-124  
130 mm**



Glatt  
Smooth  
Lisas





$\frac{1}{4}$   
 Glatt  
 Smooth  
 Lisas

**WEBSTER**  
**15-125**  
 13 cm / 5"



$\frac{1}{4}$   
 Miniprofile  
 Mini Profile  
 Profile Mini

**DERF**  
**15-126**  
 12 cm / 4 3/4"



$\frac{1}{4}$   
**15-127**  
 13 cm / 5"  
 Miniprofile  
 Mini Profile  
 Profile Mini

$\frac{1}{4}$   
**15-128**  
 14 cm / 5 1/2"

**HEGAR-BAUMGARTNER**  
**15-127 - 128**



$\frac{1}{4}$   
**15-129**  
 Glatt  
 Smooth  
 Lisas

**HALSEY**  
**15-129 - 130**  
 13 cmCM / 5"

$\frac{1}{4}$   
**15-130**  
 Miniprofile  
 Mini Profile  
 Profile Mini



$\frac{1}{4}$   
 Glatt  
 Smooth  
 Lisas

**WEBSTER**  
**15-131**  
 12 cm / 4 3/4"



$\frac{1}{4}$   
 Miniprofile  
 Mini Profile  
 Profile Mini

**CRILE-WOOD**  
**15-132**  
 15 cm / 6"

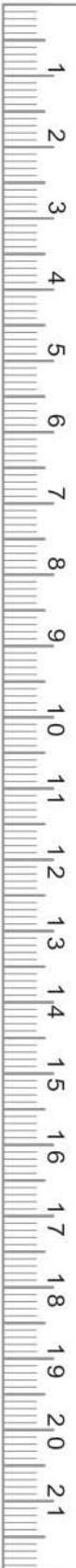

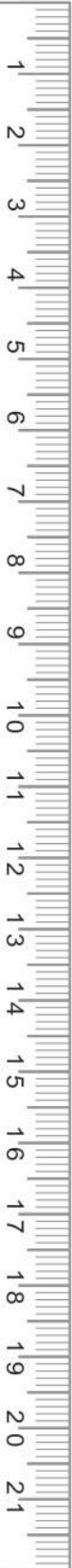

**SAROT  
15-133 - 135**



**15-133**  
18 cm / 7"



**15-134**  
20 cm / 8"



**15-135**  
26 cm / 10 1/4"

Normalprofile  
Normal Profile  
Profile Normal

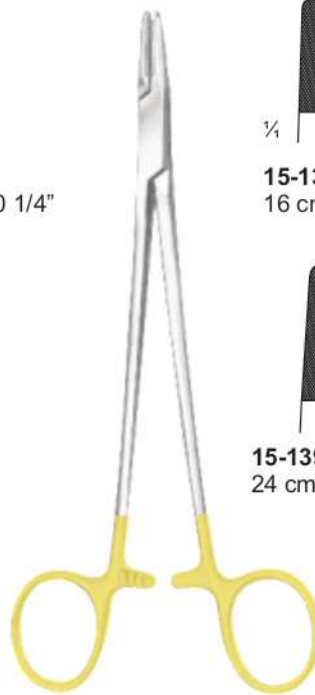

**MAYO-HEGAR  
15-136 - 141**



**15-136**  
16 cm / 6 1/4"



**15-137**  
18 cm / 7"



**15-138**  
20 cm / 8"



**15-139**  
24 cm / 9 1/2"



**15-140**  
26 cm / 10 1/4"



**15-141**  
30 cm / 12"

Normalprofile  
Normal Profile  
Profile Normal



**MAYO-HEGAR (HEANEY)  
15-142 - 144**



**15-142**  
20 cm / 8"



**15-143**  
24 cm / 9 1/2"



**15-144**  
26 cm / 9 1/4"

Normalprofile  
Normal Profile  
Profile Normal



**DE BAKEY  
15-145 - 150**



**15-145**  
18 cm / 7"



**15-146**  
20 cm / 8"



**15-147**  
23 cm / 9"



**15-148**  
26 cm / 10 1/4"



**15-149**  
31 cm / 12 1/4"



**15-150**  
37 cm / 14 1/2"

Miniprofile  
Mini Profile  
Profile Mini



1/2

**MARSSON**  
**15-151**  
 270 mm



1/4

Normalprofile  
 Normal Profile  
 Profile Normal

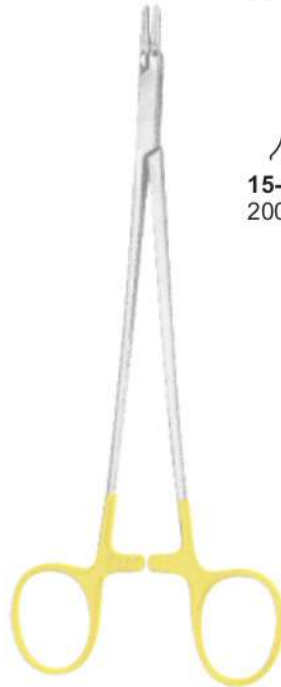

**RYDER (MARTIN)**  
**15-152 - 157**



1/4

**15-152**  
 130 mm



**15-153**  
 150 mm



**15-154**  
 180 mm



**15-155**  
 200 mm



**15-156**  
 230 mm



1/4

**15-157**  
 260 mm

Miniprofile  
 Mini Profile  
 Profile Mini



**15-158**  
 150 mm



**15-159**  
 170 mm



**15-160**  
 200 mm

Miniprofile  
 Mini Profile  
 Profile Mini

**MARTIN**  
**15-158 - 160**

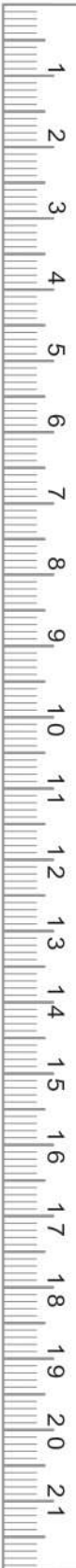

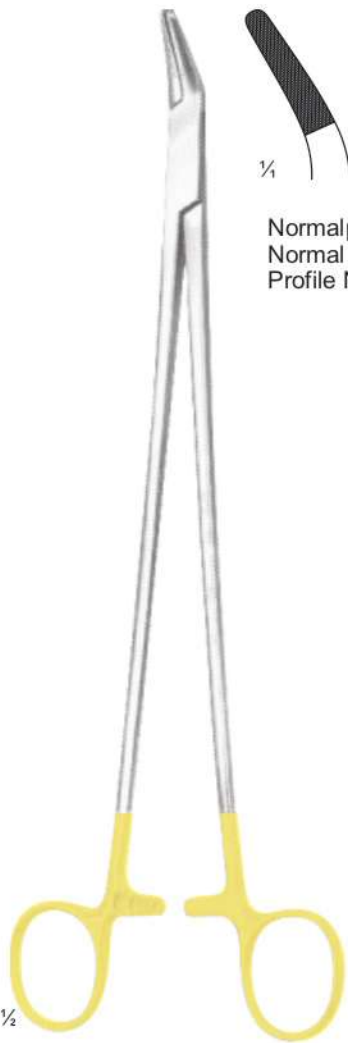
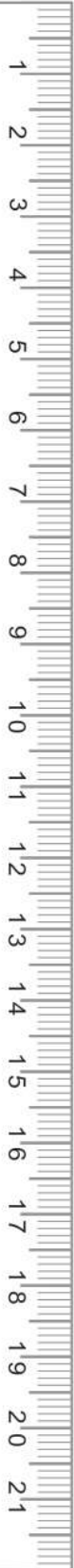

**FINOCCHIETTO  
15-161  
270 mm**

1/4  
Normalprofile  
Normal Profile  
Profile Normal

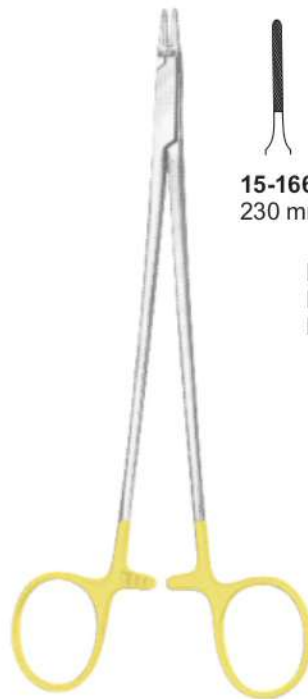

**RYDER-VASCULAR  
15-162 - 167**

1/4  
**15-162**  
130 mm

1/4  
**15-163**  
150 mm

1/4  
**15-164**  
180 mm

1/4  
**15-165**  
200 mm

1/4  
**15-166**  
230 mm

1/4  
**15-167**  
260 mm

Mikroprofile  
Micro Profile  
Profile Micro



**WANGENSTEEN  
15-168  
270 mm**

1/4  
Normalprofile  
Normal Profile  
Profile Normal

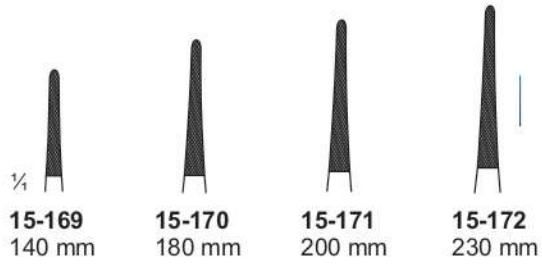

Mikroprofile  
 Micro Profile  
 Profile Micro

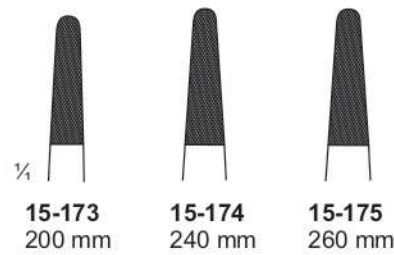
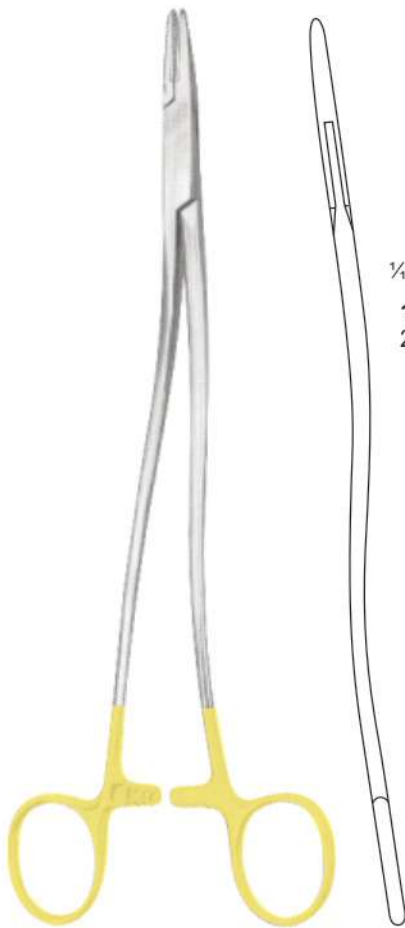

Normalprofile  
 Normal Profile  
 Profile Normal

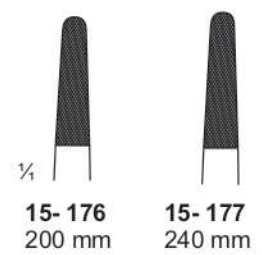

Normalprofile  
 Normal Profile  
 Profile Normal

**BOZEMANN**  
**15-173 - 175**

**HEGAR**  
**15-176 - 177**

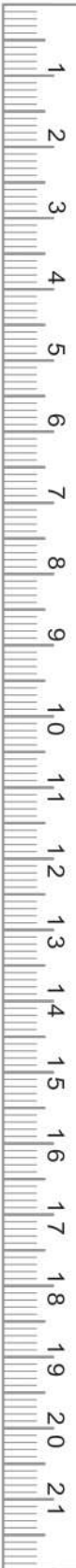

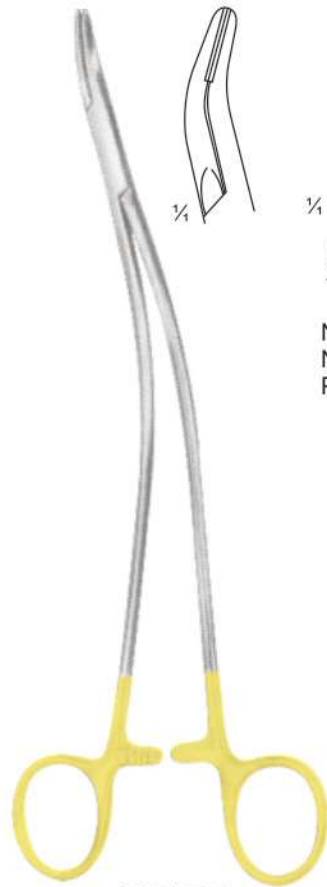
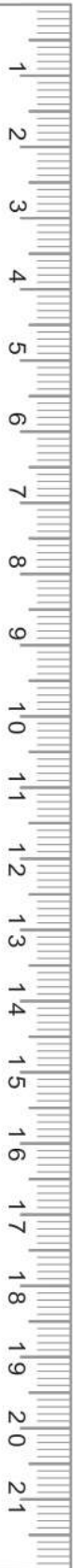

¼

¼

**15-178**  
220 mm

**15-179**  
230 mm

Normalprofile  
Normal Profile  
Profile Normal

**STRATTE**  
**15-178 - 179**



¼

**15-180**  
140 mm



**15-181**  
165 mm



**15-182**  
180 mm

Normalprofile  
Normal Profile  
Profile Normal

**OLSEN-HEGAR**  
**15-180 - 182**

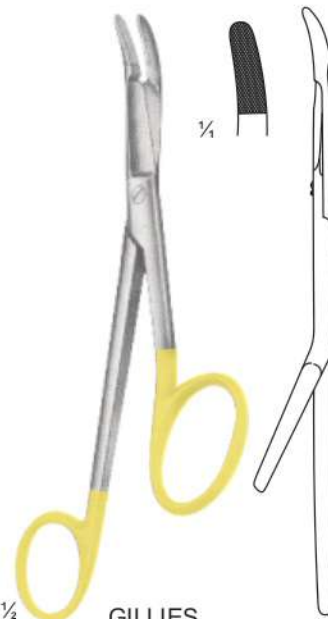

¼

¼

**GILLIES**  
**15-183**  
160 mm

Normalprofile  
Normal Profile  
Profile Normal



**MATHIEU-KOCHER**  
**15-184 - 186**

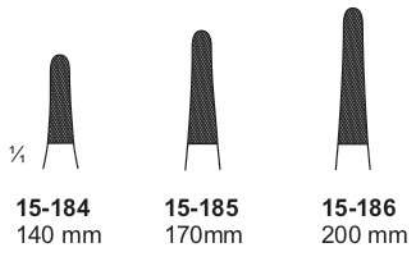

**15-184**  
 140 mm

**15-185**  
 170mm

**15-186**  
 200 mm

Normalprofile  
 Normal Profile  
 Profile Normal



**MATHIEU**  
**15-187-189**

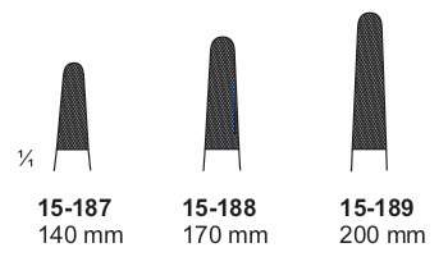

**15-187**  
 140 mm

**15-188**  
 170 mm

**15-189**  
 200 mm

Normalprofile  
 Normal Profile  
 Profile Normal



**MATHIEU**  
**15-190 - 192**

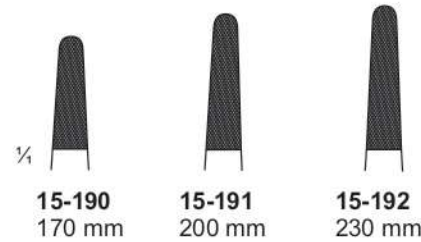

**15-190**  
 170 mm

**15-191**  
 200 mm

**15-192**  
 230 mm

Normalprofile  
 Normal Profile  
 Profile Normal

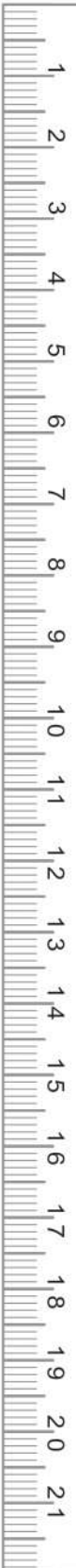

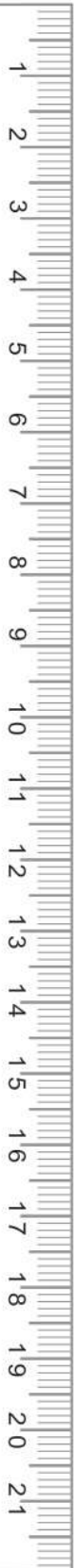

Normalprofile  
Normal Profile  
Profile Normal

**TOENNIS**  
**15-193**  
180 MM



Normalprofile  
Normal Profile  
Profile Normal

**LICHTENBERG**  
**15-194**  
200 MM

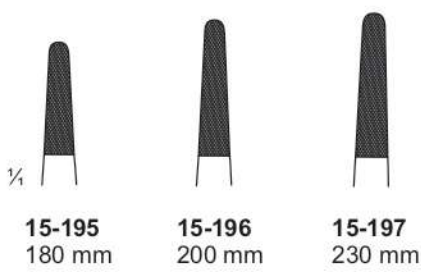

**15-195**  
180 mm

**15-196**  
200 mm

**15-197**  
230 mm

Normalprofile  
Normal Profile  
Profile Normal

**LANGENBECK**  
**15-195 -197**

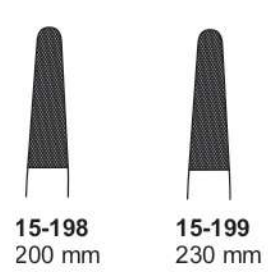

**15-198**  
200 mm

**15-199**  
230 mm

Normalprofile  
Normal Profile  
Profile Normal

**ZWEIFEL**  
**15-198 -199**



<b>A</b>		Baby Mikulicz Forceps	78
		Baby Mixer Forceps	74
Abdominal Retractors	120-121	Baby Mosquito Forceps	67
Abdominal Retractors	133-137	Baby Overholt Forceps	74
Abdominal Spatulas	123-124	Baby- Roux Retractors	105
Abraham Tonsil Knife	13	Baby- Senn- Miller Retractors	105
Adson Baby Retractors	127	Baby-Allis Forceps	62
Adson Forceps	48, 53, 68	Baby-Collin Retractors	133
Adson Needle Holder	85	Backhaus Towel Forceps	64-65
Adson Respiratories	255	Backhaus-Kocher Towel Forceps	64
Adson Retractors	128-129	Bailey Rib Contractor	236
Adson-Brown Forceps	54	Bainbridge Clamps	143
Alexander Bone Rongeurs	274	Balfour Retractors	135
Alexander Raspatories	228	Balfour-Baby Retractors	134
Allen Clamps	143, 222	Bandage Scissors	43-44
Allis Forceps	62, 138	Bane-Hartmann Bone Rongeurs	273
Allis Forceps	141	Barraquer Needle Holder	84
Aly Aesthesiometer	01	Barraquer Needle Holder (TC)	328
Amputation Saws	244-245	Barth Bone Curettes	259
Amputing Knives	12	Basiotribe Forceps	196
Anastomosis Clamps	200-201	Baumgartner Needle Holder	85
Anastomosis Clamps	204	Bayonet-Shaped Forceps	52
Anderson-Adson Retractors	128	Beckmann-Adson Retractors	129
Andrew Tongue Depressor	02	Beckmann-Eaton Retractors	129
Angle Wire Cutters	283	Beebe Scissors	41
Anuscope Speculum	154	Beer Forceps	287
Aorta-anastomosis Clamps	214-220	Bengolea Forceps	69
Arruga Forceps	53	Berger Forceps	186
Arruga Needle Holder	83	Bergmann Retractors	100
Arruga Needle Holder (TC)	328	Berliner Hammer	01
Artery Forceps	62	Bertillon Gauge	07
Asch Uterine Secreating Scoop	185	Beyer Bone Rongeurs	274
Austin Micro Forceps	45	Biemer Suction Tube	57
Autopsy and Cartilage Knives	09	Biemer Vein Scissors	18
Autopsy Knives	12	Bier Amputation Saws	245
Auvard Retractors	174	Biopsy Curettes	185
Ayre Cone Knife	13	Biopsy Forceps	186-188
<b>B</b>		Biopsy Forceps for Rectum	155
		Bishop-Harmon Forceps	53
Babcock Clamps	222	Blake Forceps	160
Babcock Forcep	139, 141	Blake Uterine Curettes	190
Baby Adson Forceps	74	Blumenthal Bone Rongeurs	273
Baby Crile Forceps	68	Bohler Bone Cutting Forceps	278
Baby Kocher Clamps	143	Bohler Bone Rongeurs	275
Baby Metzenbaum	32	Boley Gauge	07

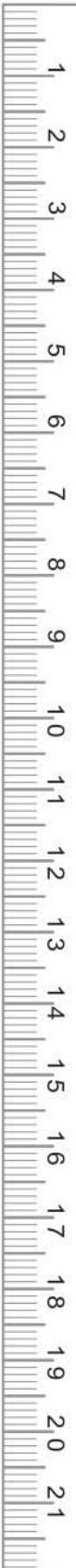

Bone Clamps	271	Bunt Forcep Hanger	65
Bone Curettes	259-262	Bushe Bone Curettes	262
Bone Cutting Forceps	226	<b>C</b>	
Bone Cutting Forceps	278-280		
Bone Holding Forceps	269-270	Cardiovescular Scissors	34
Bone Levers	247-251	Caroll Gauge	07
Bone Retractors	107	Cartilage Knives	12
Bone Rongeurs	272-277	Cartilage Scissors	39
Bonney Forceps	56	Caspar Micro Scissors	18
Bose Dilators	197	Caspar Retractors	112
Bose Retractors	100	Casper Probe	92
Bowel Scissors	39	Casper Respiratories	256
Bowman	95	Casper Rongeurs	240, 243
Boynton Needle Holder	88	Castanesa Bulldog Clamps Forceps	200
Boys Allis Forceps	138, 62	Castroviejo Needle Holder	83
Bozemann Douglas Forceps	180	Castroviejo Calliper	07
Bozemann Forceps	179-180	Castroviejo Eye Scissors	17
Bozemann Needle Holder (TC)	333	Castroviejo Forceps	53
Braun Forceps	62	Castroviejo Micro Scissors	17
Braun Forceps	181, 196	Castroviejo Needle Holder (TC)	328
Braun Probe	178	Catlin Knife	12
Braun Speculum	171	Chaput Forceps	62
Braun Stadler Scissors	38, 44	Charriier Amputation Saws	244-245
Briesky Pelvimeters	192	Cheron Forceps	59
Briesky Speculum Blades	167	Chisles	268
Briesky Wiener Modell Speculum	173	Chnad Modell Meniscus Knives	282
Brodie Probes	94	Choledochus Forceps	157
Brom	98	Cilia Forceps	57
Brophy Forceps	49, 55	Claus Van Eicken	91
Brown Forceps	54	Clip Appling Forceps	97
Bruenings Forceps	188	Cloth Scissors	43-44
Bruenings Tongue Depressor	02	Cloward Retractors	132
Bruenings Tonsil Knife	13	Coakley Trocar	164
Brunner Probe	92	Collin Clip Appling Forceps	97
Brunner Retractors	116	Collin Curette	191
Bruns Bone Curettes	261	Collin Forceps	59, 61
Bruns Scissors	44	Collin Forceps	139, 141
Buchs Retractors	112	Collin- Hartmann Retractors	105
Buchwald Tongue Depressor	02	Collin Pelvimeters	192
Buck Cotton Applicator	96	Collin Retractors	105, 133
Buck Hammer	01	Collin Speculum	165
Bulldog Clamps	66	Collin Tongue Forceps	03
Bulldog Clamps	199, 221	Comedone Extractors	14
Bumm Curette	191	Compression Forceps	81-82
Bumm Uterine Curettes	190	Cone Knives	13

Converse Needle Holder	85	De Bakey Ateriotomy Scissors	28
Converse Retractors	99	De Bakey Bulldog Clamps Forceps	199, 201
Cooley Aorta-anastomosis Clamps	216-220	De Bakey Clamps	66
Cooley Bulldog Clamps Forceps	201	De Bakey Forceps	51
Cooley Sternotomy Spreaders	234	De Bakey Forceps	142, 151
Cooley-Back Aorta-anastomosis Clamps	216	De Bakey Haemostatic Forceps	203
Cooper	91	De Bakey Harken Bulldog Clamps	206
Cooper Scissors	25	De Bakey Needle Holder (TC)	330
Cottle Bulldog Scissors	27	De Bakey Retractors	130
Cottle Chisles	265	De Bakey Rib Spreaders	232
Cottle Forceps	52	De Bakey Satinsky Vena-cava Clamps	207
Cottle Mallets	263	De Bakey Scissors (TC)	324
Cottle Osteotomes	265	De Bakey Suction Tube	290
Cottle Respiratories	254, 256	De Bakey Vena-Cava Clamps	207-211
Cottle Retractors	99, 104	De Bakey Vena-Cava Clamps	213
Cottle Scissors	35	De Bakey Vessel Scissors	33
Cotton Applicators	95-96	De Bakey-Back Vena-Cava Clamps	205
Cover Glass Forceps	48	De Bakey-Bainridge Haemostatic Forceps	202
Crafoord Clamps	224	De Bakey-Kelly Haemostatic Forceps	203
Crafoord Forceps	69	De Bakey-Mixer Anastomosis Forceps	204
Crafoord-Sellers Clamps	224	De Lee Pelvimeters	192
Cranioclast Forceps	196	Dean Scissors	35
Crile	98	Dean Scissors (TC)	325
Crile Forceps	68	Deaver Scissors	26
Crile Murray Needle Holder	85	Deaver Spatulas	118-119
Crile Needle Holder	87	Deep Form Retractors	109
Crile Retractors	105	Deep Surgery Retractors	116-117
Crile Wood Needle Holder	85	Deep Surgery Retractors	120
Crile-Wood Needle Holder (TC)	329	Dejerine Hammer	01
Cusco Speculum	165-166	Delicate Dissecting Forceps	48-49
Cushing	98	Delicate Haemostatic Forceps	67-69
Cushing Forceps	49	Delicate Scissors	20-23, 35
Cushing- Kocher Retractors	104	Delicate Tissue Forceps	53
Cushing Retractors	104	Denhardt Mouthgag	03
Cuticle Scissors	21	Denis Browne Forceps	140
Czerny Forceps	160, 183	Denis-Browne Intestinal Forceps	56
Czerny Retractors	106	Deponette Storing Case	299
<b>D</b>		Derf Needle Holder	85
		Derf Needle Holder (TC)	329
Dammschere Scissors	38-39	Derra Bulldog Clamps Forceps	201
Dandy Forceps	67	Derra-Cooley Aorta-anastomosis Clamps	217
Dardik Clamps	221	Deschamps	90-91
Daubenspeck Bone Curettes	262	Desjardins Dilators	159
Davis Dilators	198	Desjardins Forceps	77
De Bakey Aorta-anastomosis Clamps	215	Desjardins Forceps	156, 160

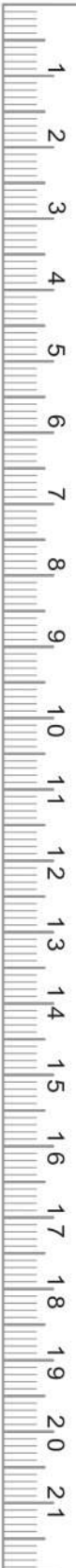

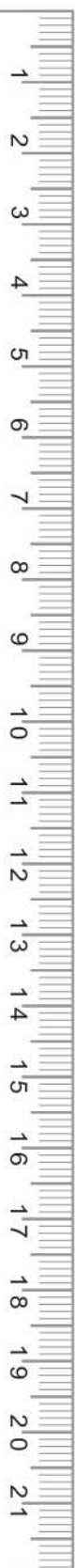

Desjardins Probe	158	Esmarch Scissors	44
Desmarres Retractors	104	Examination and Measuring Instruments	07
Diagnostic Set	04	<b>F</b>	
Dick Forceps	81	Farabeuf Respiratories	257
Dieffenbach Clips	66	Farabeuf Retractors	105
Dieffenbach Knife	10	Farrell	95
Diethrach Vena-Cava Clamps	212	Farrell Cotton Applicator	96
Diethrich Vessel Scissors	33	Faure Forceps	78
Dietrich Needle Holder (TC)	327	Favaloro Vessel Scissors	33
Dilators	198	Feilchenfeld Forceps	57
Dissecting Forceps	50, 74-77	Fergusson Mouth Gag	03
Dissecting Forceps	140-142	Fergusson Suction Tube	291
Dissecting Knives	08	Fine Operating Scissors	22
Dissecting Scissors	23, 27-32	Fine Wound Retractors	99
Dittel Dilators	159	Finocchietto Needle Holder (TC)	332
Doyen Clamps	144-146	Finochietto Forceps	76
Doyen Probes	93	Finochietto Rib Spreaders	229-2230
Doyen Respiratories	227	Finochietto-Burford Rib Spreaders	231
Doyen Retractors	121	Finsen Dilators	197
Doyen Speculum	172-173	Foerster Ballenger Forceps	60, 157
Dressing Forceps	50, 58-61	Fomn Scissors	29
Dressing-Kocher Forceps	54	Fomon Retractors	102
Duplay Forceps	182	Fomon Scissors	35
Dura and Skin Retractors	99	Forceps Jars	294
Dura Knives	14	Foregger Laryngoscope Set	06
Durotip Angle Wire Cutting Scissor	283	Fowler Tonsil Knife	13
Duval Clamps	222	Frazier Retractors	99
Duval Collin Forcep	139	Frazier Suction Tube	291
Duval Forcep	139-140	Freer Dilators	198
Duval Intestinal Forceps	56	Freer Respiratories	253-254
<b>E</b>		Freer Retractors	99
Echlin Bone Rongeurs	276	Freer-Yasargil Respiratories	254
Eiselsberg Forceps	87	Frenzel Tongue Depressor	02
Eiselsberg Scissors	40	Fritsch Retractors	121
Eiselsberg-Mathieu Needle Holder	88	<b>G</b>	
Elevators	247	Gall Duct Dilators	159
Elsching Forceps	53	Gall Duct Forceps	156-158
Embolus Grasping Forceps	198	Gall Stone Scoops	159-160
Emmet Forceps	59	Gelpi Retractors	130
Emmet Retractors	103	Gerald Forceps	49, 55
Empisiotomy Scissors	38	Gigli Handle	246
Endospecula for Cervix	177	Gigli Wire Saw	246
Engl.Mod Towel Forceps	64	Gill Forceps	53
Eppendorf Forceps	186		

Gill-Hess Forceps	53	Harvey Scissors	41
Gillies Forceps	55, 87	Harvey Wire Cutting Scissor	283
Gillies Needle Holder (TC)	334	Heaney Forceps	79-80
Gillies Retractors	99	Heaney Needle Holder	86
Glover Anastomosis Forceps	204	Heath Clip Applying Forceps	97
Glover Clamps	66	Hebra Extractor	14
Glover Vena Cava Clamps	205	Hegar Dilator	175
Goldman Fox Scissors	35	Hegar Dilator Set	176
Goligher's Scissors	39	Hegar Needle Holder	86
Good Scissors	35	Hegar Needle Holder (TC)	333
Gorney Suction Tube	291	Hegar-Baumgartner Needle Holder (TC)	329
Gosset Retractors	134	Hegar-Vascular Needle Holder (TC)	333
Gosset Retractors	134	Hegenbarth Clip Applying Forceps	97
Gouges	65, 264	Heiss Forceps	69, 76
Gouges with Hartpress Handle	268	Heister Mouth Gag	03
Graefe	98	Hemingway Bone Curettes	260
Graefe Forceps	54	Hepp-Scheidel Needle Holder (TC)	326
Graefe Knife	10	Herff Pelvimeters	193
Graefe Wound Retractors	99	Herget Forceps	155
Grave Speculum	167	Herrick Clamps	162
Gray Forceps	77, 157	Hertzler Retractors	134
Gruenwald Forceps	52	Hertzler Rib Spreaders	229
Guedel Laryngoscope Set	05	Hess Forceps	53
Guiding Probes	92	Heymann Knight Scissors	35
Gushing Rongeurs	241	Heywood Smith Tongue Forceps	03
Guthrie Retractors	99	Heywood-Smith Forceps	61
Guyon Clamps	161	Hohmann-Aldinger Bone Levers	251
Gynaecology Scissors	36-38	Holzbach Retractors	133
<b>H</b>		Hosel Retractors	113
		Hospital Wares	292-293
Haberer Spatulas	124	Hospital Wares	296-297
Haemostatic Forceps	70-73	Howarth Respiratories	254
Hajek Probe	158	Huber Forceps	188
Hajek-Kofler Punch Forceps	237	Hunt Forceps	47
Halle Bone Curettes	262	Hunter Forceps	57
Halle Dilators	198	Hurd	91
Halle Respiratories	253	Hysterectomy Forceps	79-82
Halsey Needle Holder	85	<b>I</b>	
Halsey Needle Holder (TC)	329		
Halstead Forceps	68-69	Incision Scissors	26
Halstead Mosquito Forceps	67, 69	Inge Retractors	132
Halsted Haemostatic Forceps	202	Intestinal Clamps	143-148
Harken Clamps	223	Intestinal Clamps	150
Hartmann Clamps	144	Intestinal Forceps	140-141
Hartmann Forceps	67	Intestinal Grasping Forceps	138-139

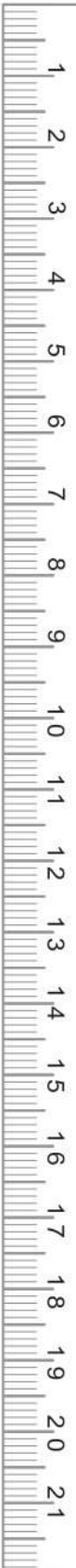

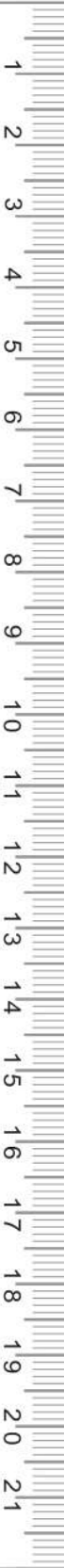

Intestinal Spatulas	123-124	Kidney Dish	295
Iowa Pelvimeters	193	Kidney Stone Forceps	163
Iris Scissors	21	Killian	95
Irrigating Cannulae	198	Killian Respiratories	254
Israel Retractors	109	Killian Speculum	152
Ives Fansler Speculum	154	Killner Scissors (TC)	325
Iwanson Gauge	07	Kilner Dissecting Scissors	28
<b>J</b>		Kilner Needle Holder	85
		Kilner Retractors	99
Jackson Borrowa Retractors	130	Kirschner Balfour Retractor	137
Jackson Speculum	170	Kirschner Probe	92
Jacobson Bone Curettes	259	Kirschner Retractor	137
Jacobson Needle Holder	83	Klapp Retractors	103
Jaegar Retractors	99	Kleinschmidt Clamps	149
Jameson Dissecting Scissors	28	Klima Rosegger Trocars	164
Jameson Needle Holder	86	Knowles Scissors	42
Jansen Bone Curettes	259-260	Kocher - Langenbeck Retractors	110
Jansen Bone Rongeurs	273-274	Kocher Clamps	145, 147
Jansen Forceps	52	Kocher Forceps	71
Jansen Respiratories	257	Kocher Needles	91
Jewellery Forceps	45	Kocher Ochsner Forceps	72
Johns-Hopkins Clips	66	Kocher Probe	92
Jones Towel Forceps	64	Kocher Retractors	104
Jonesco	91	Kocher Retractors	107-108
Joseph Nasal Knife	14	Kocher Retractors	111-112
Joseph Respiratories	252	Koenig Probe	92
Joseph Retractors	99	Kogan Specula	177
Joseph Scissors	23	Konig Bone Lever	247
Judd Allis Forceps	138	Konig Elevators	247
<b>K</b>		Freer Respiratories	253-254
		Konig Respiratories	252
Kader Spatulas	123	Konig Retractors	104
Kalt Needle Holder	83	Korpe Retractors	109
Kelly Forceps	61, 67	Krause Froceps	188
Kelly Forceps	196	Kristeller Speculum	170
Kelly Rectractors	115	Kristeller Speculum Blades	167-169
Kelly Scissors	23	Kronlein Forceps	71
Kelly Scissors (TC)	325	Kummel Spatulas	123
Kelly Speculum	154	Kustner Forceps	183
Kern-Lane Bone Holding Forceps	269	<b>L</b>	
Kerpel Bone Curettes	260		
Kerrison Punches	237	Laborde Dilators	197
Kerrison-Jacobi Punch Forceps	238	Lahey Forceps	62, 77
Kersting Forceps	151	Lahey Forceps	156, 182
Kidney Clamps	161-162	Lambotte Bone Holding Forceps	270

Lambotte Osteotomes	265-266	Lister Scissors	43
Lambotte Raspatories	228	Liston Bone Cutting Forceps	278-279
Lamina Retractors	132	Liston-Key-Horsley Bone Cutting Forceps	280
Landolt Eucleation Scissors	29	Liston-Key-Horsley Bone Rongeur	226
Landot Raspatories	256	Liston-Stillle Bone Cutting Forceps	280
Lane Bone Holding Forceps	269	Liston-Stillle Bone Rongeur	226
Lane Bone Levers	248	Littauer Scissors	40
Lane Forceps	56, 140	Littler Dissecting Scissors	27
Lane Towel Forceps	64	Lloyd-Davies Scissors	39
Lange Raspatories	252	Locklin Scissors	35
Lange Retractors	103	Locklin Scissors (TC)	325
Lange-Hohmann Bone Levers	248	Lockwood Forcep	139
Langenbeck Amputation Saws	245	Lopez-Reinke Suction Tube	291
Langenbeck Bone Lever	247	Lorna Towel Forceps	65
Langenbeck Elevator	247	Love-Gruenwald Rongeurs	240-242
Langenbeck- Green Retractors	102	Lower Forceps	77, 156
Langenbeck Knife	12	Lowman Bone Clamps	271
Langenbeck- Mannerfelt Retractors	101	Lowman-Gerester Bone Clamps	271
Langenbeck Needle Holder (TC)	336	Lowman-Hoglund Bone Clamps	271
Langenbeck Raspatories	228, 257	Lucae Forceps	52
Langenbeck Retractors	110	Lucas Bone Curettes	260
Lateral Cutting Action	284	Lucas Chisles	264
Laterally Angled Micro Scissors	19	Luer Korte Dilators	159
Lathbury-Farrell	95	Luer Retractors	105
Lathbury-Farrell Cotton Applicator	96	Lung Disseting Forceps	56
Lawrence Forceps	76	Lung Spatulas	118-119
Lazar Micro Forceps	45	Lure Bone Rongeurs	273, 275
Lebsche Wire Conductor	246	Lure-Friedmann Rongeurs	272
Lees Vena-Cava Clamps	210	Lure-Stillle Bone Rongeurs	277
Leksell-Stillle Bone Rongeurs	276		
Lempert Bone Curettes	262	<b>M</b>	
Lempert Bone Rongeurs	274	Mac Donald Raspatories	254
Leriche Spatulas	123	Magill Forceps	04
Lexer Gouges	267-268	Maier Forceps	58
Lexer Osteotomes	267	Mallets	263
Lexer Osteotomes	268	Mannerfelt Chisels	264
Lexer Scissors	31	Mannerfelt Retractors	101
Lexer Scissors (TC)	314	Mannerfet Raspatories	255
Lexer-Mini Osteotomes	267	Markwalder Rongeur	226
Lichtenberg Needle Holder (TC)	336	Marquardt Bone Rongeurs	275
Ligature Adjuster Probe	92	Marsson Needle Holder (TC)	331
Ligature Forceps	46	Martin Needle Holder (TC)	331
Ligature Forceps	46, 74-77	Martin Pelvimeters	192
Ligature Needles	90-91	Martin Probes	178
Ligature Scissors	40	Martin Retractors	117

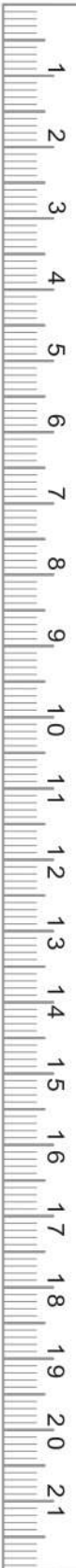

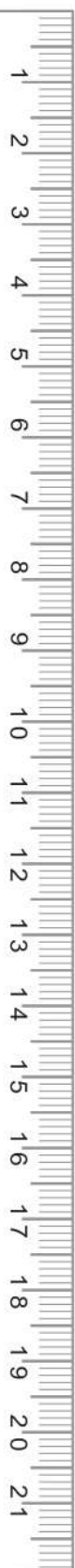

Martini Bone Curettes	259	Metzenbaum-Thorek Scissors (TC)	312
Martin-Vascular Needle Holder (TC)	327	Meyerding Retractors	116
Masing Retractors	104	Michel Clip Applying Forceps	97
Masson Luethy Needle Holder	86	Michel Modif Clip Applying Forceps	97
Masson Needle Holder	86	Micro Adson Forceps	74
Mathieu Needle Holder	88	Micro Dissecting Scissors	18
Mathieu Needle Holder (TC)	335	Micro Forceps	45-46
Mathieu Retractors	106	Micro Forceps (Light Patterns)	46
Mathieu Speculum	153, 171	Micro Halstead Forceps	67
Mathieu-Kocher Needle Holder	88	Micro Needle Holders	84
Mathieu-Kocher Needle Holder (TC)	335	Micro Scissors	17
Mathieu-Stille Needle Holder	88	Micro Surgery Forceps	83
Mayerding Retractors	102	Micro-Adson Forceps	48, 53
Mayo Forcep Hanger	65	Microscopic Forceps	48
Mayo Hegar Needle Holder	86	Middeldorph Retractors	112
Mayo Probe	158, 178	Mikulicz Forceps	73, 78
Mayo Robson Clamps	148	Mikulicz Retractors	120
Mayo Scissors	29-30	Mikulicz Spatulas	123
Mayo Scissors (TC)	306-307	Miller Laryngoscope Set	05
Mayo-Adams Retractors	127	Millin Needle Holder	88
Mayo-Harrington Scissors	30	Mixer Forceps	76-77, 156
Mayo-Harrington Scissors (TC)	321	Mixer O'shaughnessy Forceps	76
Mayo-Hegar Needle Holder (TC)	330	Mollison Retractors	127
Mayo-Lexer Scissors	31	Molt Respiratories	254
Mayo-Lexer Scissors (TC)	315	Moltgen Goniometer	07
Mayo-Noble Scissors	30	Morris Forceps	151
Mayo-Stille Scissors	29-30	Morris Retractors	115
Mayo-Stille Scissors (TC)	308	Morse Sternotomy Spreaders	233
Mc Indoe Forceps	49, 55	Moynihan Forceps	73
Mc-Kenty Respiratories	252	Moynihan Probe	158
McIntosh Laryngoscope Set	06	Muhling Respiratories	256
Mead Bone Rongeurs	274	Muller Forceps	46
Mead Mallets	263	Muller Retractors	99
Mead Respiratories	254	Muller Vessel Clips	66
Measuring Scale	07	Multipurpose Clamps	221-225
Medicine Cups	295	Museux Forceps	62
Meniscus Knives	281-282	Myomatome Knives	13
Metzenbaum Dissecting Scissors	20	Myrtle Leaf Probe	94
Metzenbaum Scissors	32	<b>N</b>	
Metzenbaum Scissors (TC)	309-311	Nail Scissors	42
Metzenbaum Scissors (TC)	319	Nail Scissors (Baby)	42
Metzenbaum-Fino Scissors (TC)	316-318	Nail Splitting Scissors	26
Metzenbaum-Fino Scissors (TC)	320	Nasal Scissors	35
Metzenbaum-Lahey Scissors (TC)	319	Needle Cases	298
Metzenbaum-s Scissors (TC)	313		



Needle Holder (TC)	334-336	<b>P</b>	
Needle Holders	83, 85-88		
Needle Holders (TC)	326-333		Parametrium Scissors (TC) 322
Neff Meniscus Knives	281		Parker Retractors 105
Negus Forceps	73		Parry-Cooley Aorta-anastomosis Clamps 220
Nelaton Probes	93		Partsch Chisels 264
Nelson Clamps	222		Partsch Respiratories 252
Nelson Forceps	56		Paulsen Respiratories 253
Nelson Metzenbaum Scissors	32		Payr Clamps 150
Nerve and Vessel Hooks	98		Payr Probe 92
Neuro-surgery Scissors	34		Pean Clamps 161
Nissen Forceps	74, 156		Pean Forceps 70-71, 73
Non-Traumatic Haemostatic Forceps	202-203		Pean Haemostatic Forceps 203
Norfolk Retractors	128		Peet Forceps 57
Norwich Retractors	128		Pelkmann Forceps 179
Noto Forceps	61		Pelvis Retractors 122
Novak Schoeckaert Biopsy Curette	185		Pennington Forceps 60
Noyes Micro Scissors	17		Percussion Hammers and Aesthesiometers 01
Nronecker	90		Peritoneum Forceps 78
<b>O</b>			Perkins Retarctors 126
			Phaneuf Forceps 79
Obstetrics Forceps	194		Phoraxsperrer Thoracic Retractors 235
Obstetrics Pelvimeters	192-193		Piccolo Model Spatula 95
Obstetrics Placenta Forceps	195-196		Pierce Antrum Trocar 164
Ochsner Probe	158		Placenta Curettes 191
Ochsner Vena-Cava Clamps	213		Plaster Cutting Scissors 44
Oldberg Rongeurs	242		Plaster Scissors 44
Olivecrona Bone Rongeurs	275		Plaster Shears 285
Olivecrona Trigeminal Knife	13		Plate Scissors 41-42
Olivecrona Wire Saw	246		Plester Retarctors 126
Olsen Hegar	87		Plester Suction Tube 291
Olsen-Hegar Needle Holder (TC)	334		Pool Suction Tube 289
Operating Scissors	36-38		Potts Smith Vessel Scissors 33
Organ Forceps	60-61, 63		Potts-Smith Needle Holder (TC) 326
Organ Forceps	140-141		Potts-Smith Scissors 34
Osteotomes	266, 268		Pozzi Forceps 181
Osteotomes Chisels	264-256		Pratt Forceps 63
Osteotomes Chisels with Hartpress Handle	267		Pratt Speculum 153
Osteotomes Gouges with Hartpress Handle	267		Prince Thomas Clamps 225
Otoscope Set	04		Probes 93-95
Overholt Fine Pattern Forceps	75		Providence-Hospital Forceps 67
Overholt Geissendoerfer Forceps	75		Punch Forceps 237-238
Overholt Mixter Forceps	74		Pylorus Clamps 150
Ovum Curettes	191	<b>Q</b>	
Ovum Forceps	195-196		

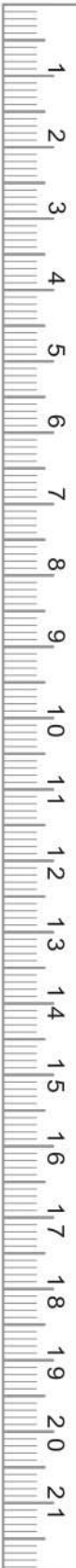

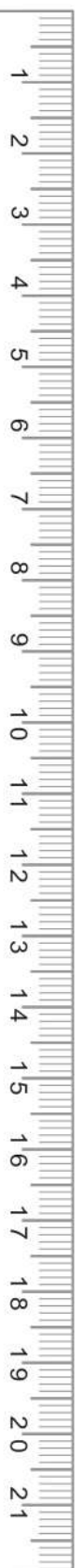

Quervain Bone Lever	247	Roser Konig Mouthgag	03
Quervain Elevator	247	Rottgen-Ruskin Bone Rongeurs	276
Quinby Scissors	23	Round Metal Boxes	295
<b>R</b>		Roux Retractors	106
		Rumel Forceps	76
Rabiner Hammer	01	Ruskin Bone Rongeurs	276
Ragnell Scissors (TC)	325	Ruskin-Liston Bone Cutting Forceps	278
Ramplcy Forceps	60	Russ.Modell Forceps	56
Randall Biopsy Curette	185	Rust Amputation Saws	244
Randall Forceps	163	Ryder Needle Holder (TC)	331
Rangell Dissecting Scissors	20	Ryder-Vascular Needle Holder (TC)	332
Rankin Forceps	68	<b>S</b>	
Rankin Haemostatic Forceps	202	Saalfeld Extractor	14
Recamier Curette	191	Saenger Forceps	195
Recamier Uterine Scoop	189	Salenius Meniscus Knives	282
Rectal Scissors	39	Sami Forceps	47
Rectal Speculums	152-153	Sarot Needle Holder (TC)	330
Retractors	115	Satinsky Clamps	223
Reill Wire Cutting Pliers	284	Satinsky Scissors	34
Resection Knives	10	Satterlee Amputation Saws	245
Respatories	252-257	Sauerbruch Needle Cases	298
Respatories with Hartpress Handle	258	Sauerbruch Retractors	111
Retractors	102-114	Sauerdruch-Coryllos Rongeur	226
Retractors	118-119	Saupe Forceps	57
Retractors	121	Scalpel Handles	15-16
Retractors with Treangle Handle	101	Schaaf Forceps	57
Reverdin Needles	89	Schaedel Towel Forceps	64
Reverdin Spatulas	124	Schede Bone Curettes	261
Reynolds Dissecting Scissors	28	Scheinmann Forceps	188
Rib Contractors	236	Schimmelbusch Hollowware	292
Rib Holding Forceps	226	Schmid Dilators	198
Rib Raspatories	227-228	Schmieden Probe	92
Rib Spreaders	229-232	Schneider Respatories	257
Rib Spreaders	236	Schoemaker-Loth Needle Holder	87
Ricard Retractors	133	Schoenborn Retractors	104
Richardson - Eastman Retractors	114	Schroder Forceps	63
Richardson Retractors	114	Schroder Forceps	181-183
Rochester Carmalt Forceps	73	Schroder Uterine Scoop	189
Rochester Ochsner Forceps	71	Schubert Forceps	186
Rochester Pean Forceps	70	Schumacher Bone Levers	251
Roeder Towel Forceps	64	Schumacher Scissors	38
Rohrschneider Needle Holder	83	Schumacher-Loth Scissors	40
Rollet Retractors	99	Schumasher Forceps	187
Rongeurs	239-243	Sciffert	95
Rose Retractors	105		

Scoviller-Richter Retractors	131	Smillie Meniscus Knives	282
Scudder Clamps	149	Smith Scissors	42
Secgond Myomatome Knife	13	Smith US Scissors	42
Sedillot Respiratories	257	Smooth Jaws Forceps	49
Seidl DBP Forceps	187	Soft Elastic Clamps	144-146
Seidl Speculum Blades	167	Somer Forceps	184
Self Retaining Laminectomy Retractors	128-129	Spatula	95
Self Retaining Laminectomy Retractors	131	Special Retractors	130
Self Retaining Retractors	125-127	Spencer Scissors	40
Sellors Rib Contractor	236	Spencer Wells Forceps	70
Sellors Rib Spreader	236	Sphincteroscopes Speculum	154
Semb Bone Holding Forceps	226	Splinter Forceps	57
Semb Bone Rongeurs	277	Sponge Forceps	58-61
Semb Raspatories	228	St Martin Forceps	53
Seme Rib Rongeur	226	St. Marks Retractors	122
Semken Forceps	49, 53	Stacke	95
Semm Retractor	136	Stellbrink Synovectomy Rongeurs	272
Semm Speculum	166	Stelzner Scissors	39
Senn Miller Retractors	105	Stenberg Tongue Depressor	02
Serrated Scissors	24	Sterberg Retractors	105
Seutin Scissors	44	Sterlizing Baskets	301-302
Obstetrics Forceps	194	Sterlizing Forceps	48
Obstetrics Pelvimeters	192-193	Sterlizing Jars	294
Obstetrics Placenta Forceps	195-196	Sternotomy Spreaders	233
Sewall Respiratories	253	Sternotomy Spreaders	234
Seyffert Speculum	166	Stevens Dissecting Scissors	20
Siebold Uterine Scissors	37	Stevens Fine Dissecting Scissors	27
Sigmoid Anastomosis Forceps	151	Stevens Vessel Scissors	27
Simon Retractors	103, 117	Stieglitz Forceps	57
Simon Retractors	174	Stille Bone Rongeurs	276
Simon Uterine Scoop	189	Stille Chisles	265
Simplex Tongue Depressor	02	Stille Clamps	162
Simpson Braun Forceps	194	Stille Gouges	265
Simpson Forceps	194	Stille Osteotomes	265-266
Simpson Probes	178	Stille Plaster Shears	286
Sims Probes	178	Stille Scissors	31
Sims Scissors	36	Stille-Aesculap Plaster Shears	285
Sims Scissors (TC)	321	Stille-Ruskin Bone Rongeurs	276
Sims Speculum	152	Stomach Clamps	149
Sims Speculum	153	Storing Cases	299-300
Sims Speculum Blades	167	Strack Scissors	41
Sims Uterine Curettes	190	Strassburger Modell Forceps	56
Sims-Maier Forceps	59	Strassmann Forceps	184
Slender Scissors	24	Stratte Needle Holder (TC)	334
Smellie Forceps	196	Strully Scissors	34

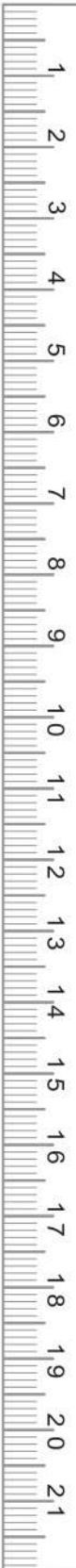

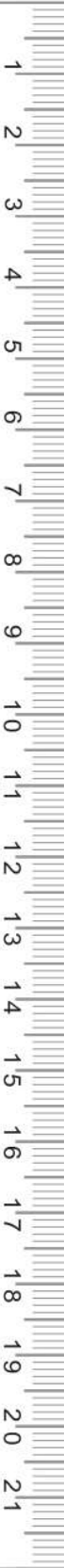

Subramanian Vena-Cava Clamps	212	Townley Gauge	07
Suction Instruments	287-291	Trachea Retractors	100
Surgical Scissors	24-26, 29	Tracheal Hooks Dilators	197
Suture Instruments	89-91	Trays	301
Suture Sets	97	Trelat Respiratories	252
Sweet Forceps	77	Trigeminal Knives	13
Sweet Forceps	156	Trocar Suction Tube	288
Syme	91	Trocars	164
Synovectomy Rongeurs	272	Troeltsch Forceps	52
Systrunk Scissors	26	Troemner Hammer	01
<b>T</b>		Trousseau Dilators	197
Tailor Scissors	42	Tubingen Model Retractors	117
Takahashi Rongeurs	239	Tuffier Rib Spreaders	229
Taylor Hammer	01	Tuffier Spatulas	124
TC Instruments	303-321	Tumor Forceps	47
TC Instruments	323-325	Tuttle Clamps	222
TC Scissors	303-305	Tuttle Forceps	56
TC Scissors	322	<b>U</b>	
Teale Forceps	183	Uffenorde Bone Curettes	260
Tendon Hooks Retractors	103	Ulrich Forceps	58
Tendon Scissors	27	Ultra Light Forceps	142
Tenotomes Knives	10-11	Umbilical Cord Scissors	38
Thole Pelvimeters	192	Universa Scissors (TC)	325
Thoms Gaylor Forceps	186	Universal Bandage Scissors	43
Thoracic Retractors	235	Unna Comedone Extractor	14
Thorek Scissors	34	US- Army Retractors	106
Thorpe Corneal Forceps	48	Uterine Curettes	190
Tiemann Bullet Forceps	63	Uterine Dilators	175
Tissue Forceps	54-56	Uterine Dilators Sets	176
Tissue Grasping Forceps	47, 60-63	Uterine Dressing Forceps	179-180
Tissue Grasping Forceps	138	Uterine Dressing Forceps	182
Tissue Grasping Forceps	140-141	Uterine Elevating Forceps	184
Tobold Tongue Depressor	02	Uterine Probes	178
Toennis Adson Scissors	28	Uterine Scoops	189
Toennis Needle Holder (TC)	336	Uterine Tenaculum Forceps	181, 183
Tongue Depressors	02	<b>V</b>	
Tonnis Dilators	198	Vacuum Curettes for Aespiration Lipectomy	287
Tonnis Needle Holder	87	Vaginal Clamps	80-82
Tonnis Retractors	99	Vaginal Retractors	173-174
Tonsil Forceps	73	Vaginal Speculum	165-167
Tonsil Knives	13	Vaginal Speculum	170
Tonsil Scissors	35	Vaginal Speculum	173-174
Tound Dilators	197	Vaginal Speculum Blades	167-169
Towel Clamps	64-65		

Vaginal Speculum for Children	171-172	Wider Tongue Depressor	02
Vaginal Speculum For Virgins	171-172	Wiener Model Probe	92
Vaginal Speculum Sets	168-169	Wilde Forceps	52
Vannas Micro Scissors	17-18	Williams Clamps	222
Vario Retractor	171	Williams Forceps	140
Vecker Eye Scissors	17	Williger Bone Curettes	259, 261
Vena-Cava Clamps	205-213	Williger Bone Lever	247
Verbrugge Bone Holding Forceps	270	Williger Elevator	247
Verbrugge-Muller Bone Levers	250	Williger Respiratories	252
Vertheim Scissors	36	Williger Retractors	102
Vessel Forceps	47	Winter Forceps	195
Vessel Hooks	98	Wire Conductors	246
Vessel Scissors	33	Wire Cutters	283
Vidal Pulus Scrapper	14	Wire Cutting Pliers	284
Vienna Pattern Speculum	173	Wire Cutting Scissors	41-42
Virchow Knife	09	Wire Cutting Scissors	283
Vise Micro Forceps	45	Wire Saws	246
Volkman Bone Curettes	259, 261	Wound Retractors	100, 174
Volkman Retractors	107-108	Wrigley Forceps	194
		Wullstein Retarctors	126
<b>W</b>		<b>Y</b>	
Wachenfeldt Clip Applying Forceps	97	Yankauer Suction Tube	290
Wagener	98	Yasargil Castroviejo Forceps	74
Wagner Bone Levers	249, 251	Yasargil Forceps	46
Wagner Meniscus Knives	281	Yasargil Micro Scissors	19
Wagner Respiratories	258	Yasargil Needle Holder	83
Wagner Rongeurs	243	Yasargil Needle Holder	84
Wagner Scissors	21	Yasargil Rongeurs	242
Walb Knife	09	Yasargil-Sami Forceps	47
Walter Osteotomes	265	Yeoman Forceps	155
Wangensteen Forceps	140	Young Tongue Forceps	03
Wangensteen Needle Holder	86		
Wangensteen Needle Holder (TC)	332	<b>Z</b>	
Wartenberg Aesthesiometer	01	Zenker Forceps	76
Wagh Forceps	55	Ziegler Milium Knife	14
Weber Aorta-anastomosis Clamps	214	Zweifel Needle Holder (TC)	336
Webster Needle Holder	85		
Webster Needle Holder (TC)	329		
Weil-Blakesley Rongeurs	239		
Weitlaner Retractors	125-126		
Wertheim Clamps	162		
Wertheim Forceps	79-80, 82		
Wertheim Hysterectomy Forceps	81		
Wertheim Cullen Forceps	82		
Wertheim Parametrium Clamps	81		

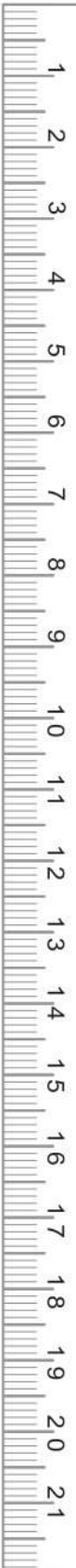

# TABLE OF CONTENTS



**Uterine Dilators, Probes  
& Forceps**  
Uterus-Dilatatoren, Sonden  
& Pinzetten  
Dilatadores uterinos, sondas  
y pinzas

Page# 179-188

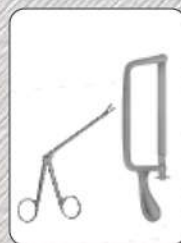

**Punches, Rongeurs & Saws**  
Stanzen, Stanzen und Sägen  
Puñetazos, Rongeurs y sierras

Page#  
241-250

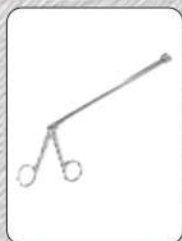

**Biopsy Forceps**  
Biopsiezangen  
Pinzas De Biopsia

Page# 189-192



**Bone Levers, Raspatories,  
Bone Curettes & Mallets**  
Knochen Hebel Raspatories,  
Scharfe Löffel & Mallets  
Las palancas óseas, Raspatories,  
Bone Curetas Mazos

Page# 251-267



**Uterine Scoops & Obstetrics Forceps**  
Uterine Scoops & Geburtshilfe Zange  
Uterina Scoops & Pinzas Obstetricia

Page# 193-202



**Osteotomes, Bone Holding Forceps,  
Bone Rongeurs & Meniscus Knives**  
Osteotome, Knochenhaltezangen,  
Bone Rongeurs & Meniscus Knives  
Osteotomos, Hueso, pinzas de sujeción  
La gubia ósea y Cuchillos de menisco

Page# 268-288

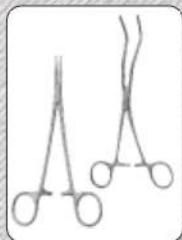

**Forceps, Clamps**  
Pinzetten, Klemmen  
Pinzas, Abrazaderas

Page# 203-229



**Wire Cutting Pliers, Plaster Shears,  
Suction Instruments & Hollow Wares**  
Wire Cutting Pliers, Gips Shears,  
Sauginstrumente & Hollow Wares  
Alicates de corte de alambre, tijeras Yeso,  
Instrumentos de la succión y artículos para el hueco

Page# 289-310



**Rib Raspatories & Rib Spreaders**  
Rib Raspatories & Rippensperrer  
Raspatories Rib Rib y separadores

Page#  
230-240



**TC Instruments**  
TC Instrumente  
Instrumentos TC

Page# 311-344

# TABLE OF CONTENTS



**Percussion Hammers & Aesthesiometers  
and other instruments.**  
Perkussionshämmer & Ästhesiometer  
und anderen Instrumenten.  
Martillos de percusión y Aesthesiometer  
y otros instrumentos. Page# 1-7

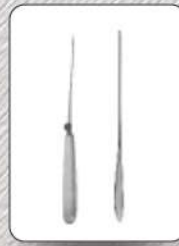

**Suture Instruments & Probes**  
Naht-Instrumente & Sonden  
Los instrumentos y sondas de Page# 91-100



**Scalpel, Knives and  
Scalpel Handles**  
Skalpell, Messer und  
Skalpellgriffe  
Bisturi, cuchillos y  
bisturi Mangos Page# 8-16

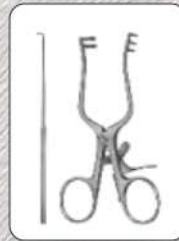

**Hooks & Retractors**  
Haken & Retraktoren  
Ganchos y retractores Page# 99-140

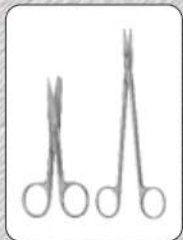

**Scissors**  
Schere  
tijeras Page# 17-44



**Intestinal & Rectal Instruments**  
Darm & Rektum  
Instrumentos  
intestinal y rectal Page# 141-157

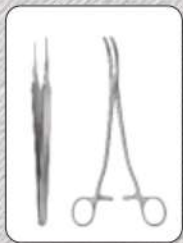

**Forceps, Clamps**  
Pinzetten, Klemmen  
Pinzas, Abrazaderas Page# 45-83



**Biopsy Forceps, Gall Duct Forceps,  
Kidney Clamps & Trocars**  
Biopsiezangen,  
Gallenwegefunktionsstörungen  
Pinzetten,  
Kidney Klemmen & Trokare  
Pinzas de biopsia, pinzas  
Gall conductos,  
Las abrazaderas de riñón y  
Trocars Page# 158-168



**Needle Holders**  
Nadelhalter  
Porta Agujas Page# 84-90



**Vaginal Specula**  
Vaginalspekula  
Espéculos Vaginales Page# 169-178

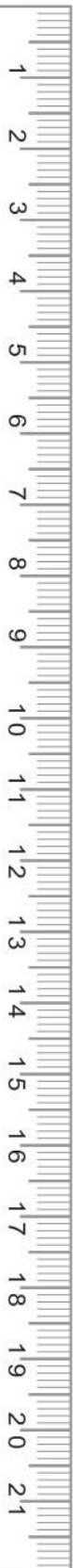

Subramanian Vena-Cava Clamps	212	Townley Gauge	07
Suction Instruments	287-291	Trachea Retractors	100
Surgical Scissors	24-26, 29	Tracheal Hooks Dilators	197
Suture Instruments	89-91	Trays	301
Suture Sets	97	Trelat Respiratories	252
Sweet Forceps	77	Trigeminal Knives	13
Sweet Forceps	156	Trocar Suction Tube	288
Syme	91	Trocars	164
Synovectomy Rongeurs	272	Troeltsch Forceps	52
Systrunk Scissors	26	Troemner Hammer	01
<b>T</b>		Trousseau Dilators	197
Tailor Scissors	42	Tubingen Model Retractors	117
Takahashi Rongeurs	239	Tuffier Rib Spreaders	229
Taylor Hammer	01	Tuffier Spatulas	124
TC Instruments	303-321	Tumor Forceps	47
TC Instruments	323-325	Tuttle Clamps	222
TC Scissors	303-305	Tuttle Forceps	56
TC Scissors	322	<b>U</b>	
Teale Forceps	183	Uffenorde Bone Curettes	260
Tendon Hooks Retractors	103	Ulrich Forceps	58
Tendon Scissors	27	Ultra Light Forceps	142
Tenotomes Knives	10-11	Umbilical Cord Scissors	38
Thole Pelvimeters	192	Universa Scissors (TC)	325
Thoms Gaylor Forceps	186	Universal Bandage Scissors	43
Thoracic Retractors	235	Unna Comedone Extractor	14
Thorek Scissors	34	US- Army Retractors	106
Thorpe Corneal Forceps	48	Uterine Curettes	190
Tiemann Bullet Forceps	63	Uterine Dilators	175
Tissue Forceps	54-56	Uterine Dilators Sets	176
Tissue Grasping Forceps	47, 60-63	Uterine Dressing Forceps	179-180
Tissue Grasping Forceps	138	Uterine Dressing Forceps	182
Tissue Grasping Forceps	140-141	Uterine Elevating Forceps	184
Tobold Tongue Depressor	02	Uterine Probes	178
Toennis Adson Scissors	28	Uterine Scoops	189
Toennis Needle Holder (TC)	336	Uterine Tenaculum Forceps	181, 183
Tongue Depressors	02	<b>V</b>	
Tonnis Dilators	198	Vacuum Curettes for Aespiration Lipectomy	287
Tonnis Needle Holder	87	Vaginal Clamps	80-82
Tonnis Retractors	99	Vaginal Retractors	173-174
Tonsil Forceps	73	Vaginal Speculum	165-167
Tonsil Knives	13	Vaginal Speculum	170
Tonsil Scissors	35	Vaginal Speculum	173-174
Tound Dilators	197	Vaginal Speculum Blades	167-169
Towel Clamps	64-65		



Vaginal Speculum for Children	171-172	Wider Tongue Depressor	02
Vaginal Speculum For Virgins	171-172	Wiener Model Probe	92
Vaginal Speculum Sets	168-169	Wilde Forceps	52
Vannas Micro Scissors	17-18	Williams Clamps	222
Vario Retractor	171	Williams Forceps	140
Vecker Eye Scissors	17	Williger Bone Curettes	259, 261
Vena-Cava Clamps	205-213	Williger Bone Lever	247
Verbrugge Bone Holding Forceps	270	Williger Elevator	247
Verbrugge-Muller Bone Levers	250	Williger Respiratories	252
Vertheim Scissors	36	Williger Retractors	102
Vessel Forceps	47	Winter Forceps	195
Vessel Hooks	98	Wire Conductors	246
Vessel Scissors	33	Wire Cutters	283
Vidal Pulus Scrapper	14	Wire Cutting Pliers	284
Vienna Pattern Speculum	173	Wire Cutting Scissors	41-42
Virchow Knife	09	Wire Cutting Scissors	283
Vise Micro Forceps	45	Wire Saws	246
Volkman Bone Curettes	259, 261	Wound Retractors	100, 174
Volkman Retractors	107-108	Wrigley Forceps	194
		Wullstein Retarctors	126
<b>W</b>		<b>Y</b>	
Wachenfeldt Clip Applying Forceps	97	Yankauer Suction Tube	290
Wagener	98	Yasargil Castroviejo Forceps	74
Wagner Bone Levers	249, 251	Yasargil Forceps	46
Wagner Meniscus Knives	281	Yasargil Micro Scissors	19
Wagner Respiratories	258	Yasargil Needle Holder	83
Wagner Rongeurs	243	Yasargil Needle Holder	84
Wagner Scissors	21	Yasargil Rongeurs	242
Walb Knife	09	Yasargil-Sami Forceps	47
Walter Osteotomes	265	Yeoman Forceps	155
Wangensteen Forceps	140	Young Tongue Forceps	03
Wangensteen Needle Holder	86		
Wangensteen Needle Holder (TC)	332	<b>Z</b>	
Wartenberg Aesthesiometer	01	Zenker Forceps	76
Wagh Forceps	55	Ziegler Milium Knife	14
Weber Aorta-anastomosis Clamps	214	Zweifel Needle Holder (TC)	336
Webster Needle Holder	85		
Webster Needle Holder (TC)	329		
Weil-Blakesley Rongeurs	239		
Weitlaner Retractors	125-126		
Wertheim Clamps	162		
Wertheim Forceps	79-80, 82		
Wertheim Hysterectomy Forceps	81		
Wertheim Cullen Forceps	82		
Wertheim Parametrium Clamps	81		

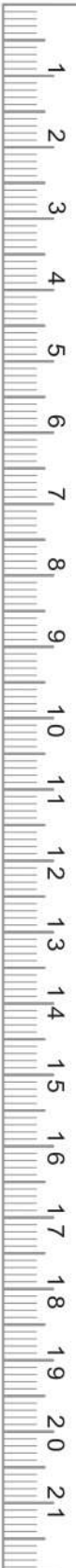



**MATU BROTHERS  
SURGICAL**



# Contact Us

 +92 342 8797600

 [info@matubrothers.com](mailto:info@matubrothers.com)

 Makta Post Office Kotli Bawa,  
Faqir Chand Teh, Pasrur  
Sialkot. 51310 pakistan.